



A

**Dissertation Report**

**On**

**“OPTIMISATION OF UNSCHEDULED INTERCHANGE IN THERMAL  
POWER STATION A WIN-WIN SOLUTION ”**

By

Sanjiv Kumar Jha

Enrollment Number: 500017979

Guided By

Mr K Sanjeev Nair.

AVP, Reliance Power Ltd, Sasan, MP

A DISSERTATION REPORT SUBMITTED IN PARTIAL FULFILLMENT OF THE  
REQUIREMENTS FOR  
EXECUTIVE MASTER OF BUSINESS ADMINISTRATION (NAME OF THE  
PROGRAM) OF  
UNIVERSITY OF PETROLEUM & ENERGY STUDIES, INDIA



CENTRE FOR CONTINUING EDUCATION  
UNIVERSITY OF PETROLEUM & ENERGY STUDIES, DEHRADUN

## ACKNOWLEDGEMENT

This is to acknowledge with thanks the help, guidance and support that I have received during the Dissertation.

I have no words to express a deep sense of gratitude to the management of Sasan Power Ltd for giving me a opportunity to pursue my Dissertation, and in particular Mr Sanjeev Nair, for his able guidance and support.

I must thank all my colleagues for their valuable support.

*Sanjiv Kumar Jha*

Sanjiv Kumar Jha

House No: 7E5/G2

Sasan colony

Singrauli (MP)

Mob:7828014620

Date :05/10/2015

Place : Singrauli (MP)

K. Sanjeev ,  
AVP, C&I  
Reliance Power Ltd,  
Gram: Sidhi Khurd  
Post: **Tiyara**, **Tehsil: Waidhan**,  
Distt: Singrauli  
Pin: 486886  
Madhya Pradesh, India

**Subject:-**Willingness for Guiding Dissertation of Sanjiv Kumar Jha (Registration No.500017979).

Dear Sir,

Sanjiv Kumar Jha is registered for EMBA (Power Management), with the University of Petroleum & Energy Studies, Dehradun in July 2011-2014 batch.

I hereby give my acceptance to guide the above student through the Dissertation work "OPTIMISATION OF UNSCHEDULED INTERCHANGE IN THERMAL POWER STATION A WIN-WIN SOLUTION ", which is a mandatory requirement for the award of EMBA degree.

Thanking You  
Yours Sincerely,

*Sanjeev K*

## TABLE OF CONTENTS

S. No.	Particulars	Page No.
	Acronyms	6
	Executive Summary	7
 <b>Chapter-1</b>	<b>Introduction</b>	<b>10</b>
	• Pre ABT Scenario	10
	• Availability Based Tariff	11
	• Time of Use Tariff	12
	• Objective	13
	• Problem Domain	13
	• Limitation	14
	• Conclusion	15
	• Recommendations	15
 <b>Chapter-2</b>	<b>Literature Review</b>	<b>16</b>
	• Indian Power Sector	16
	• Indian Power Scenario	21
	• Demand Trends	22
	• Grid Security	26
	• Power Supply Scenario	26
	• Standard for Power Frequency India	27
	• Initiative of CERC for Improving Frequency In the Grid	27
	• Significant developments and concern in Indian Grid	30
	✓ Growing Expectation of Consumer	30
	✓ Impact of Frequency on Voltage	30
	✓ Frequency Fluctuation and Response of Generator	31
	✓ Volume of Unscheduled Interchange	31
	• Comparison of Permissible Frequency in Other Countries in View of India	33
	• Issues for Discussion with respect to Tightening of Frequency Band	35

	• Other Issues Related to Grid Security	35
<b>Chapter-3</b>	<b>Research Design, Methodology and Plan</b>	<b>43</b>
	• Calculation of Block Avg Frequency	43
	• Auto Load Set-point Correction	44
	• Determination of Profit-Loss	46
	• Other Variables	46
	✓ Time Cycle	47
	✓ Instant Frequency Measurement	47
	✓ Plant Process Limitation	47
	• Data Sheets	48
	✓ Unit with UI Correction	69
	✓ Unit Without UI Correction	90
	✓ UI Rates	91
	• Data Collection and Sampling Method	91
	• Source of Data	91
	• Sample Size	91
	• Method of Data collection	91
	• Tools and Technique of Analysis	91
<b>Chapter-4</b>	<b>Analysis</b>	<b>92</b>
<b>Chapter-5</b>	<b>Interpretation of Results</b>	<b>94</b>
<b>Chapter-6</b>	<b>Conclusion and Scope for Future Work</b>	<b>96</b>
	<b>Bibliography</b>	<b>98</b>
	<b>Appendix</b>	<b>100</b>

## LIST OF TABLE OF CONTENTS AND ILLUSTRATION

S. No.	Particulars	Page No.
01.	Snapshot of the Proposed UMPP	20
02.	Indicative Emission Levels Achievable in Mundra UMPP	20
03.	List of UMPP for which Bids have been finalized	20
04.	Source of Electricity in India by Installed Capacity as of 2013	21
05.	Electricity Production in India till 2013	22
06.	Growth of Installed Capacity in India	22
07.	All India (Anticipated)Power Supply Position in FY 2015-16	22
08.	Growth of Electricity Consumption in India	24
09.	State wise All India Installed Capacity as of July 2015	25
10.	Standards for Power Frequency in India	27
11.	Operating Range for frequency Specified in IEGC	28
12.	Under Frequency Relay Setting adopted in India	30
13.	Rate of Change of Frequency Relay Setting adopted in Indian Grid	30
14.	Permissible Frequency Band in Other Countries	33
15.	Unit with UI Correction	48
16.	Unit without UI Correction	69

## ACRONYMS

ABT	- Availability Based Tariff
BEE	- Bureau of Energy Efficiency
CERC	- Central Electricity Regulatory Commission
ELD	- Economic Load Dispatch
ERC	- Electricity Regulatory Commission
FDS	- Functional Design Specification
MYT	- Multi Year Tariff Order
NREC	- Notified Rate of Energy
OAC	- Open Access Customer
PLF	- Plant Load Factor
RLDC	- Regional Load Dispatch Centre
SGS	- State Generating Stations
SLDC	- State Load Dispatch Centre
UI	- Unscheduled Interchange
IEGC	- Indian Electricity Grid Code
ToU	- Time-of-use tariff
CPP	- Critical Peak Pricing
FiT	- Feed-in Tariff

## **EXECUTIVE SUMMARY**

The main objective of the deregulated power sector market is to decrease the cost of electricity through competition. The market environment typically consists of a pool and privately negotiated contracts. The performance of a market is measured by its social welfare, also called Social benefit (SB). Social benefit is the difference of society's willingness to pay for energy and its cost. So in the deregulated environment, the objective functions consist of bid functions offered by generation companies and retailers to the independent system operator (ISO).

The term Availability Based Tariff stands for a rational tariff structure for power supply from generating stations, on a contracted basis. The unique feature of this tariff, to tackle the peculiar problems of grid operation in India, is the frequency-linked pricing of the Unscheduled Interchange (UI). In ABT mechanism, fixed and variable cost components of power plant are treated separately. Unscheduled Interchange in a time block for a generating station/load means its total actual generation/demand minus its total scheduled generation/total scheduled drawl. All payments on account of Unscheduled Interchange charges levied under Grid regulations and these shall be utilized for serving of investment of transmission schemes or for providing ancillary services including but not only limited to load generation balancing during low grid frequency to ensure grid security and safety. Indian energy exchange is India's first electricity exchange. It is a transparent, neutral, nationwide, automated, online electricity trading platform. It enables efficient price discovery and price risk management for participants of the electricity market including industries eligible for open access through anonymous platform.

The Indian Electricity Grid Code (IEGC) is a regulation made by the Central Electricity Regulatory Commission. It lays down the rules, guidelines and standards to be followed by various persons and participants in the system to plan, develop, maintain and operate the power system, in the most secure, reliable, economic and efficient manner, while facilitating healthy competition in the generation and supply of electricity. India has a huge power shortage (unmet electricity demand), which is retarding the nation's progress. The mechanism of Unscheduled Interchange (UI) if properly deployed can help in bringing more power into the electricity grids, enabling the utilities to meet additional consumer load, both short-term and long-term, and significantly reduce the quantum of load-shedding. UI has generally been known as the third component Availability Based Tariff (ABT), which was introduced in India at the regional level in 2002-03. A real-time balancing market based on real-time price signals derived from frequency to maintain system frequency sufficiently close to nominal value has been proposed. It is used for settlement of real-time imbalance between demand and supply during a trading period in deregulated markets. A frequency-linked bidding structure for the frequency regulation service market has been proposed. A dynamic simulation model is developed for a two-area interconnected power system that incorporates the features of frequency regulation services to examine the performance of the optimum regulation contracts. Conventional Generation Scheduling GS algorithm is modified to incorporate frequency dependant part of tariff. Hourly frequency and load using Statistical Analysis and Artificial Neural Network (ANN) respectively



are estimated. A technique for determining loop flows and designating contribution factors to utilities in a power system has been discussed. Contribution factors are used to assess the participation of generating utilities in causing unscheduled flow and assigning equitable charge or compensation to utilities based on participation. In a competitive electricity market, the sellers and buyers submit bids for energy buy and sell. The bids are generally in the form of price and quantity quotations and specify how much seller or buyer is willing to buy or sell and at what price. After the bids are available to the market operator it settles the market based on optimization. Frequency-based tariffs have been proposed in India to improve unscheduled interchange. Such tariffs apply steeply inclined prices to deviations from frequency. A very low price is assigned to high frequencies, and a very high price is assigned to low frequencies. The Wide Open Load Following (WOLF) Method is similar to the UI Pricing Method except that it includes time error, steeper prices, and a continuous pricing formula for reactive power. Prices also vary with location due to line losses and transmission constraints and. Thus, WOLF provides a technique for compensating specifically for unscheduled transmission usage unlike the UI Pricing Method. Introduce a technique that shifts the focus from contributions of transmission companies to contributions of GENCOs specifically. The difference between actual flows and scheduled flows along different contract paths is used to estimate minor loop flows in an energy grid using various techniques to minimize the  $p^{\text{th}}$  norm, such as ordinary least squares, robust regression. Contribution factors with different weighting mechanisms for each utility are then determined. A suggested "take-or-pay" charge could then be levied to participating GENCOs according to their unscheduled flow contribution as estimated using the minor loop flow assumptions and associated errors. Availability Based Tariff comprises of three components:

- Capacity Charge
- Energy Charge
- Unscheduled
- 

Inter-change (UI) Charge. In case there are deviations from the schedule of generation or withdrawal of power, this third component of ABT comes into picture. Deviations from schedule are determined in 15-minute time blocks through special metering and priced according to the system condition prevailing at that time. If the frequency is above 50 Hz, (nominal frequency in Indian System), UI rate will be low and if it is below 50 Hz, it will be high. As long as the actual generation / drawl is according to the given schedule, the third component of ABT is zero. In case of deviation, market participants have to pay UI charge according to the specified frequency dependent rate. According to current guidelines of CERC, this rate varies in frequency range of 49.5 Hz and 50.2 Hz

*This paper proposes that there is a scope as well as the need of optimizing the system to maximize the earning and minimize the loss from thermal power station point of view, while on the other hand it will further improve the Grid Frequency and Quality of the power which the ultimate aim of the Power Grid Transmission national level.*

## Chapter 1

### INTRODUCTION

*"Maximization of station earning with stable grid frequency is the ultimate outcome of the study."*

Electricity tariff setting is a primary instrument of economic regulation. Tariff provides economic signals, which determine the volume and nature of the demand and supply of power. It is not surprising therefore that a considerable portion of the power sector reform effort is expended on rationalizing tariffs. Through this paper we aim to discuss the potential for alternative ways of charging for electricity and providing concessions to improve the affordability of essential electricity use, facilitate the equitable, efficient and full recovery of the cost of supplying electricity and provide clear information to consumers regarding the impact of their electricity use. Many of the existing tariff elements have been formulated over the years as a result of available technology. In reviewing the electricity tariff structures it is therefore important to consider some of the developments in technology particularly with respect to metering which may facilitate a greater variety in tariff structures now or in the future.

**Keywords:** tariff, availability based tariff (ABT), unscheduled interchange (UI), time-of-use tariff (ToU), critical peak pricing (CPP), real-time pricing (RTP), feed-in tariff (FiT), dynamic pricing, smart metering.

Tariff means the schedule of rates or charges. Tariff, in case of electric supply, means the schedule or rates framed for supply of electrical energy to various classes of consumers. The main objective of the tariff is to distribute equitably the cost of supplying energy among the various classification of use. A tariff must recover cost of capital investment in generating, transmitting and distributing equipment, cost of operation, supplies and maintenance of equipment, cost of metering equipment, billing, collection costs and miscellaneous services & should provide with a satisfactory return on the total capital investment. The principal factors involved in fixing of a tariff structure are expected to ensure a return is secured from each customer, the consumers are encouraged to make more extended use of electricity, the tariff should be simple & capable of explaining to the public, the consumers are charged according to what the energy costs, the consumers are encouraged to use electricity during off-peak hours, and penalized for high loads demanded at system peak by making a provision for higher demand charges & the customers are penalized for poor power factor.

#### PRE-ABT SCENARIO

Implementation of Availability Based Tariff for Central generating stations in India was recommended by M/s ECC of USA in 1994, under a study sponsored by the World Bank and ADB. A proposal for ABT, as a three-part tariff, was first mooted in the year 1994 in a report

submitted by an International Consultant (ECC Report) to the Government of India. The introduction of Availability Based Tariff came about on 1st July, 2002 from the Western Region. Prior problem in the Indian power sector was not only the shortage of power but also the difficulty in performing grid operations due to acute indiscipline shown by the generators as well as the beneficiaries. The generators could pump as much power in the grid as they could irrespective of the frequencies and still get acknowledged for the wastage of the valuable resource. The regional grid operators ironically had a horrifying time trying to get generators backed down to protect the turbines of the same generator causing the situation. On the other end the stated utilities could overdraw from the grid even during deficit and still escape creating a chaos and despair all around. There was this persistent problem of frequent power over-draw from one of the State Beneficiaries, leading to grid instability. The transmission corridors were getting congested while bringing the excess amount of power from the remote locations to the load centers. There was a poor frequency regime followed i.e. low frequency during peak periods while during off-peak periods high frequency. The reason attributed to this is the existence of perverted incentives in the tariff regime at that time such as Recovery of capacity charges based on PLF and no differential payment for deviations from schedule.

### **Availability Based Tariff**

Availability means the readiness of the generating station to deliver. The term availability in the present context could be defined as the MW capability of the generator for supplying to the grid after accounting for the planned and unplanned outages and deration due to non-availability of auxiliaries, fuel and water. Availability Based Tariff is concerned with the tariff structure for bulk power and is aimed at bringing about more responsibility and accountability in power generation and consumption through a scheme of incentives and disincentives. ABT stands for a rational tariff structure for power supply from generating stations on a contracted basis. The ABT is a tariff for transactions between the operator of the power plant or station and the beneficiary. ABT is a three-part tariff:

**Capacity charges (fixed cost):** full recovery at normative availability.

**Energy charge (variable cost):** up to scheduled energy, at normative tariff

**Unscheduled Interchange:** deviation from schedule, rate linked to frequency.

The fixed cost elements are interest on loan, return on equity, depreciation, O&M expenses, insurance, taxes and interest on working capital. The payment of fixed cost to the generating company is linked to availability of the plant i.e. its capability to deliver MWs on a day-by-day basis. The total amount payable to the generating company over a year towards the fixed cost depends on the average availability (MW delivering capability) of the plant over the year. In case the average actually achieved over the year is higher than the specified norm for plant availability, the generating company gets a higher payment

Energy charge comprises of the variable cost (i.e., fuel cost) of the power plant for generating energy as per the given schedule for the day. It may specifically be noted that energy charge (at the specified plant-specific rate) is not based on actual generation and plant output, but on scheduled generation. In case there are deviations from the schedule (e.g., if a power plant delivers 600 MW while it was scheduled to supply only 500 MW), the energy charge payment

would still be for the scheduled generation (500 MW), and the excess generation (100 MW) would get paid for at a rate dependent on the system conditions prevailing at the time.

The UI charges are payable depending upon what is deviated from the schedule and also subject to the grid conditions at that point of time. UI charges are levied for difference in its Actual and Scheduled Generation/drawl. UI is payable or receivable depending on over or under generation. Rate of UI linked to average frequency of 15 minutes time block. UI charges are levied for difference in its Actual and Scheduled Generation/drawl. UI will be worked out for each 15 minutes time block. Charges for UI are frequency linked and are payable/ recoverable depending on grid frequency .

Under this system UI charges will be payable, if:

- a generator generates more than the schedule, thereby increasing the frequency;
- a generator generates less than the schedule, thereby decreasing the frequency;
- a beneficiary overdraws power, thereby decreasing the frequency;
- a beneficiary under-draws power, thereby increasing the frequency

Under the frequency linked UI regime, charges will be paid to or levied on the generator for any deviations from schedules. These could be favorable if the generator is under-generating at high frequency or over generating at low frequency and unfavorable if the generator is over-generating at high frequency or under generating at low frequency condition.

In a deficit scenario, where all the generators would have been fully dispatched up to their declaration, the generators would utilize the design margins of the machine to achieve generation higher than their installed capacity (when the full capacity has been declared in the first instance) and thus would be able to inject more than their installed capacity into the system at time of low frequency conditions. This mechanism provides for the right price signals to the generators to generate more when the frequency is low and vice versa and also pre-empts the possibility of unwanted generation at higher frequency because the variable cost payment is now linked to scheduled generation and not actual generation

#### **TIME OF-USE TARIFF**

Comprises prices set in advance that vary among a small number of time periods (typically three) during the day and are presented as a customer tariff; the prices usually have a significant (30 to 40%) differential between peak, off-peak and shoulder periods. ToU tariffs are offered or imposed on customers primarily by the electricity industry to improve the operation of electricity systems, but are also often promoted by pricing regulators with the objective of increasing economic efficiency. The time-varying pricing implications for emissions reduction can differ significantly between countries depending on the type of electricity generation system in place. Essentially the electricity generation system comprises base-load plants that operate almost continuously and are the source of most of the country's electrical energy, and the load-following plants (intermediate and peaking plants) that are used to respond to shorter-term fluctuations in demand. Time-varying pricing could be seen as a mechanism for sharing some of the price risks between the electricity retailer and the customer. Higher income households are

better able to respond to the price differentials for a positive financial outcome because they have access to and can afford efficient and programmable appliances. Disadvantaged households spend a proportionately higher percentage of their income on energy costs (despite using less energy overall than other households) and so are more exposed to the negative impacts of time-varying pricing. Today, a number of countries such as Canada, Australia, Italy, Netherlands and Japan offer smart metering and time varying tariff pricing. A number of incumbent utilities are considering new necessary product and service options (i.e. TOU contracts, RTP contracts, curtail-able service menus, price risk protection, economic development rates, fixed bill rate options, two-part tariffs and cross-product bundling). Utilities have experimented with time differentiated pricing models for some time now. Hardware availability for real-time electricity monitoring was considered as a challenge in early implementation. Despite this fact, both consumer and utility experience with dynamic pricing was considered to be positive early on. Today, a number of smart metering solutions are available in market today enabling dynamic tariff schemes to be implemented. Equilibrium models based on mixed complementarity to estimate ex ante TOU prices. A multi-agent simulation approach has been considered to understand response of different customers to TOU pricing. Consumers, Retailer, Network Operator and Producer are considered as the stakeholders of the market

## **OBJECTIVE**

The main objective of the study is to develop a mechanism which can optimize the UI ie regulate the generation in order to maintain the grid transmission discipline which ultimately improve the quality of power received by the consumer and at the same time improves the profitability of the generation units.

The mechanism if can be used by each of the generating unit it will necessarily improves the power quality i.e. the frequency and will help to maintain the frequency in a predefined band.

## **PROBLEM DEFINATION**

The study of the existing literature involved the study of the various reports and practices which has been followed in almost in every units to meet out the CERC norms to maintain the frequency in Range and further UI optimisation to maximise the earning and reduce the penalty . Two units of the same capacity has been studied where one unit has the proposed solution implemented and the other unit the normal practice were continued.

The difference in the block level has been studied. Their outcomes has been converted to the earning .The said modification has been tuned as per the observation and limitation of the generating units.

The traditional method for UI Optimization has following practical issues:

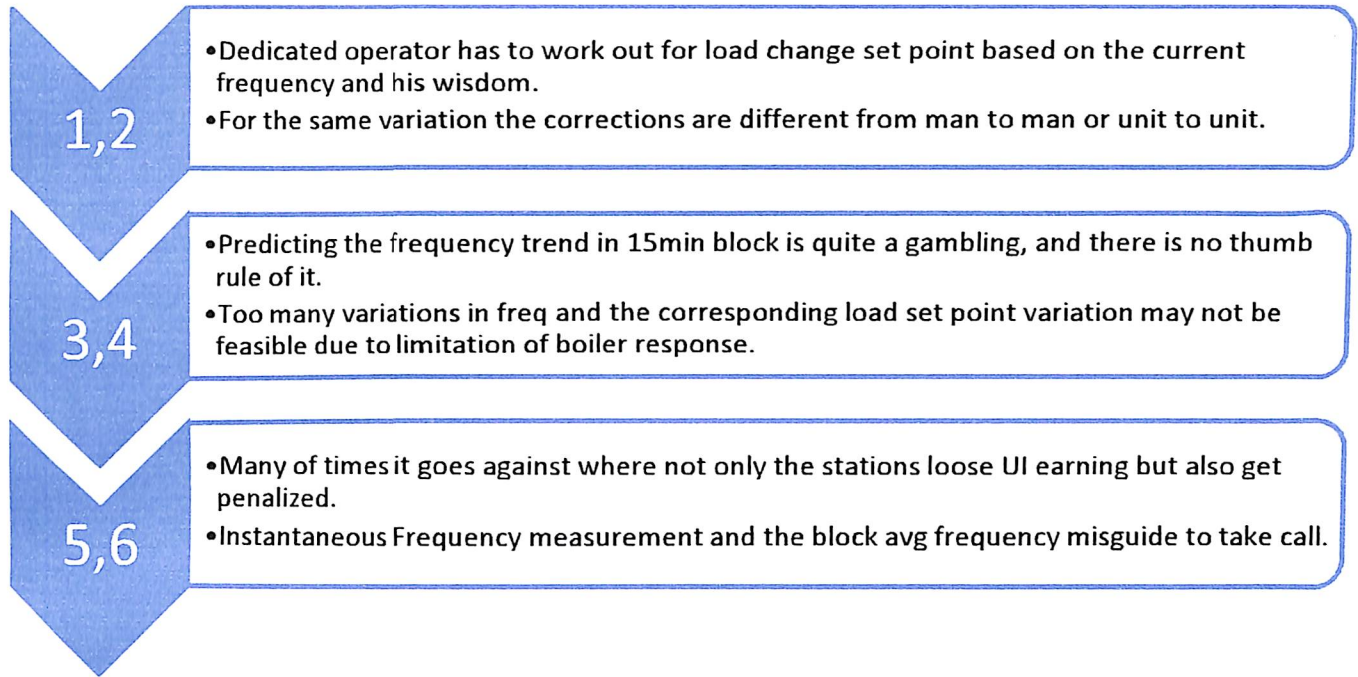

Figure 1

### Limitation

The said project is mainly suitable for coal based thermal power station. Further to this there is a limitation of load correction that can be applied or initiated due to the inherent lag in the boiler pressure control. One must apply the correction based on as per the capability of the boiler. Block timing must strictly match with the GPS time, so that there is no deviation in the ABT block time and the DCS time.

## Conclusion

A properly designed system will regulate the Load Set Point of the Unit based on the Block Average Frequency ie if the avg frequency of the block will be higher than the threshold frequency (say 50.04 Hz) the load set point will automatically reduced to the limit possible (a limit which is predefined by the desk operator) and vice versa.

By doing this it will help the grid to maintain the frequency in the specified band and further will increase the earning of the station by feeding more when frequency is less and feeding less when frequency is high hence saving the fuel.

*“Maximization of station earning with stable grid frequency is the ultimate outcome of the study.”*

## Recommendations

Considering the above facts it is very clear that there is a scope as well as the need of optimizing the system to maximize the earning and minimize the loss from thermal power station point of view while on the other hand it will further improve the Grid Frequency and Quality of the power which the ultimate aim of the Power Grid Transmission.

If a logic can be made in view of the above issues which can address the error in frequency as its measured variable and correct the MW set point accordingly as close as possible. If all the connected station follows the same the overall frequency will improve and for any deviation will further improve the earning and reduce the losses of the Power Station.

**So ultimately is a “WIN-WIN” case.**

The claimed system may be implemented in almost all the thermal power station.

The system will necessarily impact the generation more preciously will increase the earnings for the same generation and will reduce the fine for more injecting at high frequency and vice versa which will further reflect in the sp coal consumption also.

As far as grid is concerned the quality of power ie the frequency band will improve provided the more number of stations feeding the grid will use the existing system.

There is no any harm as far as real life is concern with the said system.

## Chapter 2

# LITERATURE REVIEW

### INDIAN POWER SECTOR

Recessionary blues have started hitting India's Power Sector. Not long ago the Power Sector was being considered in India as the fastest growing sector. The opportunities it offered were tremendous. Many middle managers left their cushy jobs with state run enterprises and joined newbie outfits, hoping to cash on. It was not long ago. But six months down the barrel the scenario has undergone a sea change. Most of the private promoters have resorted to "Go Slow" mode. Very few companies are going ahead with the same zest and vigour which was witnessed in the market not long ago.

Not long ago, even in the midst of recessionary voices, the economists presented very rosy picture of India's Power Sector. They described Power Sector to be the last sector to get affected by slow down. But, six months is pretty long time. All major promoters have been affected and are facing drying up of funds. With demands in other sector logging negative growth, the power project developers are revisiting their plans

Most worried are the equipment manufacturers, who have booked orders from India's private sector projects. With private entities in India, declaring their intent to go slow, the equipment manufacturers have also decided to suspend or shelve their manufacturing for these private projects. This scenario has benefited India's Central and state run power companies, who have witnessed prices of equipment dropping by whopping 25% in last 3-4 weeks. Every equipment manufacturer in competitive market is trying to grab orders from central utilities so that their operations remain stable and payments are not blocked.

So this is an aberration or a beginning of the end of Power Sector boom. It is true that India's Power Sector needs tremendous investments. With 7-8% CAGR, India needs to have regular investments in Power Sector, in future. But Government alone can not sustain the capacity additions which the next five 5-year plans have envisaged. Private sector and funding agencies need to come together to resurrect India's Private sector with little bit of nudge from Government.

The nature of risks affecting investment decisions has changed significantly with the liberalization of electricity markets, and this has implications for determining the required rate of return on generating investments. Financial risks are perceived and assessed differently. The markets for fuel are undergoing substantial changes on many levels. Also the coal markets are under influence from new factors. Environmental policy is also playing a more and more important role that is likely to significantly influence fossil fuel prices in the future. Security of energy supply remains a concern for most of the Power Producers of country and government



must take necessary amendment in the policy for keeping the generating investment intact in the future.

The two fundamental characteristics of power delivered to a customer are frequency and voltage. The short run supply-demand balance is indicated by frequency. Frequency is a 'public good' having large external effects. Stable operation of the interconnected power system, requires that frequency be maintained within a certain tolerance as defined by the standards adopted in a country.

The Unscheduled Mechanism (UI) enforced in the interstate sale-purchase of power has succeeded in transforming the fabric of the Indian power system operation in a manner unparalleled. Nonetheless, categorizing the scheme as a disciplinary and penal mechanism would be like missing bull's eye wide off the mark. UI rate is much more than what meets the eye. The paper argues that the mechanism is primarily a real-time balancing mechanism which is something very important as far as Power Grid discipline and Quality is concerned and on the other hand a particularly developed mechanism for optimization the UI in plant level will be a very important tool /instrument to achieve economy and efficiency at the macro level.

The main objective of the deregulated power sector market is to decrease the cost of electricity through competition. The market environment typically consists of a pool and privately negotiated contracts. The performance of a market is measured by its social welfare, also called social benefit (SB). Social benefit is the difference of society's willingness to pay for energy and its cost. So in the deregulated environment, the objective functions consist of bid functions offered by generation companies and retailers to the independent system operator (ISO).

The term Availability Based Tariff stands for a rational tariff structure for power supply from generating stations, on a contracted basis. The unique feature of this tariff, to tackle the peculiar problems of grid operation in India, is the frequency-linked pricing of the Unscheduled Interchange (UI). In ABT mechanism, fixed and variable cost components of power plant are treated separately. Unscheduled Interchange in a time block for a generating station/load means its total actual generation/demand minus its total scheduled

Generation/total scheduled drawl. All payments on account of Unscheduled Interchange charges levied under Grid regulations and these shall be utilized for serving of investment of transmission schemes or for providing ancillary services including but not only limited to load generation balancing during low grid frequency to ensure grid security and safety. Indian energy exchange is India's first electricity exchange. It is a transparent, neutral, nationwide, automated, online electricity trading platform. It enables efficient price discovery and price risk management for participants of the electricity market including industries eligible for open access through anonymous platform. The Indian Electricity Grid Code (IEGC) is a regulation made by the Central Electricity Regulatory Commission. It lays down the rules, guidelines and standards to be followed by various persons and participants in the system to plan, develop, maintain and operate the power system, in the most secure, reliable, economic and efficient manner, while facilitating healthy competition in the generation and supply of electricity. India has a huge power shortage (unmet electricity demand), which is retarding the nation's progress. The mechanism of Unscheduled Interchange (UI) if properly deployed, can help in bringing more power into the electricity grids, enabling the utilities to meet additional consumer load, both

short-term and long-term, and significantly reduce the quantum of load-shedding. UI has generally been known as the third component Availability Based Tariff (ABT), which was introduced in India at the regional level in 2002-03. A real-time balancing market based on real-time price signals derived from frequency to maintain system frequency sufficiently close to nominal value has been proposed. It is used for settlement of real-time imbalance between demand and supply during a trading period in deregulated markets. A frequency-linked bidding structure for the frequency regulation service market has been proposed. A dynamic simulation model is developed for a two-area interconnected power system that incorporates the features of frequency regulation services to examine the performance of the optimum regulation contracts. Conventional Generation Scheduling GS algorithm is modified to incorporate frequency dependant part of tariff. Hourly frequency and load using Statistical Analysis and Artificial Neural Network (ANN) respectively are estimated. A technique for determining loop flows and designating contribution factors to utilities in a power system has been discussed. Contribution factors are used to assess the participation of generating utilities in causing unscheduled flow and assigning equitable charge or compensation to utilities based on participation. In a competitive electricity market, the sellers and buyers submit bids for energy buy and sell. The bids are generally in the form of price and quantity quotations and specify how much seller or buyer is willing to buy or sell and at what price. After the bids are available to the market operator it settles the market based on optimization. Frequency-based tariffs have been proposed in India to improve unscheduled interchange. Such tariffs apply steeply inclined prices to deviations from frequency. A very low price is assigned to high frequencies, and a very high price is assigned to low frequencies. The Wide Open Load Following (WOLF) Method is similar to the UI Pricing Method except that it includes time error, steeper prices, and a continuous pricing formula for reactive power. Prices also vary with locational due to line losses and transmission constraints. Thus, WOLF provides a technique for compensating specifically for unscheduled transmission usage unlike the UI Pricing Method introduces a technique that shifts the focus from contributions of transmission companies to contributions of GENCOs specifically. The difference between actual flows and scheduled flows along different contract paths is used to estimate minor loop flows in an energy grid using various techniques to minimize the pth norm, such as ordinary least squares, robust regression. Contribution factors with different weighting mechanisms for each utility are then determined. A suggested "take-or-pay" charge could then be levied to participating GENCOs according to their unscheduled flow contribution as estimated using the minor loop flow assumptions and associated errors. Availability Based Tariff comprises of three components: (a) Capacity Charge (b) Energy Charge (c) Unscheduled Interchange (UI) Charge. In case there are deviations from the schedule of generation or withdrawal of power, this third component of ABT comes into picture. Deviations from schedule are determined in 15-minute time blocks through special metering and priced according to the system condition prevailing at that time. If the frequency is above 50 Hz, (nominal frequency in Indian System), UI rate will be low and if it is below 50 Hz, it will be high. As long as the actual generation / drawl is according to the given schedule, the third component of ABT is zero. In

case of deviation, market participants have to pay UI charge according to the specified frequency dependent rate. According to current guidelines of CERC, this rate varies in frequency range of 49.5 Hz and 50.2 Hz.

For the past few years both the Central Gov. and the State Governments have adopted the process of tariff based competitive bidding for allotting thermal power plants. But there are many problems associated with this process that are demoralizing the developers. These problems need urgent attention of the policy makers and some of the problems are:

- Shortage of fuel(coal & gas);
- Changes in international laws;
- Environment and forest clearance;
- Land acquisition problem;
- Delay in placement of orders – mainly Civil Works and Balance of Plants(BOPs);
- Inadequate deployment of construction machinery;
- Contractual dispute between project developer and contractor and their sub vendors/ sub-contractors;
- Shortage of skilled manpower for erection and commissioning;
- Inadequate infrastructure facilities like reliable construction power supply and constraints in transportation of heavy equipment;
- Similar bid document for both gas and coal based power plants.
- Continuous variation of Foreign Exchange Rates.

Levelling tariff is one of the important aspects among others which are affecting not only the UMPP but the whole Power Sector in way of making it suffering. This is not as case with any individual power producer but the whole sector even the biggest producers are finding it difficult to manage in the margin provided.

The nature of risks affecting investment decisions has changed significantly with the liberalization of electricity markets, and this has implications for determining the required rate of return on generating investments. Financial risks are perceived and assessed differently. The markets for fuel are undergoing substantial changes on many levels. Also the coal markets are under influence from new factors. Environmental policy is also playing a more and more important role that is likely to significantly influence fossil fuel prices in the future. Security of energy supply remains a concern for most of the Power Producers of country and government must take necessary amendment in the policy for keeping the generating investment intact in the future.

Table 1

Snapshot of the proposed UMPPs			
Project	Consumer States	Status	Bid Tariff
Mundra, Gujarat	<b>Coastal Projects</b> Gujarat, Maharashtra, Rajasthan, Punjab and Haryana	Project awarded to Tata Power Limited. PPA signed	Rs 2.26/kWh
Krishnapatnam, Andhra Pradesh	Andhra Pradesh, Karnataka, Tamil Nadu, Madhya Pradesh	Project awarded to Reliance Power Limited. PPA signed	Rs 2.33/kWh
Tadri, Karnataka	Maharashtra, Rajasthan, Tamil Nadu, Kerala and Karnataka	Initial stage - Site to be identified	-
Cheyur, Tamil Nadu	-	Initial stage - Site to be identified	-
Girya, Maharashtra	Maharashtra, Rajasthan, Madhya Pradesh, Chhattisgarh and Karnataka	Initial Stage- Site to be identified	-
Sasan, Madhya Pradesh	<b>Pithead Projects</b> Delhi, Haryana, Uttar Pradesh, Rajasthan, Punjab, Uttarakhand and Madhya Pradesh	Project awarded to Reliance Power PPA signed	Rs 1.19/kWh
Sundergarh District, Orissa	-	Initial stage - coal block allocated, Land to be allotted by State Govt	-
Tilaiyadam, Jharkhand	Delhi, Uttar Pradesh, Punjab, Haryana, Rajasthan, Madhya Pradesh, Gujarat, Maharashtra, Bihar and Jharkhand	RFQ/RFP Stage. PPA Signed	-
Akaltara, Chhattisgarh	-	Initial Stage- Site to be finalised	-

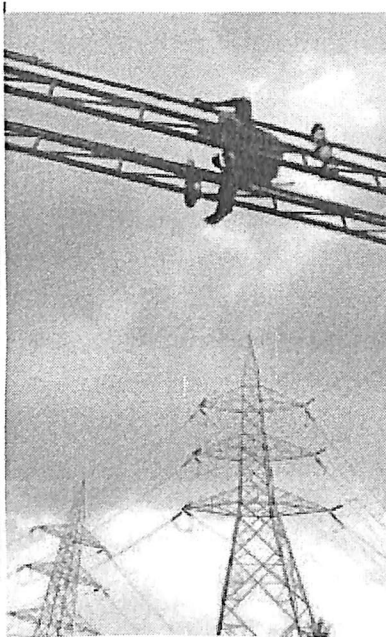

Table 2

Indicative emission levels achievable in Mundra UMPP			
Parameter	Expected Emission	Indian Limit	World Bank Norm
SO <sub>2</sub>	400 TPD	700 TPD	450 TPD
NO <sub>x</sub>	687.6 mg/Nm <sup>3</sup>	No applicable standards	750 mg/Nm <sup>3</sup>
SPM	50 mg/Nm <sup>3</sup>	100 mg/Nm <sup>3</sup>	50 mg/Nm <sup>3</sup>

Mg/Nm<sup>3</sup> = milligram per normal cubic meter, NO<sub>x</sub> = nitrogen oxide, SO<sub>2</sub> = sulphur dioxide.

SPM = suspended particulate matter, TPD = tonnes per day.

Source: ADB Environmental Assessment report of Mundra UMPP

Table 3

List of UMPPs for which bids have been finalised				
Project	No. of bidders		Lowest bid tariff (Rs/ kWh)	Highest bid tariff (Rs/ kWh)
	National	International		
Mundra UMPP	6	0	2.26	3.74
Krishnapatnam	3	0	2.33	4.20
Sasan UMPP	8	1	1.20	2.25

Within this framework and limitations, the study suggests a way to enhance some extra earning and at the same time helping the grid to maintain its power quality. The study indeed highlights the changing conditions and its impact on power projects.

For a power station with a low tariff and high volume it becomes even compulsory to minimize the losses as maximum as possible. UI gives an opportunity to enhance the earning and if the same can be optimized as claimed by the study it will necessarily give an edge towards the survival of such a big and contributing power generating organization.

### INDIAN POWER SCENARIO

As far as present Indian Power Scenario is concerned the utility electricity sector in India had an installed capacity of 278.733 GW as of 30 September 2015. Renewable Power plants constituted 28% of total installed capacity and Non-Renewable Power Plants constituted the remaining 72%. The gross electricity generated by utilities is 1,106 TWh (1,106,000 GWh) and 166 TWh by captive power plants during the 2014–15 fiscal. The gross electricity generation includes auxiliary power consumption of power generation plants. India became the world's third largest producer of electricity in the year 2013 with 4.8% global share in electricity generation surpassing Japan and Russia.

During the year 2014-15, the per capita electricity generation in India was 1,010 kWh with total electricity consumption (utilities and non utilities) of 938.823 billion or 746 kWh per capita electricity consumption. Electric energy consumption in agriculture was recorded highest (18.45%) in 2014-15 among all countries. The per capita electricity consumption is lower compared to many countries despite cheaper electricity tariff in India.

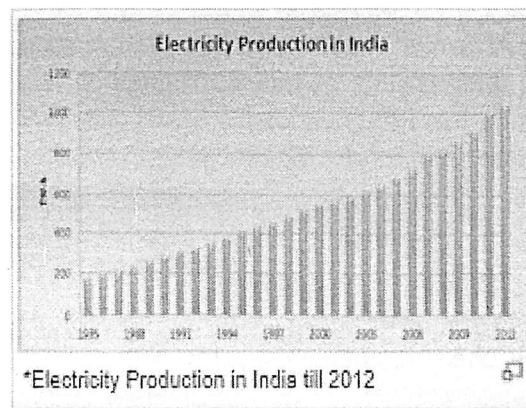
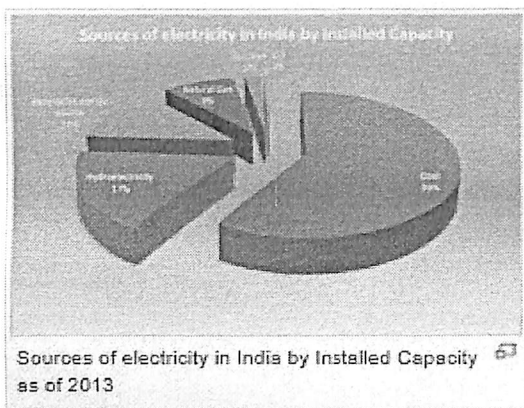

The growth of the Indian Power Sector is as follows:

Utility power [ edit ]

Growth of Installed Capacity in India<sup>(10)</sup>

Installed Capacity as on	Thermal (MW)				Nuclear (MW)	Renewable (MW)			Total (MW)	% Growth (on yearly basis)
	Coal	Gas	Diesel	Sub-Total Thermal		Hydel	Other Renewable	Sub-Total Renewable		
31-Dec-1947	756	-	98	854	-	508	-	508	1,362	-
31-Dec-1950	1,004	-	149	1,153	-	560	-	560	1,713	8.59%
31-Mar-1956	1,597	-	228	1,825	-	1,061	-	1,061	2,886	13.04%
31-Mar-1961	2,436	-	300	2,736	-	1,917	-	1,917	4,653	12.25%
31-Mar-1966	4,417	137	352	4,903	-	4,124	-	4,124	9,027	18.80%
31-Mar-1974	8,652	165	241	9,058	640	6,966	-	6,966	16,664	10.58%
31-Mar-1979	14,875	168	164	15,207	640	10,833	-	10,833	26,680	12.02%
31-Mar-1985	26,311	542	177	27,030	1,095	14,460	-	14,460	42,585	9.94%
31-Mar-1990	41,236	2,343	165	43,764	1,565	18,307	-	18,307	63,636	9.89%
31-Mar-1997	54,154	6,562	294	61,010	2,225	21,658	902	22,560	85,795	4.94%
31-Mar-2002	62,131	11,163	1,135	74,429	2,720	26,269	1,628	27,897	105,046	4.49%
31-Mar-2007	71,121	13,692	1,202	86,015	3,900	34,654	7,760	42,414	132,329	5.19%
31-Mar-2012	1,12,022	18,381	1,200	1,31,603	4,780	38,990	24,503	63,493	199,877	9.00%
31-Mar-2014	1,45,273	21,782	1,200	1,68,255	4,780	40,532	31,692	72,224	2,45,259	10.77%
31-Mar-2015 <sup>(2)</sup>	1,64,636	23,062	1,200	188,898	5,780	41,267	35,777	77,044	271,722	10.8%

## DEMAND TRENDS

During the fiscal year 2014-15, the electricity generated in utility sector is 1,030.785 billion KWh with a short fall of requirement by 38.138 billion KWh (-3.6%) against the 5.1% deficit anticipated. The peak load met was 141,180 MW with a short fall of requirement by 7,006 MW (-4.7%) against the 2.0% deficit anticipated. In a May 2015 report, India's Central Electricity Authority anticipated, for the 2015-16 fiscal year, a base load energy deficit and peaking shortage to be 2.1% and 2.6% respectively. Southern and North Eastern regions are anticipated to face energy shortage up to 11.3%. The marginal deficit figures clearly reflect that India would become electricity surplus during the 12th five-year plan period.

All India (Anticipated) Power Supply Position in FY2015-16<sup>(27)</sup>

Region	Energy			Peak Power		
	Requirement (MU)	Availability (MU)	Surplus(+)/Deficit(-)	Demand (MW)	Supply (MW)	Surplus(+)/Deficit(-)
Northern	355,794	354,540	-0.4%	54,329	54,137	-0.4%
Western	353,068	364,826	+3.3%	48,479	50,254	+3.7%
Southern	313,248	277,979	-11.3%	43,630	35,011	-19.8%
Eastern	124,610	127,066	+2.0%	18,507	19,358	+4.6%
North-Eastern	15,703	13,934	-11.3%	2,650	2,544	-4.0%
<b>All India</b>	<b>1,162,423</b>	<b>1,138,346</b>	<b>-2.1%</b>	<b>156,862</b>	<b>152,754</b>	<b>-2.6%</b>

Despite an ambitious rural electrification program, some 400 million Indians lose electricity access during blackouts. While 80% of Indian villages have at least an electricity line, just 52.5% of rural households have access to electricity. In urban areas, the access to electricity is 93.1% in 2008. The overall electrification rate in India is 64.5% while 35.5% of the population still live without access to electricity.

According to a sample of 97,882 households in 2002, electricity was the main source of lighting for 53% of rural households compared to 36% in 1993.

The 17th electric power survey of India report claims:

Over 2010–11, India's industrial demand accounted for 35% of electrical power requirement, domestic household use accounted for 28%, agriculture 21%, commercial 9%, public lighting and other miscellaneous applications accounted for the rest.

- The electrical energy demand for 2016–17 is expected to be at least 1,392 Tera Watt Hours, with a peak electric demand of 218 GW.
- The electrical energy demand for 2021–22 is expected to be at least 1,915 Tera Watt Hours, with a peak electric demand of 298 GW.

If current average transmission and distribution average losses remain same (32%), India needs to add about 135 GW of power generation capacity, before 2017, to satisfy the projected demand after losses.

McKinsey claims that India's demand for electricity may cross 300 GW, earlier than most estimates. To explain their estimates, they point to four reasons:

- India's manufacturing sector is likely to grow faster than in the past
- Domestic demand will increase more rapidly as the quality of life for more Indians improve
- About 125,000 villages are likely to get connected to India's electricity grid
- Blackouts and load shedding artificially suppresses demand; this demand will be sought as revenue potential by power distribution companies

A demand of 300 GW will require about 400 GW of installed capacity, McKinsey notes. The extra capacity is necessary to account for plant availability, infrastructure maintenance, spinning reserve and losses.

In 2010, electricity losses in India during transmission and distribution were about 24%, while losses because of consumer theft or billing deficiencies added another 10–15%.

According to two studies published in 2004, theft of electricity in India, amounted to a nationwide loss of \$4.5 billion. This led several states of India to enact and implement regulatory, and institutional framework; develop a new industry and market structure; and privatize distribution. The state of Andhra Pradesh, for example, enacted an electricity reform law; unbundled the utility into one generation, one transmission, and four distribution and supply

companies; and established an independent regulatory commission responsible for licensing, setting tariffs, and promoting efficiency and competition. Some state governments amended the Indian Electricity Act of 1910 to make electricity theft a cognizable offence and impose stringent penalties. A separate law, unprecedented in India, provided for mandatory imprisonment and penalties for offenders, allowed constitution of special courts and tribunals for speedy trial, and recognised collusion by utility staff as a criminal offence. The state government made advance preparations and constituted special courts and appellate tribunals as soon as the new law came into force. High quality metering and enhanced audit information flow was implemented. Such campaigns have made a big difference in the Indian utilities' bottom line. Monthly billing has increased substantially, and the collection rate reached more than 98%. Transmission and distribution losses were reduced by 8%.

Power cuts are common throughout India and the consequent failure to satisfy the demand for electricity has adversely effected India's economic growth.

Growth of Electricity Consumption in India<sup>(1991-2)</sup>

Consumption as on	Total (in GWh)	% of Total						Per-Capita Generation (in kWh) <sup>(clarification needed)</sup>
		Domestic	Commercial	Industrial	Traction	Agriculture	Misc	
31-Dec-1947	4,182	10.11%	4.26%	70.78%	6.62%	2.99%	5.24%	16.3
31-Dec-1950	5,610	9.36%	5.51%	72.32%	5.49%	2.89%	4.44%	18.2
31-Mar-1956	10,150	9.20%	5.38%	74.03%	3.99%	3.11%	4.29%	30.9
31-Mar-1961	16,804	8.88%	5.05%	74.67%	2.70%	4.96%	3.75%	45.9
31-Mar-1966	30,455	7.73%	5.42%	74.19%	3.47%	6.21%	2.97%	73.9
31-Mar-1974	55,557	8.36%	5.38%	68.02%	2.76%	11.36%	4.13%	126.2
31-Mar-1979	84,005	9.02%	5.15%	64.81%	2.60%	14.32%	4.10%	171.6
31-Mar-1985	124,569	12.45%	5.57%	59.02%	2.31%	16.83%	3.83%	228.7
31-Mar-1990	195,098	15.16%	4.89%	51.45%	2.09%	22.58%	3.83%	329.2
31-Mar-1997	315,294	17.53%	5.56%	44.17%	2.09%	26.65%	4.01%	464.6
31-Mar-2002	374,670	21.27%	6.44%	42.57%	2.16%	21.80%	5.75%	671.9
31-Mar-2007	525,672	21.12%	7.65%	45.89%	2.05%	18.84%	4.45%	559.2
31-March-2012	785,194	22.00%	8.00%	45.00%	2.00%	18.00%	5.00%	883.6
31-March-2013	824,301	22.29%	8.83%	44.40%	1.71%	17.89%	4.88%	914.4
31-March-2014	881,562	22.95%	8.80%	43.17%	1.75%	18.19%	5.14%	957
31-March-2015	938,823	23.53%	8.77%	42.10%	1.79%	18.45%	5.37%	1010.0 <sup>Provisional</sup>



**State-wise All India installed capacity as of July 2015<sup>(5)</sup>**  
(including allocated shares in joint and central sector utilities)

State/Union Territory	Thermal (in MW)				Nuclear (in MW)	Renewable (in MW)			Total (in MW)	% of Total
	Coal	Gas	Diesel	Sub-Total Thermal		Hydel	Other Renewable	Sub-Total Renewable		
Maharashtra	24,669.27	3,475.93	-	28,145.20	690.14	3,331.84	6,205.65	9,537.49	38,372.83	13.91%
Gujarat	16,010.27	6,806.09	-	22,816.36	559.32	772.00	4,802.40	5,574.4	28,950.08	10.49%
Madhya Pradesh	11,126.39	257.18	-	11,383.57	273.24	3,223.66	1,670.34	4,894.00	16,550.81	6.00%
Chhattisgarh	13,193.49	-	-	13,193.49	47.52	120.00	327.18	447.18	13,688.19	4.96%
Goa	326.17	48.00	-	374.17	25.80	-	0.05	0.05	400.02	0.14%
Dadra & Nagar Haveli	44.37	27.10	-	71.47	8.46	-	-	-	79.93	0.03%
Daman & Diu	36.71	4.20	-	40.91	7.38	-	-	-	48.29	0.02%
<b>Central - Unallocated</b>	<b>1,622.35</b>	<b>196.91</b>	<b>-</b>	<b>1,819.26</b>	<b>228.14</b>	<b>-</b>	<b>-</b>	<b>-</b>	<b>2,047.40</b>	<b>0.74%</b>
<b>Western Region</b>	<b>67,029.01</b>	<b>10,815.41</b>	<b>-</b>	<b>77,844.42</b>	<b>1,840.00</b>	<b>7,447.50</b>	<b>13,005.62</b>	<b>20,453.12</b>	<b>100,137.54</b>	<b>36.29%</b>
Rajasthan	9,400.72	825.03	-	10,225.75	573.00	1,719.30	4,710.50	6,429.8	17,228.55	6.24%
Uttar Pradesh	11,677.95	549.97	-	12,227.92	335.72	2,168.30	989.86	3,158.16	15,721.80	5.70%
Punjab	6,444.88	288.92	-	6,733.80	208.04	3,145.13	503.42	3,648.55	10,590.38	3.84%
Haryana	6,527.53	560.29	-	7,087.82	109.16	1,456.83	138.60	1,595.43	8,792.41	3.19%
Delhi	5,001.87	2,366.01	-	7,367.88	122.08	822.05	34.71	856.76	8,346.72	3.03%
Himachal Pradesh	152.02	61.88	-	213.90	34.08	3,421.51	728.91	4,150.42	4,398.40	1.59%
Uttarakhand	399.50	69.35	-	468.85	22.28	2,441.82	244.32	2,686.14	3,177.27	1.15%
Jammu & Kashmir	329.32	304.14	-	633.46	77.00	1,805.21	156.53	1,961.74	2,672.20	0.97%
Chandigarh	32.54	15.32	-	47.86	8.84	62.32	5.04	67.36	124.06	0.04%
<b>Central - Unallocated</b>	<b>977.19</b>	<b>290.35</b>	<b>-</b>	<b>1,267.54</b>	<b>129.80</b>	<b>754.30</b>	<b>-</b>	<b>754.30</b>	<b>2,151.64</b>	<b>0.78%</b>

<b>Southern Region</b>	<b>30,842.50</b>	<b>4,962.78</b>	<b>917.48</b>	<b>36,722.76</b>	<b>2,320.00</b>	<b>11,398.03</b>	<b>15,245.11</b>	<b>26,643.14</b>	<b>65,685.90</b>	<b>23.81%</b>
West Bengal	8,083.83	100.00	-	8,183.83	-	1,248.30	131.45	1,379.75	9,563.84	3.47%
Odisha	6,753.04	-	-	6,753.04	-	2,166.93	116.55	2,283.48	9,036.52	3.28%
DVC	7,160.66	90.00	-	7,250.66	-	193.26	-	193.26	7,443.92	2.70%
Bihar	2,516.24	-	-	2,516.24	-	129.43	114.12	243.55	2,759.79	1.00%
Jharkhand	2,404.93	-	-	2,404.93	-	200.93	20.05	220.98	2,625.91	0.95%
Sikkim	92.10	-	-	92.10	-	174.27	52.11	226.38	318.48	0.12%
<b>Central - Unallocated</b>	<b>1,572.07</b>	<b>-</b>	<b>-</b>	<b>1,572.07</b>	<b>-</b>	<b>-</b>	<b>-</b>	<b>-</b>	<b>1,572.07</b>	<b>0.57%</b>
<b>Eastern Region</b>	<b>28,582.87</b>	<b>190.00</b>	<b>-</b>	<b>28,772.87</b>	<b>-</b>	<b>4,113.12</b>	<b>434.54</b>	<b>4,547.66</b>	<b>33,320.53</b>	<b>12.08%</b>
Assam	187.00	718.62	-	905.62	-	429.72	34.11	463.83	1,369.45	0.50%
Tripura	18.70	538.82	-	557.52	-	62.37	21.01	83.38	640.90	0.23%
Meghalaya	17.70	105.14	-	122.84	-	356.58	31.03	387.61	510.45	0.19%
Arunachal Pradesh	12.35	43.06	-	55.41	-	97.57	104.64	202.21	257.62	0.09%
Manipur	15.70	67.98	36.00	119.68	-	80.98	5.45	86.43	206.11	0.07%
Nagaland	10.70	46.35	-	57.05	-	53.32	29.67	82.99	140.04	0.05%
Mizoram	10.35	38.29	-	48.64	-	34.31	36.47	70.78	119.42	0.04%
<b>Central - Unallocated</b>	<b>37.50</b>	<b>104.44</b>	<b>-</b>	<b>141.94</b>	<b>-</b>	<b>127.15</b>	<b>-</b>	<b>127.15</b>	<b>269.09</b>	<b>0.10%</b>
<b>North-Eastern Region</b>	<b>310.00</b>	<b>1,662.70</b>	<b>36.00</b>	<b>2,008.70</b>	<b>-</b>	<b>1,242.00</b>	<b>262.38</b>	<b>1,504.38</b>	<b>3,513.08</b>	<b>1.27%</b>
Andaman & Nicobar	-	-	40.05	40.05	-	-	10.35	10.35	50.40	0.02%
Lakshadweep	-	-	-	-	-	-	0.75	0.75	0.75	0.00%
<b>Islands</b>	<b>-</b>	<b>-</b>	<b>40.05</b>	<b>40.05</b>	<b>-</b>	<b>-</b>	<b>11.10</b>	<b>11.10</b>	<b>51.15</b>	<b>0.02%</b>
<b>Total</b>	<b>167,707.88</b>	<b>22,962.15</b>	<b>993.53</b>	<b>191,663.56</b>	<b>5,780</b>	<b>41,997.42</b>	<b>36,470.64</b>	<b>78,468.06</b>	<b>275,911.62</b>	<b>100.00%</b>

The total installed utility power generation capacity as on 31 March 2015 with sector wise & type wise break up is as given below.<sup>[53]</sup>

Sector	Coal	Gas	Diesel	Total	Nuclear	Hydro	RES	Grand Total (MW)
Central	481,30.00	7,519.73	0	55,649.73	5,780.00	11,091.43	0	72,521.16
State	58,100.50	6,974.42	602.61	65,677.53	0	27,482.00	3,803.67	96,963.20
Private	58,405.38	8,568.00	597.14	67,570.52	0	2,694.00	31,973.29	102,237.81
All India	164,635.88	23,062.15	1,199.75	188,897.78	5,780.00	41,267.43	35,776.96	271,722.17

## GRID SECURITY

### NEED OF TIGHTENING OF FREQUENCY BAND AND OTHER MEASURES

Power frequency reflects the load generation balance in the grid at a particular instant. Frequency is one of the most important parameters for assessment of the security of power system and the quality of power supply in any grid. It is to be maintained within the specified range in which all the electrical equipments are designed to perform safely and efficiently. Handling imbalances is an integral part of market design. In India, the balancing market is frequency dependent and market design must complement reliability. This discussion paper focuses on grid frequency and other issues related to grid security in India

## POWER SUPPLY SCENARIO

India is one of the largest synchronous interconnections in the world. The installed generation capacity as on 31st Jan 2011 is 170.23 GW. The revised target for generation capacity addition in 11th five year plan is 62 GW. The projected peak shortage and energy shortage in March 2012 is 6.5% and 2% respectively

Table 1: Anticipated Power Supply Scenario in 2012

Period	Peak Demand (MW)	Peak Availability (MW)	Deficit (-) / Surplus (+) (MW)	Deficit (-) / Surplus (+) (%)
2011-12	152746	142765	-9981	-6.5
	Energy Requirement (MU)	Energy Availability (MU)	Deficit (-) / Surplus (+) (MU)	Deficit (-) / Surplus (+) (%)
2011-12	968659	948836	-19823	-2%

Demand as per 17<sup>th</sup> Electric Power Survey  
Source: Power Scenario at a Glance, January 2011, CEA

## STANDARDS FOR POWER FREQUENCY INDIA

As per the Indian Electricity Rules 1956 (amended up to 25th Nov 2000), the permissible range for grid frequency was +/- 3 % of nominal i.e. 48.5 Hz to 51.5 Hz. The permissible frequency ranges (by manufacturers) for operation of various makes of steam turbine are shown in Figure 1. The nominal frequency of operation in Indian grid is 50.0 Hz and the permissible frequency band specified by Indian Electricity Grid Code (IEGC) is 49.5 Hz to 50.2 Hz w.e.f 3rd May 2010.

S.NO.	TURBINE	FREQUENCY(HZ.)	TIME FOR OPERATION
1	100 MW, 200 MW, 210 MW of Russian Design	49.0 to 50.5	Continuous unrestricted operation
		50.5 to 51.0	3 minutes at a stretch and 500 minutes in whole life
		48.0 to 49.0	3 minutes at a stretch and 500 minutes in whole life
		47.0 to 48.0	1 minute at a stretch and 180 minutes in whole life
2	210 MW, 500 MW of KWU design	47.5 to 51.5	Continuous unrestricted operation
		Below 47.5	2 hours in whole life
		Above 51.5	2 hours in whole life
3	200 MW of CE (ANSALDO) design	48.5 to 50.5	Continuous unrestricted operation
		50.5 to 51.0	90 minutes in whole life
		40.0 to 40.5	90 minutes in whole life
		51.0 to 51.5	15 minutes in whole life
		47.5 to 48.0	15 minutes in whole life
		51.5 to 52.0	1 minute in whole life
4	RAPS/NAPS 2x220 MW English Electric	48.5-Operating Frequency >51.5	Summation in lifetime $t \leq 3$ minutes where 't' is the operating time for incidents of frequency excursion below 48.5 Hz. Not recommended
		49.0 - 51.0	Continuous unrestricted operation
		40.0 - 49.0	2 hours at a stretch and 30 hours in a year
5	110 MW of Skoda Design	47.0 - 48.0	30 minutes at a stretch and 2 hours in a year

Source : Extracts from the report of "Task Force on Frequency Control" NREB, 1992

## INITIATIVES OF CERC FOR IMPROVING FREQUENCY PROFILE IN THE GRID

Sale-purchase of electric energy in India is at the rates agreed in the respective contracts. These contracts are scheduled in the grid by the appropriate load despatch centres as per the requests of the sellers/buyers. However during actual operation the quantum of injection into the grid by the seller and/or the off-take from the grid by the buyers may deviate from agreed schedule. The quantum of deviation from schedule is known as Unscheduled Interchange (UI) that is settled at the pre-defined Unscheduled Interchange rate (UI vector) specified by the commission. The UI rate at a certain time is dependent on the frequency at that time. Thus the UI vector is linked to the frequency. CERC has taken several measures to improve the frequency profile in the grid by gradually tightening the permissible operating band for frequency and the volume of unscheduled Interchange by the entities in the grid.

The normal operating frequency range allowed by the Indian Electricity Grid Code till 31st March 2009 was 49.0 to 50.5 Hz. The frequency band was tightened by CERC in subsequent amendments to IEGC. The frequency band w.e.f 3rd May 2010 is 49.5 Hz to 50.2 Hz

**Table 3: Operating range for frequency specified in IEGC**

S No.	Period	Operating Range (In Hz)
1	Till 31 <sup>st</sup> March 2009	49.0 to 50.5
2	1 <sup>st</sup> April 2009 to 2 <sup>nd</sup> May 2010	49.2 to 50.3
3	w.e.f 3 <sup>rd</sup> May 2010	49.5 to 50.2

Similarly the UI mechanism has been revised several times in the past to improve the frequency profile in the grid. The various stages of evolution of the UI mechanism has been displayed as Annexure. The continuous improvement in the grid frequency profile is evident from the frequency profile recorded in the North-East-West grid in the past few years as displayed in figure 2 and 3 below.

the North-East-West grid in the past few years as displayed in figure 2 and 3 below.

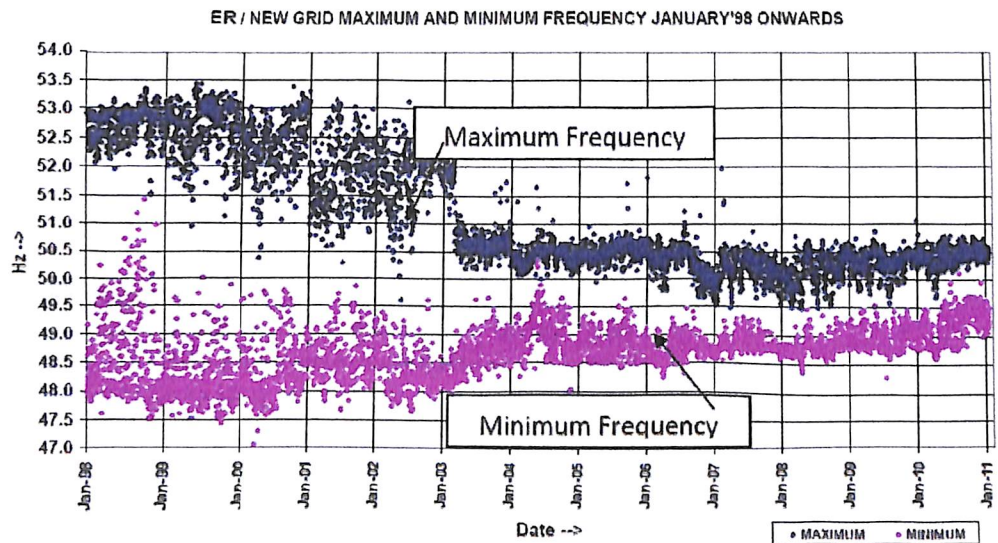

**Figure 1: Maximum and minimum frequency recorded in NEW grid**

SR GRID MAXIMUM, MINIMUM FREQUENCY PLOT FROM APRIL-2001 ONWARDS

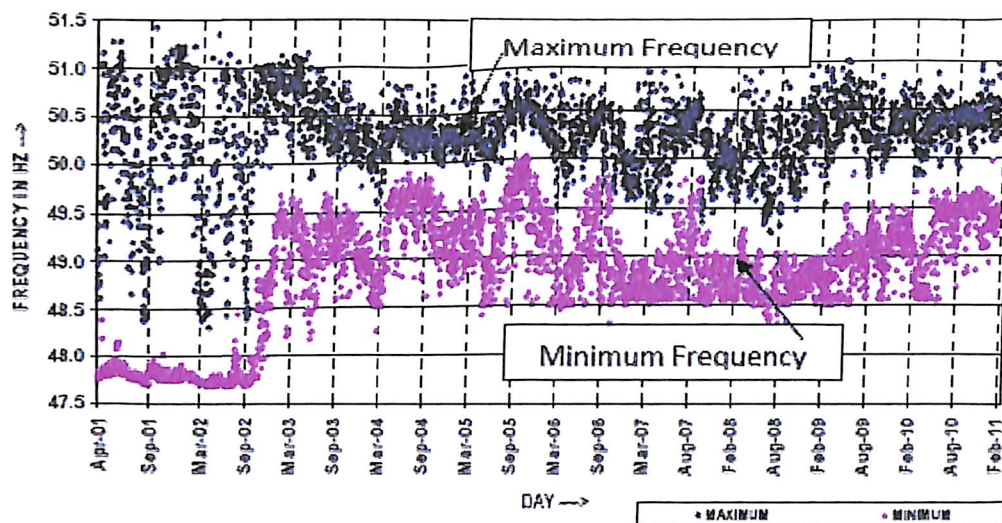

Figure 2: Maximum and Minimum frequency recorded in SR grid

## SIGNIFICANT DEVELOPMENTS AND CONCERNS IN INDIAN GRID

The power system in India is expanding at a fast pace to meet the requirements of Indian economy. Few significant developments in the power system that necessitate discussion on the frequency standards in the Indian grid have been highlighted below.

### Growing size of Interconnection

Indian grid is presently demarcated into five regional grids. Four out of the five grids (except Southern Grid) are operating in synchronism since August 2006. There are plans to integrate the Southern Grid with the rest of the grid through synchronous ties in near future (presently it is through asynchronous HVDC link). Indian grid is also striving to expand by establishing interconnection with neighboring countries. Bhutan is already synchronously interconnected while Nepal has several asynchronous ties with the Indian grid (AC radial links). A project for establishing asynchronous ties with Bangladesh through HVDC back-to-back link is already under progress. A Maximum Frequency

Minimum Frequency tighter operating band for frequency is essential for secure operation of a large synchronous interconnection.

The system is generally planned for outage of single largest unit outage. However number of incidents where the complete power station has tripped is also significantly high. In fact almost all large power stations in the country have gone under forced outage at least once. The grid frequency needs to be maintained at level so that the system is able to bear the impact of such large but credible contingencies, even if it is with the help of suitable protection schemes such as

load shedding schemes initiated by Under frequency, Rate of Change of frequency and Under Voltage. The setting of automatic load shedding through under frequency and rate of change of frequency relays is shown in Tables below

**Table 7: Under Frequency Relay settings adopted in India**

Region	Stage-I	Stage-II	Stage-III
Northern Region	48.8 Hz	48.6 Hz	48.2 Hz
Western Region	48.8 Hz	48.6 Hz	48.2 Hz
Eastern Region	48.5 Hz	48.2 Hz	48.0 Hz
North-eastern region	48.8 Hz	48.5 Hz	48.2 Hz
Southern Region	48.8 Hz	48.5Hz	48.2 Hz

**Table 8: Rate of Change of Frequency Relay setting adopted in Indian grid**

Region	Stage-I	Stage-II	Stage-III
NR	0.1 Hz per sec and 49.9 Hz	0.2 Hz per sec and 49.9 Hz	0.2 Hz per sec and 49.9 Hz
WR	0.1 Hz per sec and 49.9 Hz	0.2 Hz per sec and 49.9 Hz	
SR	0.3 Hz per sec and 49.5 Hz (Alarm)	0.3 Hz per sec and 49.3 Hz (Trip)	

- **Growing expectations of consumers**

A large interconnection caters to a diverse category of consumers. A narrow operating range for grid frequency significantly reduces wear and tear in electrical machines and thus increases their life. Moreover, with the increase in the proportion of sophisticated consumer loads such as process industries, traction locomotives and silicon loads the expectation of a better power quality from the grid is also rising.

- **Impact of frequency on voltage**

It has been observed from studies that increase in frequency results in increase in voltage and decrease in frequency results in decrease in voltage. In Northern grid it has been observed that

one Hz frequency increase/decrease is equivalent to 8 kV increase or decrease in voltage. This would have a significant impact on transmission losses and efficiency in the grid.

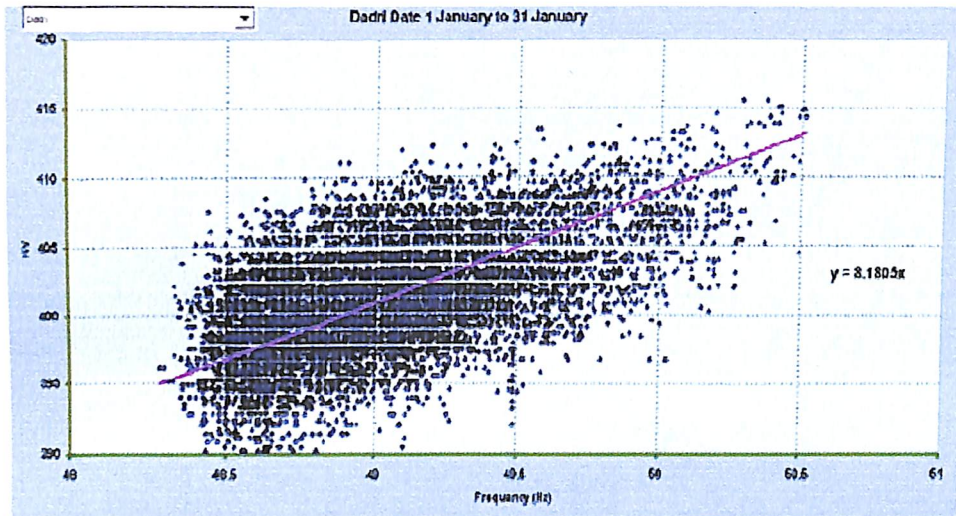

**Figure 3: Impact of grid frequency on grid voltage**

- **Frequency fluctuations and primary response from generators**

It has been observed that the power number in NEW grid and SR grid is 1800 MW per Hertz and 1020 MW per Hertz respectively. Tightening of frequency band by 0.1 Hz may imply reduction in demand met by approximately 180 MW in NEW Grid and approximately 102 MW in SR Grid. However, grid operation within a narrow range would encourage utilities to provide primary response from their generators. This would help in arresting the wide variations in frequency and network loadings during sudden change in injection/withdrawal from the grid. Thus improved security and efficiency gains obtained through tightening of frequency band are much larger.

- **Volume of unscheduled Interchange**

A frequency dependent unscheduled interchange mechanism is in place in the Indian grid. A wide operating range of frequency creates room for large volume of unscheduled interchanges. The volume of UI and the Scheduled Interchanges is shown in figure below

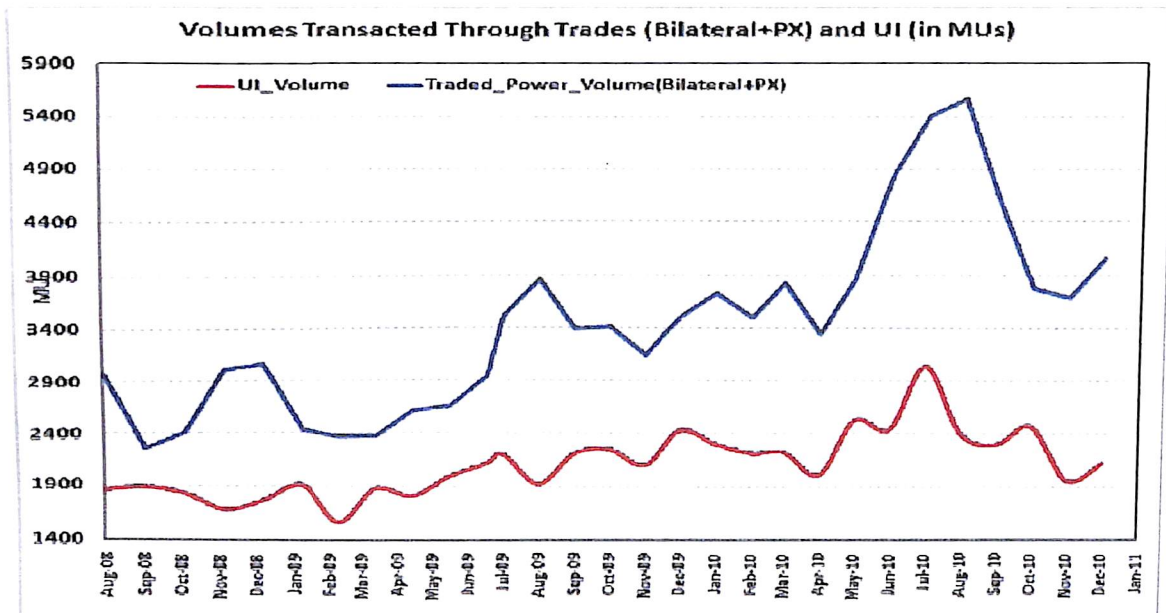

**Figure 4: Volume of Scheduled interchange and Unscheduled Interchange**

Several market players participate in the Indian market with a highly unbalanced portfolio. The unpredictability in the behavior of such market players has serious implications for grid security. Therefore CERC has taken several initiatives to encourage market players to shift from Unscheduled Interchange to Scheduled Interchange



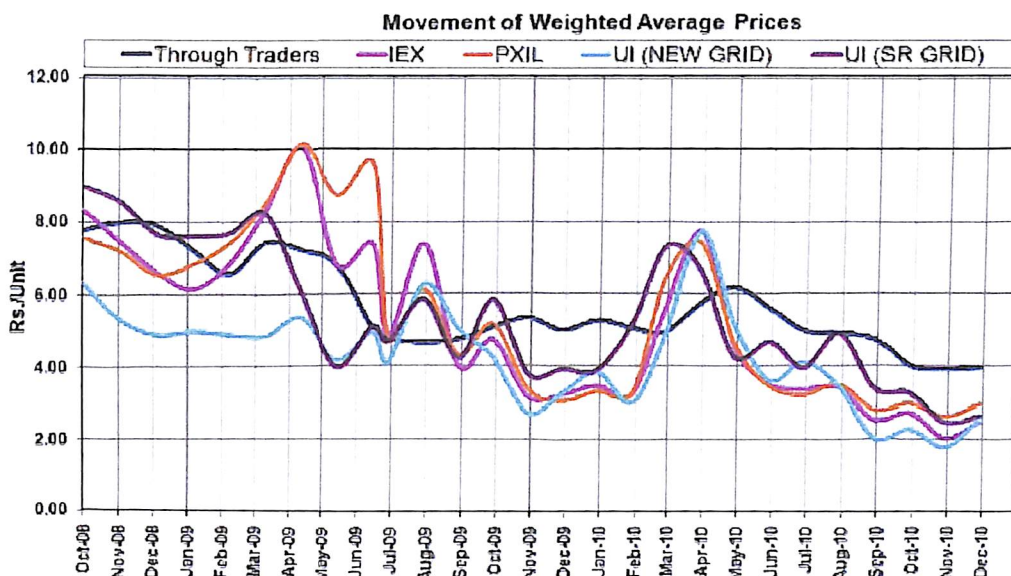

Figure 5: Trend of weighted Average Prices

A comparison of UI rate with the weighted average energy price in the bilateral and collective transactions in the NEW grid reveals that the UI rate has been lower than the negotiated price in bilateral transactions and the discovered price in the Power Exchange. This is a positive development and implies that buyers are willing to pay a premium for scheduled interchange that provides higher certainty. Therefore it is desirable to encourage the reliance on scheduled interchange through the available price signals and by enforcement of the UI volumes cap as mandated in the CERC regulations on Unscheduled Interchanges. The SERCs could also consider similar measures.

Integration of renewable energy in the grid is one of the biggest thrust areas. The contribution from wind energy is highest in the renewable portfolio. The installed wind generation capacity as on 30th Sep 2010 is 6070 MW. This is expected to be 13065 MW by Dec 2012. Considering the high variability and unpredictability of generation from renewable, the injection from wind energy can be safely absorbed in the grid only if the frequency in the grid is maintained in a comfortable range.

### COMPARISON OF PERMISSIBLE FREQUENCY IN OTHER COUNTRIES IN VIEW OF INDIA

It is evident from the previous sections that the wide range of permissible frequency by design has economic as well as security concerns in a large grid. In this context the permissible deviation from the nominal frequency prevailing in other countries has been examined and is shown in Table below

Table 9: Permissible Frequency band in other countries

Country/Interconnection	Nominal frequency (Hz)	Permissible Frequency Band (Hz)	Permissible Deviation (%)
Eastern Interconnection (US)	60	59.95 - 60.05	+/-0.083%
Nordic countries	50	49.9 - 50.1	+/- 0.2%
Western Interconnection (US)	60	59.856 to 60.144	+/-0.24 %
Europe	50	49.8 - 50.2	+/- 0.4 %
India	50	49.5 – 50.2	- 1 % / +0.4 %
Other SAARC countries	50	49.5 - 50.5	+/- 1%

The intent of CERC on the desirable frequency band as mentioned in CERC order on ABT dated 4th

January 2000

Quote

“5.9.8 Another point for consideration is whether charges for over drawal should be the same at 49.0 Hz and even below 49.0 Hz. It should be noted that the declared frequency in India is 50 Hz. An integrated power system should operate with a grid frequency hovering around 50 Hz. In practice however, the frequency range in India has been 48.5 Hz to 50.00 Hz. This is not desirable for achieving interconnected/integrated operation of the grid. With the additions to generation capacities, it is hoped that there may not be a drop below 49 Hz. .... In fact the attempt should be to further narrow down the range with more generating capacities coming up and redundancy created.”

Unquote

The issue also finds a mention in the Minutes of Meeting of 4th Coordination Forum held on 17th

August 2009

Quote

“...It was highlighted in the presentation that low frequency situations are also resulting in sub standard grid voltages. After the discussion, it was generally felt that there was a need to further narrow down the permissible frequency range from 49.5 Hz to 50.3 Hz w.e.f. January 2010 and from 49.8 Hz to 50.2 Hz w.e.f. January 2011....”

## **ISSUES FOR DISCUSSION WITH RESPECT TO TIGHTENING OF FREQUENCY BAND**

The issues that need to be discussed are as below:

a) Tightening of operating frequency band is desirable

What should be next operating range for frequency?

Presently the operating range is 49.5 to 50.2 Hz

Suggested solution by CERC staff

In year 2011: 49.7 to 50.2 Hz with a Step Size of 0.01 Hz

In year 2012: 49.8 to 50.1 Hz with a Step Size of 0.01 Hz

Deviations from schedule are inevitable and the deviations from schedule would be settled at the UI rate. What should be the permissible volume of Unscheduled Interchange for a control area as a percentage of its schedule?

## **OTHER ISSUES RELATED TO GRID SECURITY**

Power System visualization and situational awareness are vital for decision making at the control centre. This requires reliable and fast communication between the generating stations/substations and the control centre. With the rapid expansion in the power system infrastructure in India a robust communication infrastructure is also required for power system operation and control. The major issue in this regard is the urgent need for an exclusive Regulation on communication system for Power Sector

## **CERC (Deviation Settlement Mechanism and related matters) Regulations, 2014**

Replacement of existing UI Regulations which is effective since 17.09.12

Objective:

- Discourage deviation from Schedule
- Operate within the freq band
- Ensure grid security
- Operation of network elements within acceptable limits
- Operation of network elements within acceptable limits

Important Changes vis-à-vis Existing UI regulation:

- Buyer/Seller
- Rate vector:

SL No	EXISTING UI RATE
1	$f \geq 50.20\text{Hz}$ , RUI=0
2	$50.20 > f \geq 50.00$ , RUI increases by 16.5 p/u for each 0.02Hz step
3	$50.00 > f \geq 49.8$ , RUI increases by 28.50 p/u for each 0.02Hz step
4	$49.8 > f \geq 49.50$ , RUI increases by 28.12 p/u for each 0.02Hz step
5	$f < 49.5$ , RUI= 900 p/u

### Existing UI Rate (paise/unit)

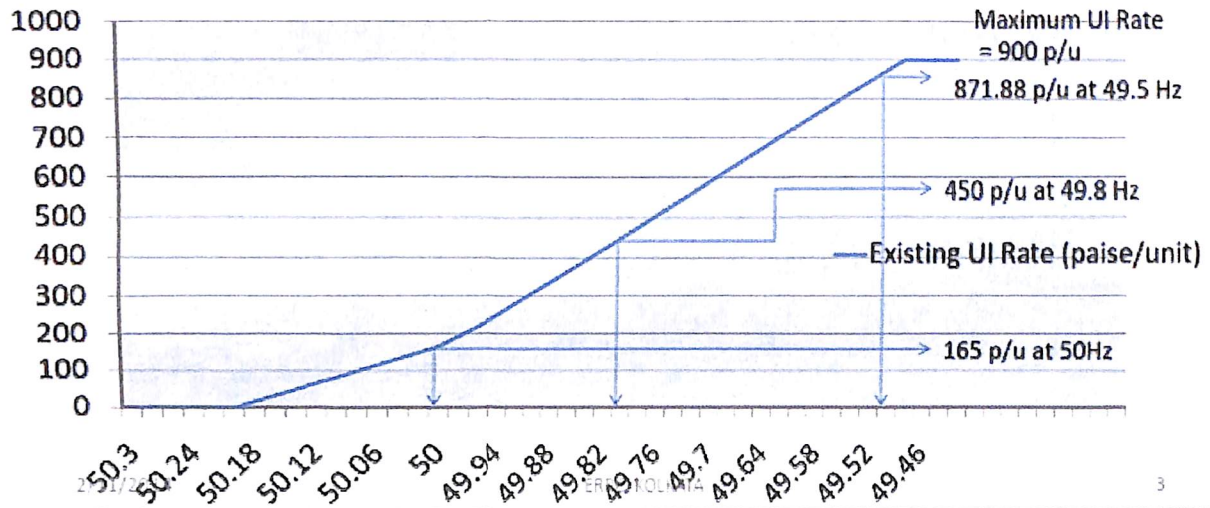

SL No	NEW RATE FOR DEVIATION CHARGE
1	$f \geq 50.05\text{Hz}$ , RDC=0
2	$50.05 > f \geq 50.00$ , RDC increases by 35.6 p/u for each 0.01Hz step
3	$50.00 > f \geq 49.7$ , RDC increases by 20.84 p/u for each 0.01Hz step
4	$f < 49.7$ , RDC=824.04p/u

**Rate for Deviation Charge ( paise/unit )**

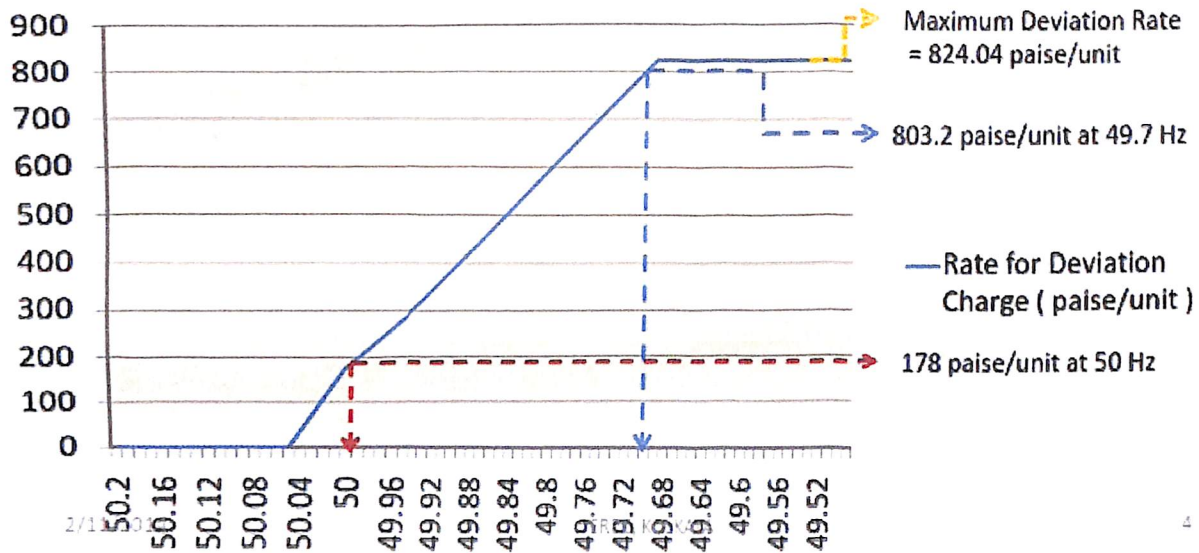

### BUYERS/SELLERS

Over injection/Under drawl :

- Charges for Deviation receivable for over injection/under drawl in a time block within the volume capping of 12% of Schedule or 150MW whichever is less in normal Deviation Charge depending on freq. whichever is less in normal Deviation Charge depending on freq.
- For any over injection/under drawl beyond the volume capping limit in a time block, the charges receivable is zero.
- Additional Charges for Deviation for over injection/under drawl in any time block when  $f \geq 50.10\text{Hz}$  at 178 p/u

Over drawl/Under injection:

- A. Charges for Deviation payable for over drawl/under injection in a time block in normal Deviation Charge depending on freq.

B. Additional charges for Deviation levied for over draw/under injection beyond the volume capping

limit as follows:

- Freq ---- 49.7 Hz and above
  - Freq ---- 49.7 Hz and above
- a. 12% of Schedule in a time block  $\leq$  150 MW

**a. 12% of Sch in a time block  $\leq$  150 MW**

Overdrawal/ Underinjection	12-15%	15-20%	Above 20%
Additional Charges for Deviation	20 % of Normal Deviation Charge depending on average freq of that block	40 % of Normal Deviation Charge depending on average freq of that block	100 % of Normal Deviation Charge depending on average freq of that block
2/11/2014	ERPC, KOLKATA		6

**b) 12% of Sch in a time block  $>$  150 MW**

Overdrawal/ Underinjection	150-200MW	200-250MW	Above 250MW
Additional Charges for Deviation	20 % of Normal Deviation Charge depending on average freq of that block	40 % of Normal Deviation Charge depending on average freq of that block	100 % of Normal Deviation Charge depending on average freq of that block

This is a new provision added to this regulation.

Freq ---- Below 49.7 Hz  
 Additonal Charges levied = 824.04 p/u  
 Total Charges = 1648.08 p/u

Buyer/Seller : Underdrawal/Overinjection:

	Sch	Act	Dev	Freq	Dev Rate	Min (12% of Col2,15 0)	Dev Charge Receivable	Quantum of Deviation for Addl Dev Charge	Additional Dev Charge Payable
1	1450	1480	30	49.9	407.24	150	30*407.24	0	0
2	1450	1680	230	50	178	150	150*178	0	0
3	1200	1380	180	49.96	261.36	144	144*261.36	0	0
4	1300	1350	50	50.12	0	150	0	50	50*178
5	-120	-100	20	49.9	407.24	14.4	14.4*407.24	0	0
6	-1300	-1210	90	50	178	150	90*178	0	0
7	-1300	-1140	160	49.96	261.36	150	150*261.36	0	0
8	-1150	-1010	140	49.84	511.44	138	138*511.44	0	0
9	-300	-240	60	50.18	0	36	0	60	60*178

2/11/2014 ERPC, KOLKATA 8

Buyer/Seller: Overdrawal/Underinjection:

	Sch	Act	Dev	Freq	Dev Rate	Min (12% of Col2, 150)	Dev Charge Payable	Quantum of Deviation for Addl Dev Charge	Additional Dev Charge Payable
1	1450	1420	-30	49.9	407.24	150	30*407.24	0	0
2	1450	1190	-260	49.8	594.8	150	260*594.8	110	50*0.2*594.8+50*0.4*594.8+10*594.8
3	1180	940	-240	49.75	678.16	141.6	240*678.16	98.4	35.4*0.2*678.16+59*0.4*678.16+4*678.16
4	1180	1150	-30	49.68	824.04	141.6	30*824.04	30	30*824.04
5	-400	-435	-35	50.01	142.40	48	35*142.4	0	0
6	-400	-485	-85	49.86	469.76	48	85*469.76	37	12*0.2*469.76+20*0.4*469.76+5*469.76
7	-1400	-1665	-265	49.91	365.56	150	265*365.56	115	50*0.2*365.56+50*0.4*365.56+15*365.56
8	-250	-282	-32	49.61	824.04	30	32*824.04	32	32*824.04

2/11/2014 ERPC, KOLKATA 9

In a time block: Sch injection = 1450MW Act injection= 1190MW  
 Deviation = 1190-1450 = -260MW  
 Freq = 49.8 Hz, Dev Rate = 594.80 paisa/unit  
 Min ( 12% of Sch=174MW, 150MW) = 150MW  
 Total underinj allowed without levy of Addl Charge for Deviation = 150MW  
 Quantum of Underinjection on which Addl Charges for Deviation to be levied = 260-150 = 110 MW

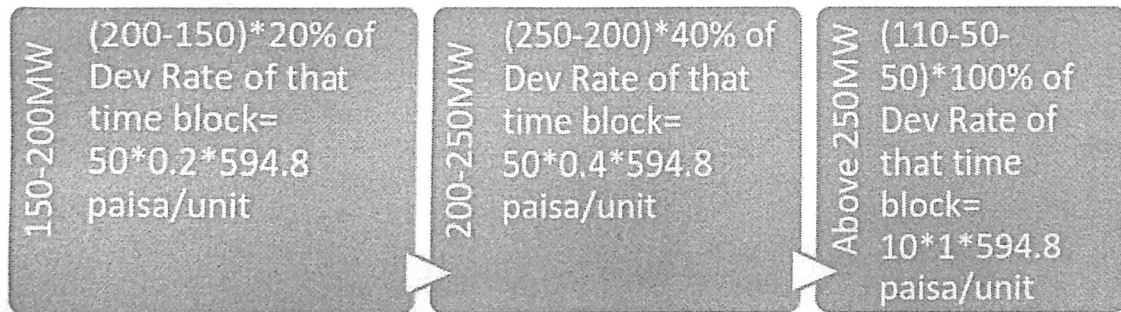

In a time block: Sch Drawal = -400MW Act Drawal= -485MW  
 Deviation = -485-(-400)= -85MW  
 Freq = 49.86 Hz, Dev Rate = 469.76 paisa/unit  
 Min ( 12% of Sch=48MW, 150MW) = 48MW  
 Total overdrawal allowed without levy of Addl Charge for Deviation = 48MW  
 Quantum of Overdrawal on which Addl Charges for Deviation to be levied = 85-48 = 37 MW

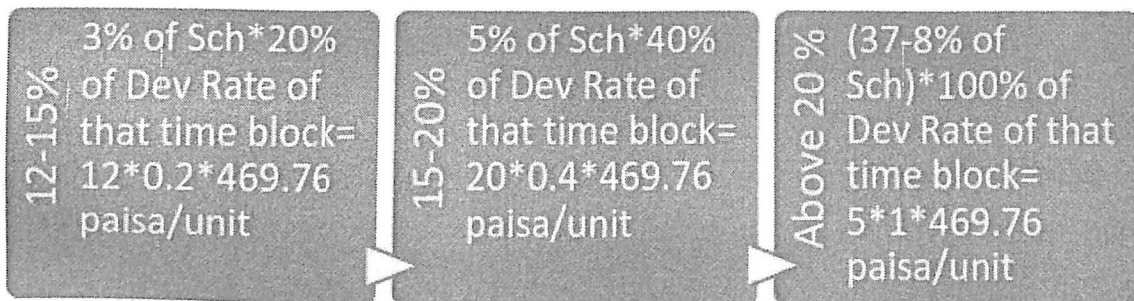



- Thermal Stations regulated by CERC and using coal under APM as fuel):

Existing UI Rate (paise/unit)

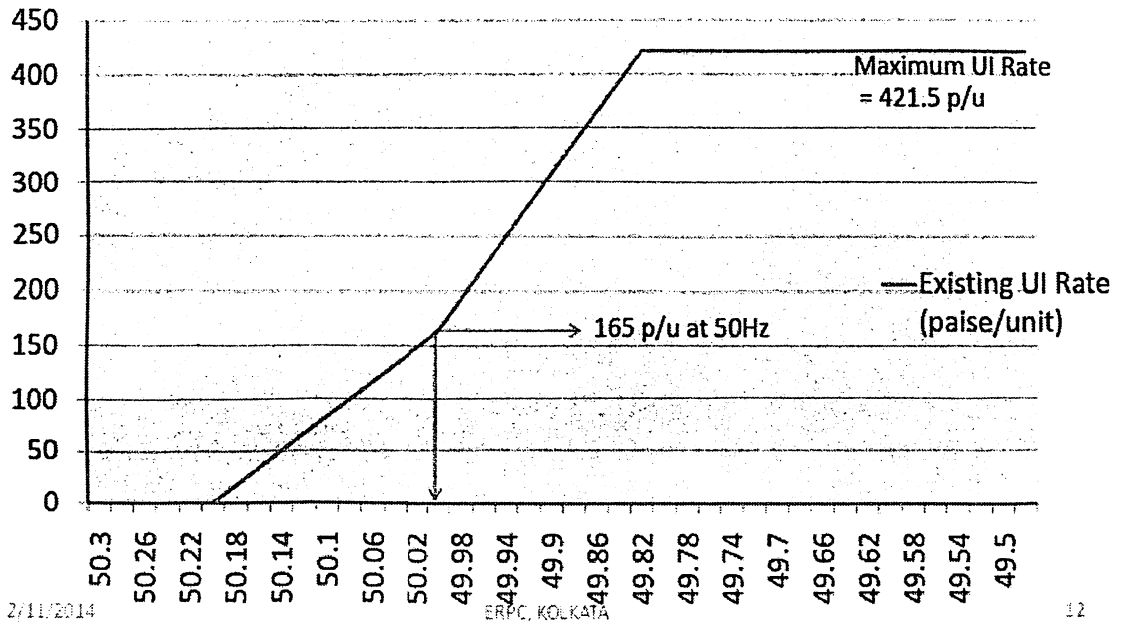

27/11/2014

ERPC, KOLKATA

12

- Thermal Stations regulated by CERC and using coal under APM as fuel:

**Rate for Deviation Charge ( paise/unit )**

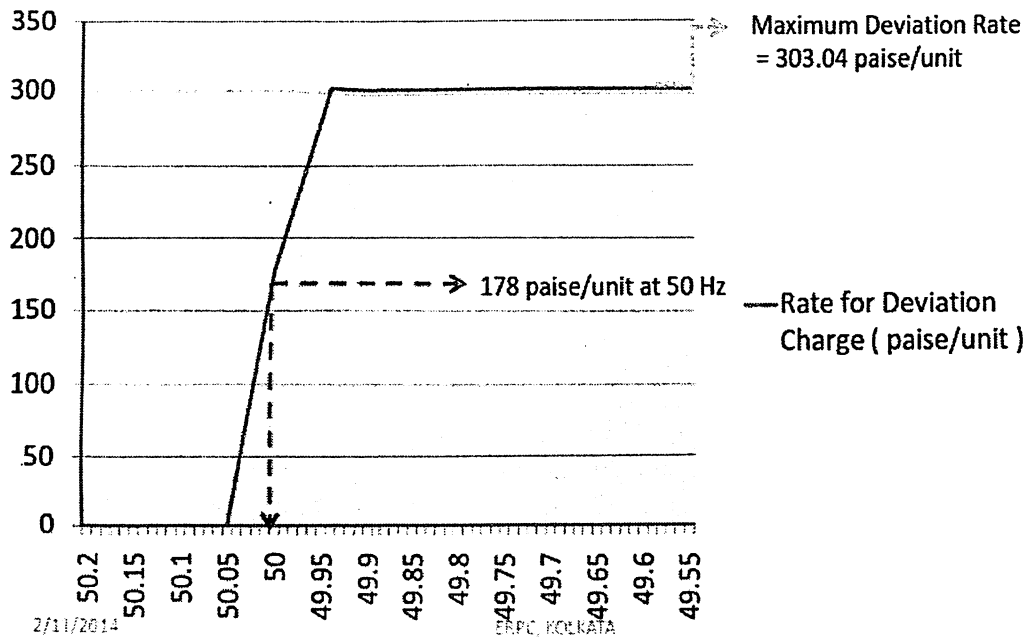

## Chapter 3

### **RESEARCH DESIGN, METHODOLOGY AND PLAN**

A methodology based on frequency linked tariff has been formulated which will be helpful in optimization of unscheduled interchange payment earning by the generators, market participants in deregulated power sector. Proper handling of unscheduled interchanges in a classical power system has been extended and developed a solution methodology clearly depicting how to improve these unscheduled interchange earning not only contributing to the station earning but at the same time contribute to help the grid to maintain grid discipline, which is ultimate aim of the Grid to incorporate the UI scheme in a deregulated power market. This new balancing mechanism is similar to a tariff scheme working successfully in India since 2002 and is based on block average frequency signals derived from frequency. The generators and loads under this framework can self-correct themselves based on real-time frequency signals and block average frequency, maximizing their benefit. This scheme does not require any additional control and communication infrastructure as price is communicated by means of frequency that can be sensed anywhere in the grid. Penalty imposed can also get reduced by controlling the severity of deviation.

The Proposed Technique involves the following steps:-

#### 3.1 Calculation of Block Avg Frequency: -

Considering the fact that for calculation of UI charges the frequency considered are of average of a block and the block are of 15 min duration. Hence calculation of the accurate time ie matching of the ABT time with the time of the system is an important aspect of the study. Further to this the exact calculation of the avg frequency with should be as close as possible with the avg frequency calculated by the ABT.

Often it has been seen the value of the frequency measured and available in the DCS are of less accuracy as a result the deviation is also high which becomes one of the limitation of the said system.

For enhancing the accuracy of the block avg frequency calculation an in house logic calculation has been done from the Turbine RPM, which gives an accuracy of 0.1 % which is quite suitable for the project undertaken.

Block diagram of the logic and calculation has been shown as follows:

- Instantaneous Frequency has been calculated from the Turbine Speed Measurement. As the number of measurement available six in number, the average of all six enhance the reliability and accuracy of the measurement.
- Further the samples are being averaged after an interval of 5 Sec ie 180 samples in a block to calculate the average block frequency.

Experience shows that this calculated average value is quite close to the ABT avg value which is one of the most desirable aspect of the study.

### INSTANTANEOUS FREQUENCY CALCULATION

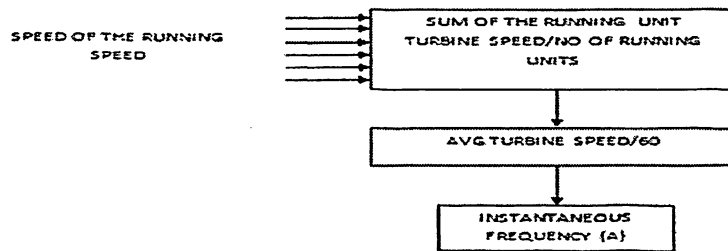

### AVERAGE BLOCK FREQUENCY CALCULATION

$$\text{AVG BLOCK FREQ (F}_{\text{avg}}) = F/N$$

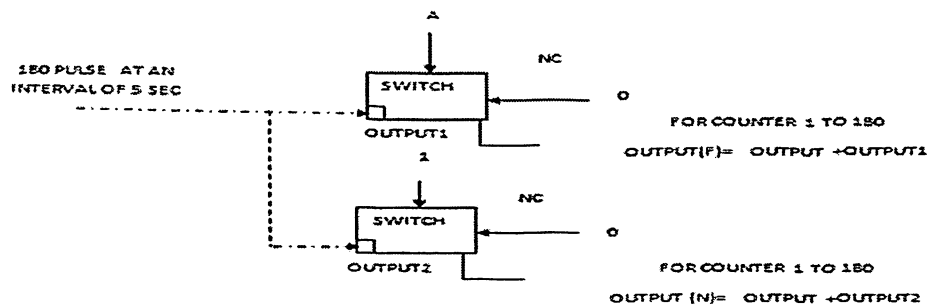

### 3.2 Auto Load Set Point Correction as per Unit Capability:-

Reference to the trailing block diagram, the block average frequency calculated as above are being feed as an input to a PID controller where the existing avg frequency are compared with the threshold frequency of (50.04 Hz). Based on the deviation the controller generates an output which is then compared to the Unit High and Low Limit and if it permits the correction are being added or subtracted to the operator given set point.

Once the correction are being done the Load controller acts with a pre defined RAMP and achieve the corrected load set point.

Considering the limitation of the correction based of the Unit Capability, coal and other plant limitation operator can very well select the limit of correction that can be applied on both Higher Side and Lower Side. For example if operator opts for a correction of +/- 5MW then when the Block Avg Frequency will be less than threshold frequency a max correction of +5 MW will get added to the operator entered SP and vice versa.

There are other plant related fine tuning can be done to stabilize the correction.

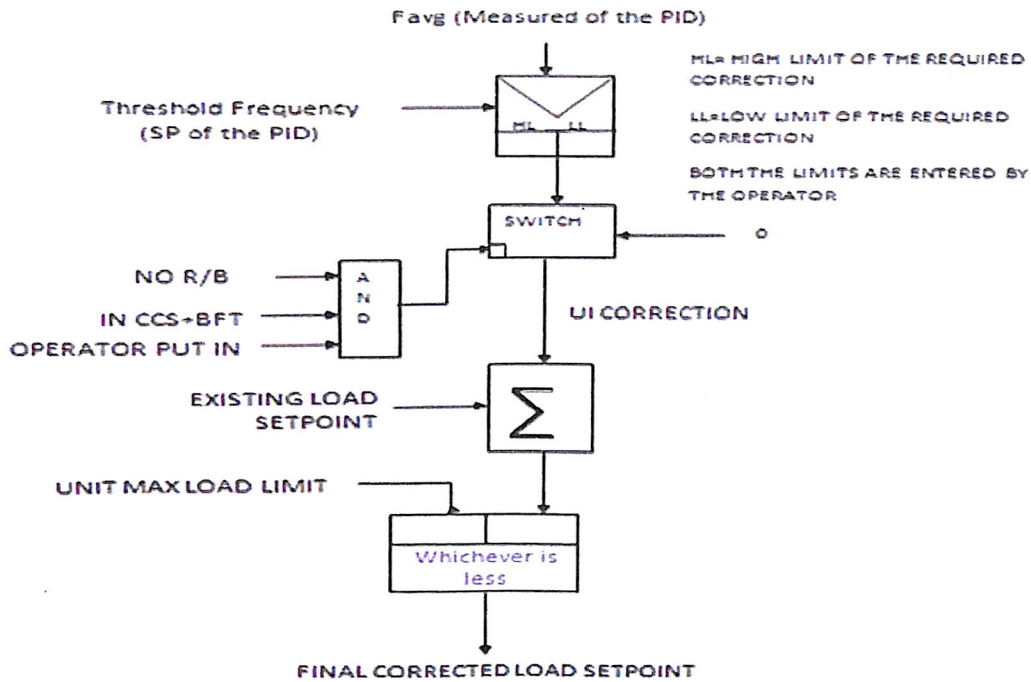

A properly configured and applied system when compared with a Unit where the system is yet to be applied can very well shows the difference.

### UNIT WITH UI CORRECTION

Time	OP_SP	UI_CORRECTION	INST_FREQ	AVG_FREQ	ACT_LOAD
01/08/2015 05:45:00	660.00	4.66	50.05	50.00	665.27
01/08/2015 05:50:00	660.00	4.98	50.05	50.00	665.17
01/08/2015 05:55:00	660.00	4.98	50.05	50.00	665.10
01/08/2015 06:00:00	660.00	-0.66	50.05	50.05	660.97
01/08/2015 06:05:00	660.00	-4.98	50.05	50.10	655.01
01/08/2015 06:10:00	660.00	-4.62	50.00	50.10	654.72
01/08/2015 06:15:00	662.51	1.76	49.95	50.00	659.62

### UNIT WITHOUT UI CORRECTION

01/08/2015 05:45:00	670.00	0.00	50.05	50.00	669.67
01/08/2015 05:50:00	670.00	0.00	50.05	50.00	670.16
01/08/2015 05:55:00	670.00	0.00	50.05	50.00	670.38
01/08/2015 06:00:00	670.00	0.00	50.05	50.05	670.32
01/08/2015 06:05:00	670.00	0.00	50.05	50.10	669.93
01/08/2015 06:10:00	670.00	0.00	50.00	50.10	669.76
01/08/2015 06:15:00	670.00	0.00	49.95	50.00	669.91

•TWO BLOCK DATA CONSIDERED FOR COMPARISOPN

As is clear for the above table that the Unit with UI has given a correction of +4.98 MW when the Block Avg Frequency was less than threshold frequency ie 50.04Hz and a correction of - 4.98MW when the Block Avg Frequency was higher than threshold frequency i.e. 50.04Hz i.e. the load varies from 655MW to 665MW when the load set point of the operator was 660MW only.

While on the other side for the same Block the load remains constant at 670MW ie operator set point even the block avg frequency varied in both the direction.

### 3.3 Determination of Profit/ Loss with respect to other similar Unit:-

As far as the profit and loss is concerned each extra MW generated from the scheduled demand particularly when the Block Avg Frequency in below the threshold frequency giving a raise in the earning and each MW reduced when frequency is at higher side is reducing my loss so ultimately in both the cases the generating unit is increasing the profit.

On the other hand it can be very clearly demonstrated that if the methodology can be implemented in all the units connected to grid then the ultimate gainer will be the grid whose frequency band will be always within the limit ie and improved quality of the supplied power.

For calculation of the Profit and Loss for the similar kind of the unit

Frequency of the grid is a function of supply-demand imbalance and not in control of one particular market participant. The profit (loss) to any electricity market participants is the difference of total revenue received and the cost of power purchase or generation cost in real time market. Therefore Profit/Loss in UI mechanism at any load or generator bus can be defined as a function of deviation of power. =  $(P_{act} - P_{sch})$  where is the deviation of power from the schedule in MW and is calculated by subtracting declared schedule from the actual drawal for each 15 minutes time block.

### 3.4 Other Variables

Some of the variables which are very important for successful execution of the claimed system and some of those with their impact has been detailed as follows:

- Time Cycle:

ABT Block time should exactly match the system time, preferably if the system time is synchronized with the GPRS time it will be most suitable.

Effect of variation of time is quite important ie as the UI Rates depend upon the Block Avg frequency and not on the Instantaneous frequency, many of time it has been seen that there is quite a high deviation in both of them and a wrong time can very well calculate the avg frequency wrongly which will ultimately cause an unwanted correction of load setpoint causing a ultimate loss not only in one block but for the each block.

- Instantaneous Frequency Measurement:

Block average frequency is being calculated by averaging out the instantaneous frequency it is very important and to have an accurate measurement of the same. Normally in most of the plant the frequency available in DCS are from the electrical transducer which are in monitoring class ie the accuracy levels are quite low ie may not be suitable for this type of application. Hence it is preferable to have a higher accuracy measurement or if at all it is not available it should be calculated from the Turbine Speed which will be always a better option to have.

Being the main input which is being feed to the controller and is compared to get the desired correction, any error in measurement will result a wrong correction and an ultimate loss.

- Plant and Process Limitation:

One of the key concerns while implementing the claimed system is the process limitation ie the Load Controller and related important controller should be able to take the variations of the set point that is being corrected by the modification, many of time during the starting of the Block the frequency varies quite fast so either the unit should be capable enough to control the variation or the same should be implemented with different correction.

Failing to achieve the same it will be very difficult to maintain the process parameter within the limit and may further impact the generation or instability.

Operator must give the max correction limit in both the direction by seeing the coal and other parameters which can be achieved by the unit. The logic should be designed in such a way that it should not cross that limit and further it should not cross the Max Load Limit as well.

The Plant Controller Mode shall be properly selected to achieve max benefit of the claimed system. Boiler Follow Turbine is the optimum best suitable for the said system.

Sufficient precaution shall be logically taken to quit out the system during emergency of the plant, so that a safe option can selected and achieved.

A three day report on Block wise has been prepared and compared with the same capacity of the unit without having the UI Correction Logic Modification.

The Duration Considered is taken same, so that a comparison can be studied.

**UNIT WITH UI CORRECTION**

Date	Time	Operator Set Point	UI Correction	Block Avg Frequency	Instantaneous Frequency	Corrected MW
01/08/2015	04:40:00	660	4.99	50	50	664.68
01/08/2015	04:35:00	660	4.99	50.05	50	664.91
01/08/2015	04:30:00	662.49	4.99	50.05	50	667.78
01/08/2015	04:25:00	665	4.99	50.05	50	670.04
01/08/2015	04:20:00	665	4.99	50.05	50	670.07
01/08/2015	04:15:00	665	2.62	50.05	50	666.27
01/08/2015	04:10:00	665	-0.58	50.05	50	664.74
01/08/2015	04:05:00	665	0	50.05	50	665.16
01/08/2015	04:00:00	665	1.64	50.05	50	667.74
01/08/2015	03:55:00	665	3.22	50.05	50	668.58
01/08/2015	03:50:00	665	4.41	50.05	50	669.55
01/08/2015	03:45:00	665	4.85	50	50	669.99
01/08/2015	03:40:00	665	5	49.95	50	670.33
01/08/2015	03:35:00	665	5	49.95	50	669.85
01/08/2015	03:30:00	665	5	49.95	50	669.75
01/08/2015	03:25:00	665	5	49.95	50	670.23
01/08/2015	03:20:00	665	5	49.95	50	670.32
01/08/2015	03:15:00	665	5	49.95	50	669.89
01/08/2015	03:10:00	665	3.29	49.95	50	667.78
01/08/2015	03:05:00	665	0.38	50	50	665.52
01/08/2015	03:00:00	665	2.21	50.05	50	667.42
01/08/2015	02:55:00	665	4.92	50.05	50	669.64
01/08/2015	02:50:00	665	4.92	50	50	669.6
01/08/2015	02:45:00	665	4.92	49.95	50	670.47
01/08/2015	02:40:00	665	4.92	50	50	670.62
01/08/2015	02:35:00	665	4.92	50.05	50	669.58
01/08/2015	02:30:00	665	4.92	50	49.93	669.59
01/08/2015	02:25:00	665	4.92	49.9	49.86	670.23
01/08/2015	02:20:00	665	4.92	49.85	49.86	670.53
01/08/2015	02:15:00	665	4.92	49.9	49.91	669.31
01/08/2015	02:10:00	665	4.92	49.96	49.96	669.23
01/08/2015	02:05:00	665	4.87	50.01	49.96	669.73
01/08/2015	02:00:00	665	4.57	50.06	49.96	669.73



01/08/2015	01:55:00	665	4.96	50	49.91	670.28
01/08/2015	01:50:00	665	4.96	49.95	49.86	669.74
01/08/2015	01:45:00	665	4.04	49.9	49.93	667.24
01/08/2015	01:40:00	665	0.96	49.96	49.99	666.27
01/08/2015	01:35:00	665	0.96	50.01	49.99	665.9
01/08/2015	01:30:00	665	0.96	49.96	49.99	665.82
01/08/2015	01:25:00	665	0.96	49.96	49.99	666.39
01/08/2015	01:20:00	665	0.96	49.96	49.99	666.34
01/08/2015	01:15:00	665	0.96	49.96	49.99	665.88
01/08/2015	01:10:00	665	0.96	49.96	49.99	666.41
01/08/2015	01:05:00	665	0.96	49.96	49.99	666.03
01/08/2015	01:00:00	665	0.96	49.96	49.99	666.07
01/08/2015	00:55:00	665	0.96	49.96	49.99	665.97
01/08/2015	00:50:00	665	0.96	49.96	49.99	665.84
01/08/2015	00:45:00	665	0.96	49.96	49.99	666.14
01/08/2015	00:40:00	665	0.96	49.96	49.99	666.08
01/08/2015	00:35:00	665	0.96	49.96	49.99	665.87
01/08/2015	00:30:00	665	0.85	49.96	49.99	665.78
01/08/2015	00:25:00	665	0.95	49.96	49.99	665.98
01/08/2015	00:20:00	665	0.95	49.96	49.99	666.02
01/08/2015	00:15:00	665	0.95	49.96	49.99	666.14
01/08/2015	00:10:00	665	0.95	49.96	49.99	666.02
01/08/2015	00:05:00	665	-1.75	49.96	50.04	663.04
01/08/2015	00:00:00	665	-4.76	50.01	50.09	660.04
01/08/2015	11:20:00	665	4.96	49.95	49.9	669.92
01/08/2015	11:15:00	665	4.96	49.95	49.95	669.85
01/08/2015	11:10:00	665	4.96	49.95	50.01	669.82
01/08/2015	11:05:00	665	4.96	49.95	50.01	670.29
01/08/2015	11:00:00	665	4.96	49.95	50.01	669.97
01/08/2015	10:55:00	665	4.96	49.95	50.01	669.82
01/08/2015	10:50:00	665	4.96	49.95	50.01	669.87
01/08/2015	10:45:00	665	4.96	49.95	50.01	669.82
01/08/2015	10:40:00	665	4.96	49.95	50.01	669.88
01/08/2015	10:35:00	665	4.96	49.95	50.01	669.9
01/08/2015	10:30:00	665	4.96	49.95	50.01	669.76
01/08/2015	10:25:00	665	4.96	49.95	50.01	669.39
01/08/2015	10:20:00	662.68	4.96	49.95	50.01	668.73
01/08/2015	10:15:00	660.17	3.83	49.95	50.01	663.73
01/08/2015	10:10:00	660	-0.44	49.95	50.01	657.17
01/08/2015	10:05:00	660.3	-4.44	50	50.01	656.56
01/08/2015	10:00:00	662.81	-0.06	50.05	50.01	666.69
01/08/2015	09:55:00	665	4.99	50	50.01	670.44

01/08/2015	09:50:00	665	4.99	49.95	50.01	669.48
01/08/2015	09:45:00	665	4.99	49.95	49.96	669.52
01/08/2015	09:40:00	665	4.99	49.95	49.91	670.47
01/08/2015	09:35:00	665	4.99	49.95	49.91	670.53
01/08/2015	09:30:00	665	4.99	49.95	49.96	668.88
01/08/2015	09:25:00	662.5	4.99	50	49.96	665.4
01/08/2015	09:20:00	661.54	4.99	50.05	49.91	667.31
01/08/2015	09:15:00	662.93	2.42	50	49.97	661.85
01/08/2015	09:10:00	657.51	-3.61	50	50.03	651.34
01/08/2015	09:05:00	655.08	-1.98	50.05	50.03	655
01/08/2015	09:00:00	657.58	3.05	50.05	50.03	662.42
01/08/2015	08:55:00	662.14	4.89	50.05	50.03	667.58
01/08/2015	08:50:00	664.65	4.94	50.05	50.03	670.32
01/08/2015	08:45:00	665	4.94	50.05	50.03	670.23
01/08/2015	08:40:00	665	4.94	50.05	50.03	669.61
01/08/2015	08:35:00	665	4.94	50.05	50.03	669.61
01/08/2015	08:30:00	665	4.56	50	50.03	670.19
01/08/2015	08:25:00	665	4.93	49.95	50.03	670.54
01/08/2015	08:20:00	665	4.93	49.95	50.03	670.72
01/08/2015	08:15:00	665	3.79	49.95	50.03	667.57
01/08/2015	08:10:00	665	-1.34	50	50.03	661.31
01/08/2015	08:05:00	665	-4.92	50.06	50.03	660.45
01/08/2015	08:00:00	665	-4.76	50.06	50.03	659.6
01/08/2015	07:55:00	665	-4.89	50.06	50.03	660.63
01/08/2015	07:50:00	665	-0.91	50.06	50.03	665.92
01/08/2015	07:45:00	665	4.2	50.06	49.98	669.32
01/08/2015	07:40:00	665	4.94	50.01	49.93	670.02
01/08/2015	07:35:00	665	4.94	49.95	49.93	669.85
01/08/2015	07:30:00	665	4.69	49.95	49.93	669.91
01/08/2015	07:25:00	665	4.66	49.95	49.93	669.91
01/08/2015	07:20:00	665	3.44	49.95	49.93	667.31
01/08/2015	07:15:00	665	1	50.01	49.93	665.92
01/08/2015	07:10:00	665	1	50.06	49.93	665.98
01/08/2015	07:05:00	665	1	50	49.93	665.87
01/08/2015	07:00:00	665	1	49.95	49.98	665.68
01/08/2015	06:55:00	665	1	49.95	50.04	666.19
01/08/2015	06:50:00	665	2.98	49.95	50.04	668.81
01/08/2015	06:45:00	665	4.95	49.95	50.04	670
01/08/2015	06:40:00	665	4.95	49.95	50.04	669.96
01/08/2015	06:35:00	665	4.69	49.95	50.04	670.08
01/08/2015	06:30:00	665	3.82	50	49.97	669.87

01/08/2015	06:25:00	665	4.99	50.06	49.89	670.78
01/08/2015	06:20:00	665	4.99	50	49.89	669.36
01/08/2015	06:15:00	662.51	1.76	49.95	50	659.62
01/08/2015	06:10:00	660	-4.62	50	50.1	654.72
01/08/2015	06:05:00	660	-4.98	50.05	50.1	655.01
01/08/2015	06:00:00	660	-0.66	50.05	50.05	660.97
01/08/2015	05:55:00	660	4.98	50.05	50	665.1
01/08/2015	05:50:00	660	4.98	50.05	50	665.17
01/08/2015	05:45:00	660	4.66	50.05	50	665.27
01/08/2015	05:40:00	660	4.92	50.05	50	665.08
01/08/2015	05:35:00	660	3.45	50.05	50	662.38
01/08/2015	05:30:00	660	2.85	50.05	50	662.49
01/08/2015	05:25:00	660	4.97	50.05	50	666.36
01/08/2015	05:20:00	660	4.97	50.05	50	663.32
01/08/2015	05:15:00	655.2	0.68	50.05	50	651.74
01/08/2015	05:10:00	650.49	-4.91	50.05	50	646.76
01/08/2015	05:05:00	655.6	-2.35	50.05	50	656.47
01/08/2015	05:00:00	660	2.59	50.05	50	663.62
01/08/2015	04:55:00	660	4.99	50.05	50	664.55
01/08/2015	04:50:00	660	4.99	50	50	665.28
01/08/2015	04:45:00	660	4.99	49.95	50	665.27
01/08/2015	18:00:00	625	-1.99	50.1	50.07	623.34
01/08/2015	17:55:00	625	-1.99	50.05	50.02	622.72
01/08/2015	17:50:00	625	-1.99	50.05	50.02	623.04
01/08/2015	17:45:00	625	-1.81	50.05	50.02	622.74
01/08/2015	17:40:00	625	-1.93	50.05	50.02	623.09
01/08/2015	17:35:00	625	-1.29	50.05	50.02	624.75
01/08/2015	17:30:00	622.36	0.57	50.05	50.07	621.95
01/08/2015	17:25:00	617.33	-0.05	50.05	50.13	615.08
01/08/2015	17:20:00	610.55	-0.13	50.05	50.13	608.21
01/08/2015	17:15:00	609.57	-0.46	50.05	50.13	609.2
01/08/2015	17:10:00	617.68	-1.97	50.1	50.13	617.41
01/08/2015	17:05:00	627.69	-1.97	50.15	50.08	628.37
01/08/2015	17:00:00	635	-0.24	50.1	50.02	634.69
01/08/2015	16:55:00	635	1.97	50.05	50.02	637.69
01/08/2015	16:50:00	635	1.97	50.05	50.02	636.99
01/08/2015	16:45:00	635	1.97	50.05	50.02	636.9
01/08/2015	16:40:00	635	1.97	50.05	50.02	636.76
01/08/2015	16:35:00	635	1.97	50.05	50.02	636.08
01/08/2015	16:30:00	635	1.97	50.05	50.02	637.74
01/08/2015	16:25:00	635	1.97	50.05	50.02	638.2

01/08/2015	16:20:00	633.58	1.97	50.05	50.02	632.91
01/08/2015	16:15:00	628.55	0.82	50.05	50.02	625.27
01/08/2015	16:10:00	626.43	-1.94	50.05	50.02	625.86
01/08/2015	16:05:00	635.2	-1.94	50.05	50.02	637.65
01/08/2015	16:00:00	643.76	0.01	50.05	49.97	646.03
01/08/2015	15:55:00	645	1.91	50.05	49.92	648.21
01/08/2015	15:50:00	645	1.91	50	49.92	647.1
01/08/2015	15:45:00	640	1.91	49.95	49.98	639.28
01/08/2015	15:40:00	636.84	1.91	49.95	50.03	639.63
01/08/2015	15:35:00	646.23	1.91	49.95	50.03	650.16
01/08/2015	15:30:00	659.35	1.91	49.95	50.03	664.81
01/08/2015	15:25:00	665	1.91	49.95	50.03	668.01
01/08/2015	15:20:00	661.92	0.24	49.95	50.03	659.31
01/08/2015	15:15:00	656.91	-1.62	50	50.03	652.37
01/08/2015	15:10:00	657.08	-2	50.1	50.03	656.96
01/08/2015	15:05:00	662.11	-1.05	50.1	50.03	664.53
01/08/2015	15:00:00	665	1.01	50	49.98	666.57
01/08/2015	14:55:00	665	2	49.95	49.92	666.57
01/08/2015	14:50:00	665	2	49.95	49.92	666.81
01/08/2015	14:45:00	665	2	49.95	49.92	666.75
01/08/2015	14:40:00	665	2	49.95	49.92	667.21
01/08/2015	14:35:00	665	2	50	49.92	666.58
01/08/2015	14:30:00	665	2	50.05	49.92	665.58
01/08/2015	14:25:00	665	2	50.05	49.92	668.68
01/08/2015	14:20:00	665	3.45	50	49.92	670.65
01/08/2015	14:15:00	664.57	1.56	49.95	49.98	662.37
01/08/2015	14:10:00	661.04	-4.3	50	50.03	654.01
01/08/2015	14:05:00	661.1	-2.07	50.05	50.03	660.26
01/08/2015	14:00:00	664.61	2.94	50	49.98	668.97
01/08/2015	13:55:00	665	5	49.95	49.93	669.79
01/08/2015	13:50:00	665	5	49.95	49.93	666.67
01/08/2015	13:45:00	661.4	2.51	49.95	49.98	659.65
01/08/2015	13:40:00	652.87	-3.1	50	50.04	648.97
01/08/2015	13:35:00	644.02	-3.32	50.05	50.04	644.52
01/08/2015	13:30:00	645	-3.58	50.05	50.09	645.47
01/08/2015	13:25:00	640.02	-5	50.05	50.14	638.83
01/08/2015	13:20:00	635	-5	50.05	50.14	635.85
01/08/2015	13:15:00	635	-5	50.1	50.14	635.02
01/08/2015	13:10:00	635	-5	50.15	50.14	634.99
01/08/2015	13:05:00	636.64	-5	50.15	50.14	638.12
01/08/2015	13:00:00	644.13	-4.21	50.1	50.09	647.95

01/08/2015	12:55:00	654.49	-0.87	50.05	50.04	655.63
01/08/2015	12:50:00	658.1	2.25	50.05	50.04	661.67
01/08/2015	12:45:00	660	1.16	50	50.04	659.51
01/08/2015	12:40:00	660	-2.16	50	50.04	656.74
01/08/2015	12:35:00	660	-0.64	50.05	50.04	660.3
01/08/2015	12:30:00	662.5	3.17	50.05	50.04	666.81
01/08/2015	12:25:00	665	4.47	50	50.04	669.05
01/08/2015	12:20:00	665	1.26	49.95	50.04	665.18
01/08/2015	12:15:00	665	-3.13	49.95	50.04	660.38
01/08/2015	12:10:00	662.51	-4.98	50	50.04	656.25
01/08/2015	12:05:00	661.72	-4.48	50.05	50.04	658.54
01/08/2015	12:00:00	664.23	-2.06	50.05	50.04	664.39
01/08/2015	11:55:00	665	0.06	50.05	50.04	664.83
01/08/2015	11:50:00	665	1.93	50.05	50.04	667
01/08/2015	11:45:00	665	4.37	50	50.04	670.06
01/08/2015	11:40:00	665	4.99	49.95	50.04	670.11
01/08/2015	11:35:00	665	4.99	50	50.04	670.16
01/08/2015	11:30:00	665	4.85	50.05	49.97	669.94
01/08/2015	11:25:00	665	4.96	50	49.9	670.19
02/08/2015	00:40:00	666	-4.62	50.05	50.07	660.79
02/08/2015	00:35:00	666	-3.9	50.05	50.07	662.84
02/08/2015	00:30:00	666	0.04	50.05	50.02	668
02/08/2015	00:25:00	666	4	50	49.97	670.84
02/08/2015	00:20:00	666	4	49.95	49.97	669.5
02/08/2015	00:15:00	666	0.27	49.95	50.02	664.95
02/08/2015	00:10:00	666	-4.98	50	50.08	661.01
02/08/2015	00:05:00	666	-4.98	50.1	50.08	660.88
02/08/2015	00:00:00	666	-4.98	50.15	50.08	661.12
01/08/2015	23:55:00	666	-4.98	50.1	50.08	660.9
01/08/2015	23:50:00	666	-4.98	50.05	50.08	660.79
01/08/2015	23:45:00	666	-4.3	50.05	50.08	661.69
01/08/2015	23:40:00	666	-2.54	50.05	50.08	663.79
01/08/2015	23:35:00	666	-1.97	50.05	50.08	663.82
01/08/2015	23:30:00	666	-0.55	50.05	50	665.7
01/08/2015	23:25:00	666	1.94	50.05	49.93	667.81
01/08/2015	23:20:00	666	1.94	50	49.93	667.68
01/08/2015	23:15:00	666	1.94	49.95	49.98	668.2
01/08/2015	23:10:00	666	0.26	50	50.04	665.32
01/08/2015	23:05:00	666	-1.69	50.05	50.04	664.62
01/08/2015	23:00:00	666	-0.02	50.05	50.04	667.09
01/08/2015	22:55:00	666	1.94	50.05	50.04	668.15

01/08/2015	22:50:00	666	1.94	50	50.04	667.87
01/08/2015	22:45:00	666	1.94	49.95	50.04	667.81
01/08/2015	22:40:00	666	1.94	49.95	50.04	667.5
01/08/2015	22:35:00	666	0.65	50	50.04	666.47
01/08/2015	22:30:00	666	0.73	50	49.99	667.15
01/08/2015	22:25:00	666	1.91	49.95	49.94	668.41
01/08/2015	22:20:00	666	1.91	49.95	49.94	668.12
01/08/2015	22:15:00	666	1.91	49.9	49.94	667.92
01/08/2015	22:10:00	666	1.91	49.85	49.94	668.04
01/08/2015	22:05:00	666	1.91	49.85	49.99	667.92
01/08/2015	22:00:00	666	1.89	49.95	50.04	668.12
01/08/2015	21:55:00	666	1.96	50.05	50.04	668.3
01/08/2015	21:50:00	666	1.96	50.05	50.04	667.83
01/08/2015	21:45:00	666	1.96	50.05	50.04	667.83
01/08/2015	21:40:00	666	1.96	50.05	50.04	668.17
01/08/2015	21:35:00	666	1.96	50.05	50.04	668.15
01/08/2015	21:30:00	666	1.96	50.05	50.04	668
01/08/2015	21:25:00	666	1.96	50.05	50.04	667.91
01/08/2015	21:20:00	666	1.96	50.05	50.04	667.7
01/08/2015	21:15:00	666	1.96	50	50.04	667.89
01/08/2015	21:10:00	666	1.96	49.95	50.04	668.17
01/08/2015	21:05:00	666	1.96	50	50.04	668.14
01/08/2015	21:00:00	666	1.96	50.05	50.04	668.34
01/08/2015	20:55:00	666	1.96	50.05	50.04	667.84
01/08/2015	20:50:00	666	1.65	50.05	50.04	667.86
01/08/2015	20:45:00	666	1.58	50	49.99	667.85
01/08/2015	20:40:00	666	1.98	49.95	49.94	668.05
01/08/2015	20:35:00	666	1.98	49.95	49.94	668.13
01/08/2015	20:30:00	666	1.98	49.95	49.94	668.29
01/08/2015	20:25:00	666	1.98	49.95	49.94	667.94
01/08/2015	20:20:00	666	1.98	49.95	49.94	667.78
01/08/2015	20:15:00	666	1.98	49.95	49.94	668.02
01/08/2015	20:10:00	667	1.98	49.95	49.94	670.05
01/08/2015	20:05:00	668	1.98	49.95	49.94	670.13
01/08/2015	20:00:00	668	1.98	49.95	49.94	669.86
01/08/2015	19:55:00	667.5	1.98	49.95	49.94	667.93
01/08/2015	19:50:00	667	1.98	49.95	49.99	667.42
01/08/2015	19:45:00	667	1.74	49.95	49.93	667.28
01/08/2015	19:40:00	667	1.9	49.9	49.81	666.94
01/08/2015	19:35:00	667	1.9	49.85	49.81	666.28
01/08/2015	19:30:00	667	1.9	49.85	49.87	666.83

01/08/2015	19:25:00	667	1.9	49.85	49.92	665.92
01/08/2015	19:20:00	665.01	1.9	49.9	49.97	664.8
01/08/2015	19:15:00	661.13	1.9	49.95	50.02	661.01
01/08/2015	19:10:00	652.92	1.42	50	50.02	649.77
01/08/2015	19:05:00	639.96	-0.54	50.05	50.02	634.45
01/08/2015	19:00:00	629.17	-1.83	50.05	50.02	623.2
01/08/2015	18:55:00	625	-1.95	50.05	50.02	622.55
01/08/2015	18:50:00	630	-1.95	50.05	50.02	630.29
01/08/2015	18:45:00	635	-0.35	50	50.02	637.38
01/08/2015	18:40:00	635	1.95	49.95	50.02	636.34
01/08/2015	18:35:00	630	-0.04	50	50.07	626.32
01/08/2015	18:30:00	625	-1.99	50.05	50.12	622.32
01/08/2015	18:25:00	625	-1.99	50.05	50.12	622.5
01/08/2015	18:20:00	625	-1.99	50.05	50.12	622.75
01/08/2015	18:15:00	625	-1.99	50.1	50.12	623.69
01/08/2015	18:10:00	625	-1.99	50.15	50.12	622.9
01/08/2015	18:05:00	625	-1.99	50.15	50.12	623.12
02/08/2015	07:20:00	600	4.94	49.95	49.94	604.61
02/08/2015	07:15:00	600	4.94	49.95	49.99	604.76
02/08/2015	07:10:00	600	4.94	49.95	50.04	605.32
02/08/2015	07:05:00	600	4.94	50	50.04	605.04
02/08/2015	07:00:00	600	4.94	50.05	50.04	604.33
02/08/2015	06:55:00	600	4.94	50.05	50.04	604.18
02/08/2015	06:50:00	600.78	4.94	50.05	50.04	609.49
02/08/2015	06:45:00	605.93	4.94	50	50.04	608.07
02/08/2015	06:40:00	601.42	2.52	49.95	50.04	600.3
02/08/2015	06:35:00	600.33	-0.73	50	50.04	600.05
02/08/2015	06:30:00	605.36	-0.68	50.05	50.04	607.44
02/08/2015	06:25:00	610	0	50.05	50.04	611.19
02/08/2015	06:20:00	605.56	0	50.05	50.04	604.38
02/08/2015	06:15:00	594.45	0	50.05	50.04	592.47
02/08/2015	06:10:00	583.91	0	50.1	50.04	582.13
02/08/2015	06:05:00	575.01	0	50.15	50.04	573.82
02/08/2015	06:00:00	570	0	50.1	50.04	569.62
02/08/2015	05:55:00	570	0	50.05	50.04	570.32
02/08/2015	05:50:00	570	0	50.05	50.04	569.68
02/08/2015	05:45:00	570	0	50.05	50.04	569.77
02/08/2015	05:40:00	570	0	50.05	50.04	569.99
02/08/2015	05:35:00	570	0	50.05	50.04	569.48
02/08/2015	05:30:00	570	0	50.05	50.04	570.66
02/08/2015	05:25:00	570	0	50.05	50.04	570.27

02/08/2015	05:20:00	570	0	50	50.04	569.81
02/08/2015	05:15:00	570	0	50	50.04	569.32
02/08/2015	05:10:00	576.12	0	50.05	50.04	577.54
02/08/2015	05:05:00	589.75	0	50.05	50.04	591.76
02/08/2015	05:00:00	598.64	0	50.05	50.04	599.25
02/08/2015	04:55:00	606.57	0	50.05	50.04	608.32
02/08/2015	04:50:00	618.4	0	50.05	50.04	622.34
02/08/2015	04:45:00	631.13	0	50.05	50.04	634.1
02/08/2015	04:40:00	639.32	0	50.02	50.04	639.97
02/08/2015	04:35:00	642.45	0	50.05	50.04	643.82
02/08/2015	04:30:00	649.98	0	50	49.98	651.81
02/08/2015	04:25:00	655	0	49.95	49.93	655.64
02/08/2015	04:20:00	659.99	2.48	49.95	49.93	664.33
02/08/2015	04:15:00	665	4.18	49.95	50	667.96
02/08/2015	04:10:00	665	1	50	50.08	665.56
02/08/2015	04:05:00	665	1.41	50.05	50.08	666.37
02/08/2015	04:00:00	665	3.88	50.05	50.08	669.9
02/08/2015	03:55:00	665	4.96	50.05	50.08	670.03
02/08/2015	03:50:00	665	4.96	50.05	50.08	670.42
02/08/2015	03:45:00	665	2.94	50.05	50.08	667.52
02/08/2015	03:40:00	665	0.09	50.05	50.08	664.79
02/08/2015	03:35:00	665	0.09	50.05	50.08	664.77
02/08/2015	03:30:00	665	0.09	50.05	50.08	664.65
02/08/2015	03:25:00	665	0.09	50.05	50.08	665.13
02/08/2015	03:20:00	665	0.84	50.05	50.08	665.71
02/08/2015	03:15:00	665	1.13	50.05	50.08	664.91
02/08/2015	03:10:00	665	0.02	50.1	50.08	664.53
02/08/2015	03:05:00	665	0.02	50.15	50.08	665.03
02/08/2015	03:00:00	665	0.02	50.1	50.08	665.04
02/08/2015	02:55:00	665	0.02	50.05	50.08	664.53
02/08/2015	02:50:00	665	0.02	50.05	50.08	665.18
02/08/2015	02:45:00	665	2.3	50.05	50.08	667.85
02/08/2015	02:40:00	665	4.92	50.05	50.08	670.26
02/08/2015	02:35:00	665	4.92	50.05	50.08	670.18
02/08/2015	02:30:00	665	4.92	50.05	50.08	670.44
02/08/2015	02:25:00	665	4.92	50.05	50.08	669.87
02/08/2015	02:20:00	665	4.92	50.05	50.08	669.35
02/08/2015	02:15:00	665	4.92	50.05	50.08	669.74
02/08/2015	02:10:00	665	4.92	50.05	50.08	671.33
02/08/2015	02:05:00	662.51	4.42	50.05	50.08	666.77
02/08/2015	02:00:00	654.77	2.06	50.05	50.08	652.38



02/08/2015	01:55:00	644.75	-2.48	50.05	50.08	638.86
02/08/2015	01:50:00	640	-4.95	50.05	50.08	634.88
02/08/2015	01:45:00	640	-4.93	50.05	50.08	635.04
02/08/2015	01:40:00	645.19	-5	50.05	50.08	642.6
02/08/2015	01:35:00	653.2	-4.9	50.05	50.08	651.3
02/08/2015	01:30:00	656	-0.9	50.05	50.08	657.09
02/08/2015	01:25:00	656	3.98	50.05	50.08	659.93
02/08/2015	01:20:00	656	3.98	50.05	50.08	660.07
02/08/2015	01:15:00	656	3.98	50.05	50.08	660.73
02/08/2015	01:10:00	656	1.74	50	50.08	656.31
02/08/2015	01:05:00	656	-2.5	50	50.08	651.64
02/08/2015	01:00:00	658.13	-0.84	50.05	50.02	660.45
02/08/2015	00:55:00	663.16	3.92	50	49.97	670.12
02/08/2015	00:50:00	666	3.92	49.95	49.97	670.61
02/08/2015	00:45:00	666	-0.09	50	50.02	664.77
02/08/2015	14:00:00	640	2.18	50.01	50.06	643.37
02/08/2015	13:55:00	640	4.91	49.96	50.06	644.48
02/08/2015	13:50:00	640	4.91	49.96	50.06	646.21
02/08/2015	13:45:00	640	4.91	49.96	50.06	644.44
02/08/2015	13:40:00	637.52	2.57	49.96	50.06	637.93
02/08/2015	13:35:00	632.53	-0.25	50.01	50.06	631.11
02/08/2015	13:30:00	630	1.97	50.06	50.06	632.77
02/08/2015	13:25:00	630	4.92	50.06	50.06	635.98
02/08/2015	13:20:00	633.62	4.92	50.06	50.06	639.5
02/08/2015	13:15:00	635	3.05	50.06	50.06	636.46
02/08/2015	13:10:00	635	0.05	50.06	50.06	633.96
02/08/2015	13:05:00	637.49	0.05	50.06	50.06	637.59
02/08/2015	13:00:00	642.48	2.13	50.06	50.06	647.3
02/08/2015	12:55:00	645	4.96	50.01	50.06	649.99
02/08/2015	12:50:00	645	4.96	49.95	50.06	650.52
02/08/2015	12:45:00	645	4.96	49.95	50.06	649.68
02/08/2015	12:40:00	645	4.96	49.95	50.06	647.89
02/08/2015	12:35:00	645	4.74	49.95	50.06	651.19
02/08/2015	12:30:00	649.98	3.31	50	50	657.51
02/08/2015	12:25:00	655.99	4.93	50.05	49.94	662.83
02/08/2015	12:20:00	658.49	4.93	50	49.94	664.63
02/08/2015	12:15:00	658.12	3.53	49.95	50.01	658.52
02/08/2015	12:10:00	653.1	0.48	50	50.08	651.19
02/08/2015	12:05:00	647.53	1.33	50.05	50.08	648.55
02/08/2015	12:00:00	640.02	3.71	50.05	50.08	642.98
02/08/2015	11:55:00	630.02	4.9	50.05	50.08	635.02

02/08/2015	11:50:00	624.96	3.03	50.05	50.08	625.32
02/08/2015	11:45:00	622.47	0.58	50.05	50.08	620.15
02/08/2015	11:40:00	620	0.79	50.05	50.08	621.03
02/08/2015	11:35:00	620	2.36	50.05	50.08	624.47
02/08/2015	11:30:00	624.47	4.07	50.05	50.08	631.02
02/08/2015	11:25:00	629.51	4.57	50.05	50.08	634.1
02/08/2015	11:20:00	630	2.62	50.05	50.08	631.55
02/08/2015	11:15:00	630	0.51	50.05	50.08	631
02/08/2015	11:10:00	630	0	50.05	50.08	628.1
02/08/2015	11:05:00	625.02	0	50.05	50.08	623.15
02/08/2015	11:00:00	619.92	1.28	50.05	50.03	620.36
02/08/2015	10:55:00	614.89	3.29	50.05	49.97	613.45
02/08/2015	10:50:00	605.01	2.04	50.05	49.97	603.74
02/08/2015	10:45:00	600	1.34	50.05	49.97	602.28
02/08/2015	10:40:00	600	3.56	50.05	49.97	602.86
02/08/2015	10:35:00	603	4.92	50.05	49.97	608.63
02/08/2015	10:30:00	608.01	4.84	50.05	49.97	614.59
02/08/2015	10:25:00	610	4.94	50	49.97	615.81
02/08/2015	10:20:00	608.05	4.94	49.95	49.97	611.07
02/08/2015	10:15:00	603.04	3.14	50	50.03	603.68
02/08/2015	10:10:00	600	0.03	50.05	50.09	599.75
02/08/2015	10:05:00	600	0.03	50.05	50.09	599.68
02/08/2015	10:00:00	600	0.03	50.05	50.09	600.84
02/08/2015	09:55:00	600	0.03	50.05	50.09	600.31
02/08/2015	09:50:00	600	0.03	50.05	50.09	599.84
02/08/2015	09:45:00	600	0.17	50.05	50.09	599.84
02/08/2015	09:40:00	600	0.1	50.05	50.09	600.05
02/08/2015	09:35:00	600	0.1	50.05	50.09	599.9
02/08/2015	09:30:00	600	2.23	50.05	50.09	601.98
02/08/2015	09:25:00	600.7	4.92	50.05	50.09	607.54
02/08/2015	09:20:00	605.74	4.92	50	50.09	614.01
02/08/2015	09:15:00	610	2.87	49.95	50.09	611.91
02/08/2015	09:10:00	610	0	50	50.09	607.88
02/08/2015	09:05:00	610	-2	50.05	50.09	611.39
02/08/2015	09:00:00	614.75	-0.26	50.05	50.01	620.38
02/08/2015	08:55:00	622.38	4.99	50	49.94	627.45
02/08/2015	08:50:00	620	4.99	49.95	49.94	624.56
02/08/2015	08:45:00	620	2.66	49.95	49.99	619.08
02/08/2015	08:40:00	617.49	-2.12	50	50.05	616.27
02/08/2015	08:35:00	617.73	-0.27	50.05	50.05	622.93
02/08/2015	08:30:00	625.38	3.22	50.05	50.05	627.91

02/08/2015	08:25:00	613.23	4.06	50.05	50.05	613.2
02/08/2015	08:20:00	597.87	0.62	50.05	50.05	594.91
02/08/2015	08:15:00	584.81	-2.91	50.05	50.05	581.33
02/08/2015	08:10:00	580.12	-3.38	50.05	50.05	575.61
02/08/2015	08:05:00	582.13	-0.87	50.05	50.05	583.33
02/08/2015	08:00:00	587.16	2.88	50.05	50.05	592.93
02/08/2015	07:55:00	590.7	4.93	50.05	50.05	596.67
02/08/2015	07:50:00	595.73	4.93	50.05	50.05	602.31
02/08/2015	07:45:00	600	4.73	50.05	49.99	605.47
02/08/2015	07:40:00	599.28	4.94	50.05	49.94	604.31
02/08/2015	07:35:00	598.48	4.94	50	49.94	604.63
02/08/2015	07:30:00	600	4.94	49.95	49.94	605.21
02/08/2015	07:25:00	600	4.94	49.95	49.94	605.68
02/08/2015	20:40:00	665.97	5	49.95	49.96	666.1
02/08/2015	20:35:00	665.97	5	49.95	49.96	666.26
02/08/2015	20:30:00	665.97	4.91	49.95	49.96	665.49
02/08/2015	20:25:00	665.97	4.99	49.95	49.96	666
02/08/2015	20:20:00	665.97	4.99	49.95	49.96	665.57
02/08/2015	20:15:00	665.97	4.99	49.95	49.96	666.47
02/08/2015	20:10:00	665.97	4.99	49.95	49.96	666.49
02/08/2015	20:05:00	665.97	4.99	49.95	49.96	665.97
02/08/2015	20:00:00	665.97	4.99	49.9	49.96	666.49
02/08/2015	19:55:00	665.97	4.99	49.85	49.96	665.8
02/08/2015	19:50:00	665.97	4.99	49.85	49.96	665.22
02/08/2015	19:45:00	665.97	4.99	49.9	49.96	667.4
02/08/2015	19:40:00	665.97	4.99	49.96	49.96	665.88
02/08/2015	19:35:00	667.69	4.99	49.96	49.96	666.32
02/08/2015	19:30:00	667.21	4.99	49.96	49.91	669.72
02/08/2015	19:25:00	665.63	4.99	49.96	49.86	669.32
02/08/2015	19:20:00	660.1	4.99	49.96	49.86	659.58
02/08/2015	19:15:00	648.15	2.82	49.9	49.94	646.94
02/08/2015	19:10:00	641.25	-2.56	49.96	50.02	641.14
02/08/2015	19:05:00	640.91	0.72	50.06	50.02	641.1
02/08/2015	19:00:00	636.67	4.57	50.06	50.02	636.54
02/08/2015	18:55:00	619.97	4.92	50.06	50.02	616.02
02/08/2015	18:50:00	580.93	4.92	50.06	50.02	582.11
02/08/2015	18:45:00	545.72	4.92	50.01	50.02	546.21
02/08/2015	18:40:00	516.87	3	50.01	50.02	517.48
02/08/2015	18:35:00	510.95	2.57	50.06	50.02	510.24
02/08/2015	18:30:00	510	4.52	50.06	50.02	509.44
02/08/2015	18:25:00	510	4.99	50.06	50.02	510.94

02/08/2015	18:20:00	519.8	4.99	50.01	50.02	522.67
02/08/2015	18:15:00	518.52	2.16	50.01	50.08	516.16
02/08/2015	18:10:00	510	-2.91	50.11	50.13	508.69
02/08/2015	18:05:00	512.24	-2.91	50.16	50.13	512.61
02/08/2015	18:00:00	523.46	0.86	50.11	50.08	527.16
02/08/2015	17:55:00	531.93	4.4	50.06	50.03	527.9
02/08/2015	17:50:00	523.68	2.04	50.06	50.03	519.13
02/08/2015	17:45:00	514.93	-1.36	50.06	50.03	512.19
02/08/2015	17:40:00	510	-2.97	50.11	50.03	510.55
02/08/2015	17:35:00	510	-2.97	50.11	50.03	510.38
02/08/2015	17:30:00	505	-2.88	50.06	50.09	502.39
02/08/2015	17:25:00	500	-2.94	50.06	50.15	500.28
02/08/2015	17:20:00	500	-2.94	50.06	50.15	500.2
02/08/2015	17:15:00	509.94	-2.94	50.11	50.15	510.67
02/08/2015	17:10:00	527.09	-2.94	50.16	50.15	527.63
02/08/2015	17:05:00	544.2	-2.94	50.16	50.1	546.78
02/08/2015	17:00:00	561.01	-2.94	50.11	50.05	563.49
02/08/2015	16:55:00	569.28	-2.94	50.06	50.05	570.76
02/08/2015	16:50:00	565.2	-2.94	50.06	50.05	565.17
02/08/2015	16:45:00	555.62	-2.94	50.06	50.12	556.61
02/08/2015	16:40:00	550.42	-2.94	50.11	50.2	549.31
02/08/2015	16:35:00	550	-2.94	50.16	50.2	549.66
02/08/2015	16:30:00	552.79	-2.94	50.16	50.13	553.43
02/08/2015	16:25:00	557.82	-2.94	50.16	50.06	559.25
02/08/2015	16:20:00	560	-2.94	50.16	50.06	560.37
02/08/2015	16:15:00	560	-2.94	50.16	50.06	560.43
02/08/2015	16:10:00	560	-2.94	50.16	50.06	559.33
02/08/2015	16:05:00	560	-2.94	50.16	50.06	559.09
02/08/2015	16:00:00	560	-2.73	50.11	50.06	559.79
02/08/2015	15:55:00	564	-2.97	50.06	50.06	565.43
02/08/2015	15:50:00	571.39	-0.84	50.06	50.06	573.29
02/08/2015	15:45:00	577.37	3.1	50.06	50.06	578.88
02/08/2015	15:40:00	580.71	4.99	50.06	50.06	582.2
02/08/2015	15:35:00	585.74	4.99	50.06	50.06	587.25
02/08/2015	15:30:00	592.85	1.27	50.06	50.06	593.5
02/08/2015	15:25:00	602.86	-2.95	50.06	50.06	605.72
02/08/2015	15:20:00	614.89	-2.95	50.06	50.06	617.07
02/08/2015	15:15:00	624.88	-2.52	50.11	50.06	627.43
02/08/2015	15:10:00	636.55	-3	50.16	50.06	639.31
02/08/2015	15:05:00	646.57	-3	50.16	50.06	648.86
02/08/2015	15:00:00	654.37	0.84	50.11	50.06	657.27

02/08/2015	14:55:00	659.4	4.53	50.06	50.06	663.47
02/08/2015	14:50:00	660	1.08	50.06	50.06	658.85
02/08/2015	14:45:00	660	-2.55	50.06	50.06	656.59
02/08/2015	14:40:00	660	-2.99	50.06	50.06	656.96
02/08/2015	14:35:00	660	-2.99	50.06	50.06	657.13
02/08/2015	14:30:00	660	-2.75	50.06	50.06	658.15
02/08/2015	14:25:00	655.01	-2.93	50.06	50.06	650.73
02/08/2015	14:20:00	645.02	-2.93	50.06	50.06	641.51
02/08/2015	14:15:00	640	-2.79	50.06	50.06	637.13
02/08/2015	14:10:00	640	-2.91	50.06	50.06	637.01
02/08/2015	14:05:00	640	-1.79	50.06	50.06	639.84
03/08/2015	03:20:00	645	-1.83	50.05	50.02	645.01
03/08/2015	03:15:00	645	1.14	50.05	50.02	647.6
03/08/2015	03:10:00	645	0.89	50.05	50.02	644.98
03/08/2015	03:05:00	649.52	-2.28	50.05	50.02	647.97
03/08/2015	03:00:00	654.55	-2.9	50.05	50.02	651.77
03/08/2015	02:55:00	655	-2.24	50.05	50.02	652.44
03/08/2015	02:50:00	655	-1.12	50.05	50.02	654.46
03/08/2015	02:45:00	655	-0.09	50.05	50.02	655.91
03/08/2015	02:40:00	655	0.7	50.05	50.02	655.59
03/08/2015	02:35:00	655	0.85	50.05	50.02	656.01
03/08/2015	02:30:00	655	2.38	50.05	50.02	658.55
03/08/2015	02:25:00	655	4.92	50	50.02	660.03
03/08/2015	02:20:00	655	4.92	50	50.02	660.15
03/08/2015	02:15:00	655	4.92	50.05	50.02	660.38
03/08/2015	02:10:00	655	4.55	50.05	50.02	659.04
03/08/2015	02:05:00	655	3.73	50.05	50.02	659.09
03/08/2015	02:00:00	655	4.16	50	50.02	660.14
03/08/2015	01:55:00	655	5	49.95	50.02	660.22
03/08/2015	01:50:00	655	5	49.95	50.02	660.03
03/08/2015	01:45:00	655	5	49.95	50.02	659.71
03/08/2015	01:40:00	655	5	49.95	50.02	660.58
03/08/2015	01:35:00	655	5	49.95	50.02	659.91
03/08/2015	01:30:00	655	5	49.95	50.02	659.83
03/08/2015	01:25:00	655	5	49.95	50.02	660.31
03/08/2015	01:20:00	655	5	50	50.02	659.97
03/08/2015	01:15:00	655	5	50.06	50.02	660.32
03/08/2015	01:10:00	655	5	50.06	50.02	659.8
03/08/2015	01:05:00	655	5	50.01	50.02	660.43
03/08/2015	01:00:00	655	4.85	49.95	49.97	659.56
03/08/2015	00:55:00	655	4.92	49.95	49.91	658.71

03/08/2015	00:50:00	656.22	4.92	49.95	49.91	660.78
03/08/2015	00:45:00	661.25	4.92	49.95	49.91	667.9
03/08/2015	00:40:00	665	4.92	49.95	49.91	670.26
03/08/2015	00:35:00	665	4.92	49.95	49.91	669.71
03/08/2015	00:30:00	665	4.89	49.95	49.91	669.9
03/08/2015	00:25:00	665	4.94	49.95	49.91	669.42
03/08/2015	00:20:00	665	4.94	49.9	49.91	671.14
03/08/2015	00:15:00	665	4.94	49.85	49.98	670.84
03/08/2015	00:10:00	662.77	1.56	49.85	50.05	662.1
03/08/2015	00:05:00	657.77	-2.38	49.95	50.1	652.73
03/08/2015	00:00:00	657.53	-0.41	50.06	50.07	661.85
02/08/2015	23:55:00	662.56	4.94	50.01	50	670.3
02/08/2015	23:50:00	665	4.94	49.96	50	668.43
02/08/2015	23:45:00	665	1.38	50.01	50.05	662.92
02/08/2015	23:40:00	665	-3	50.06	50.1	662.04
02/08/2015	23:35:00	665	-3	50.06	50.1	662.47
02/08/2015	23:30:00	665	0.26	50.06	50.03	665.82
02/08/2015	23:25:00	665	4.98	50.06	49.96	669.7
02/08/2015	23:20:00	665	4.05	50.06	49.96	670.04
02/08/2015	23:15:00	665	3.88	50.06	49.96	670.58
02/08/2015	23:10:00	665	4.96	50.01	49.96	670.06
02/08/2015	23:05:00	665	4.96	50.01	49.96	667.38
02/08/2015	23:00:00	665	4.96	50.06	49.96	664.97
02/08/2015	22:55:00	665	4.96	50.06	49.96	664.88
02/08/2015	22:50:00	665	4.96	50	49.96	664.89
02/08/2015	22:45:00	665	4.96	49.95	49.96	664.73
02/08/2015	22:40:00	665	4.96	49.95	49.96	664.58
02/08/2015	22:35:00	665	4.96	49.95	49.96	665.25
02/08/2015	22:30:00	665	4.96	50	49.96	665.61
02/08/2015	22:25:00	665	4.96	50.05	49.96	665.31
02/08/2015	22:20:00	665	4.96	50.05	49.96	665.3
02/08/2015	22:15:00	665	4.88	50.05	49.96	664.75
02/08/2015	22:10:00	665	4.94	50	49.96	664.84
02/08/2015	22:05:00	665	4.94	49.95	49.96	665.69
02/08/2015	22:00:00	665	4.77	50	49.96	665.09
02/08/2015	21:55:00	663.54	4.79	50.05	49.96	664.74
02/08/2015	21:50:00	666.99	5	50.05	49.96	667.3
02/08/2015	21:45:00	669	5	50.05	49.96	668.75
02/08/2015	21:40:00	669	5	50.05	49.96	668.83
02/08/2015	21:35:00	669	5	50	49.96	668.93
02/08/2015	21:30:00	669	5	50	49.96	668.8

02/08/2015	21:25:00	669	5	50	49.96	668.78
02/08/2015	21:20:00	669	5	49.95	49.96	669.45
02/08/2015	21:15:00	668.52	5	49.9	49.96	668.83
02/08/2015	21:10:00	667.79	5	49.9	49.96	666.44
02/08/2015	21:05:00	666.76	5	49.95	49.96	666.01
02/08/2015	21:00:00	665.97	5	49.95	49.96	666.94
02/08/2015	20:55:00	665.97	5	49.95	49.96	665.69
02/08/2015	20:50:00	665.97	5	49.95	49.96	665.98
02/08/2015	20:45:00	665.97	5	49.95	49.96	666.13
03/08/2015	10:00:00	662.47	4.37	50	49.93	669.18
03/08/2015	09:55:00	665	4.91	49.95	49.86	670.54
03/08/2015	09:50:00	665	4.91	49.95	49.86	669.63
03/08/2015	09:45:00	665	4.91	49.9	49.86	670.06
03/08/2015	09:40:00	665	4.91	49.85	49.86	670.35
03/08/2015	09:35:00	665	4.91	49.85	49.86	669.9
03/08/2015	09:30:00	662.53	4.91	49.9	49.92	666.07
03/08/2015	09:25:00	660	3.99	50	49.98	662.91
03/08/2015	09:20:00	659.94	3.09	50.05	49.98	665.65
03/08/2015	09:15:00	665	4.42	50	49.98	669.34
03/08/2015	09:10:00	661.67	4.99	49.95	49.98	664.95
03/08/2015	09:05:00	654.17	4.99	49.95	49.98	656.43
03/08/2015	09:00:00	645.01	3.08	49.95	49.98	645.71
03/08/2015	08:55:00	640	-0.04	49.95	49.98	640.28
03/08/2015	08:50:00	640	-0.04	49.95	49.98	638.99
03/08/2015	08:45:00	640	-0.04	49.95	49.98	638.99
03/08/2015	08:40:00	640	-0.04	49.95	49.98	641.2
03/08/2015	08:35:00	640	-0.04	50	49.98	640.49
03/08/2015	08:30:00	635.01	-0.04	50.05	49.98	634.07
03/08/2015	08:25:00	625.01	-0.04	50.05	49.98	623.11
03/08/2015	08:20:00	614.76	-0.04	50.05	49.98	613.41
03/08/2015	08:15:00	605.11	-0.74	50.02	50.03	602.96
03/08/2015	08:10:00	600	-2.93	50.1	50.08	597.51
03/08/2015	08:05:00	602.9	-2.93	50.15	50.08	600.83
03/08/2015	08:00:00	598.35	-1.45	50.1	50.03	595.36
03/08/2015	07:55:00	591.04	-0.02	50.05	49.98	589.93
03/08/2015	07:50:00	590	-0.02	50	49.98	590.45
03/08/2015	07:45:00	590	-0.02	49.95	49.98	589.66
03/08/2015	07:40:00	590.1	-0.02	49.95	49.98	590.19
03/08/2015	07:35:00	596.75	-0.02	49.95	49.98	599.48
03/08/2015	07:30:00	606.63	-0.02	49.95	49.98	608.66
03/08/2015	07:25:00	610	-0.02	49.95	49.98	609.64

03/08/2015	07:20:00	610	-0.02	49.95	49.98	610.11
03/08/2015	07:15:00	610	-0.02	49.95	49.98	610.14
03/08/2015	07:10:00	610	-0.02	50	49.98	609.98
03/08/2015	07:05:00	610	-0.02	50.05	49.98	609.42
03/08/2015	07:00:00	610	-0.02	50	49.93	610.09
03/08/2015	06:55:00	613.32	-0.02	49.95	49.88	614.09
03/08/2015	06:50:00	618.35	-0.02	49.95	49.88	619.36
03/08/2015	06:45:00	620	-0.02	49.95	49.88	620.53
03/08/2015	06:40:00	620	-0.02	49.95	49.88	619.89
03/08/2015	06:35:00	618.9	-0.02	49.95	49.88	617.15
03/08/2015	06:30:00	613.87	-0.02	49.9	49.88	612.46
03/08/2015	06:25:00	610	-0.02	49.85	49.88	608.6
03/08/2015	06:20:00	605.01	-0.02	49.9	49.88	602.94
03/08/2015	06:15:00	600	-0.02	49.95	49.95	599.93
03/08/2015	06:10:00	600	-0.38	49.95	50.02	599.22
03/08/2015	06:05:00	600	-1.84	50	50.02	597.13
03/08/2015	06:00:00	600	-1.96	50.05	50.02	599.58
03/08/2015	05:55:00	595.02	0	50	50.02	593.9
03/08/2015	05:50:00	585.01	0	49.95	50.02	584.12
03/08/2015	05:45:00	579.03	0	49.95	50.02	578.62
03/08/2015	05:40:00	586.2	0	49.92	50.02	587.61
03/08/2015	05:35:00	596.21	0	50	50.02	598.4
03/08/2015	05:30:00	600	0	50.05	50.02	600.23
03/08/2015	05:25:00	600	0	50.05	50.02	600.32
03/08/2015	05:20:00	600	0	50.05	50.02	599.35
03/08/2015	05:15:00	602.5	0	50	50.02	603.48
03/08/2015	05:10:00	611.39	0	49.95	50.02	613.95
03/08/2015	05:05:00	625.32	0	49.95	50.02	628.29
03/08/2015	05:00:00	637.13	0	49.95	50.02	640.79
03/08/2015	04:55:00	643.23	1.89	49.95	50.02	648.64
03/08/2015	04:50:00	645	4.93	49.95	50.02	649.98
03/08/2015	04:45:00	645	4.93	49.95	50.02	649.92
03/08/2015	04:40:00	645	4.93	49.95	50.02	650.05
03/08/2015	04:35:00	645	4.93	49.95	50.02	650.01
03/08/2015	04:30:00	645	4.93	49.95	50.02	650.5
03/08/2015	04:25:00	645	4.93	49.95	50.02	648.93
03/08/2015	04:20:00	642.51	4.93	49.95	50.02	646.95
03/08/2015	04:15:00	640	4.93	49.95	50.02	644.15
03/08/2015	04:10:00	635.59	2.73	49.95	50.02	636.44
03/08/2015	04:05:00	630.92	-0.42	50	50.02	632.61
03/08/2015	04:00:00	633.6	1.99	50.05	50.02	637.92



03/08/2015	03:55:00	635	4.94	50.05	50.02	640.19
03/08/2015	03:50:00	635	4.94	50.05	50.02	640.28
03/08/2015	03:45:00	635	2.3	50.05	50.02	635.63
03/08/2015	03:40:00	635	-1.94	50.05	50.02	631.79
03/08/2015	03:35:00	635.14	-2.94	50.05	50.02	633.64
03/08/2015	03:30:00	640.17	-2.94	50.05	50.02	639.89
03/08/2015	03:25:00	645	-2.94	50.05	50.02	641.76
03/08/2015	16:40:00	662	3.93	49.95	49.97	665.85
03/08/2015	16:35:00	662	3.93	50	49.97	665.33
03/08/2015	16:30:00	662	3.29	50	49.91	665.67
03/08/2015	16:25:00	662	4	49.9	49.85	666.09
03/08/2015	16:20:00	662	4	49.85	49.85	667.08
03/08/2015	16:15:00	662	2.7	49.85	49.95	662.27
03/08/2015	16:10:00	656.99	0.63	49.95	50.05	655.83
03/08/2015	16:05:00	657.17	2.57	50.05	49.99	662.3
03/08/2015	16:00:00	662	3.97	50	49.89	666.57
03/08/2015	15:55:00	662	3.97	49.9	49.84	665.87
03/08/2015	15:50:00	662	3.97	49.85	49.89	665.61
03/08/2015	15:45:00	662	3.97	49.9	49.94	666.33
03/08/2015	15:40:00	662	3.97	49.95	49.94	665.88
03/08/2015	15:35:00	662	3.97	50	49.94	665.88
03/08/2015	15:30:00	662	3.38	50	49.94	666.53
03/08/2015	15:25:00	662	3.91	49.95	49.99	665.82
03/08/2015	15:20:00	662	3.91	49.95	50.04	665.82
03/08/2015	15:15:00	662	3.26	49.95	50.04	664.53
03/08/2015	15:10:00	661.51	1.24	50	50.04	662.43
03/08/2015	15:05:00	661	2.1	50.05	50.04	664.46
03/08/2015	15:00:00	661	3.59	50	49.99	665.52
03/08/2015	14:55:00	661	4	49.95	49.94	665.62
03/08/2015	14:50:00	661	4.49	49.95	49.94	665.47
03/08/2015	14:45:00	661	4.98	49.95	49.94	665.76
03/08/2015	14:40:00	661	4.98	50	49.94	666.11
03/08/2015	14:35:00	661	4.98	50.05	49.94	666.82
03/08/2015	14:30:00	661	4.98	50	49.94	665.99
03/08/2015	14:25:00	661	4.98	49.95	49.94	666.18
03/08/2015	14:20:00	661	4.98	49.95	49.94	666.12
03/08/2015	14:15:00	661	4.98	49.95	49.94	666.05
03/08/2015	14:10:00	661	4.98	50	49.94	666.2
03/08/2015	14:05:00	661	4.98	50.05	49.94	666.54
03/08/2015	14:00:00	661	4.81	50.05	49.94	665.83
03/08/2015	13:55:00	661	4.9	50.05	49.94	665.71

03/08/2015	13:50:00	661	4.9	50	49.94	666.54
03/08/2015	13:45:00	661	4.9	49.95	49.99	666.54
03/08/2015	13:40:00	661	4.9	49.95	50.05	665.69
03/08/2015	13:35:00	659.81	4.9	49.95	50.05	663.05
03/08/2015	13:30:00	656.8	4.54	49.95	50.05	662.21
03/08/2015	13:25:00	659.81	5	49.95	50.05	667.06
03/08/2015	13:20:00	660.52	5	50	50.05	664.88
03/08/2015	13:15:00	660	1	50.05	50.05	659.39
03/08/2015	13:10:00	658.57	-2.98	50.05	50.05	655.72
03/08/2015	13:05:00	656.04	-2.98	50.05	50.05	652.14
03/08/2015	13:00:00	655	-2.81	50.05	50.05	652.14
03/08/2015	12:55:00	655	-2.92	50.05	50.05	651.63
03/08/2015	12:50:00	655	-2.92	50.05	50.05	651.07
03/08/2015	12:45:00	655	0.27	50.05	50.05	655.98
03/08/2015	12:40:00	657.98	4.96	50.05	50.05	663.94
03/08/2015	12:35:00	661	4.96	50	50.05	665.79
03/08/2015	12:30:00	661	4.96	49.95	50.05	666.23
03/08/2015	12:25:00	661	4.96	49.95	50.05	666.89
03/08/2015	12:20:00	661	4.26	50	50.05	665.53
03/08/2015	12:15:00	661	4.25	50	50.05	665.28
03/08/2015	12:10:00	660.51	4.94	49.92	50.05	664.02
03/08/2015	12:05:00	660	4.55	50	50.05	664.61
03/08/2015	12:00:00	660	4.69	50	50	664.61
03/08/2015	11:55:00	660	4.96	49.95	49.95	664.61
03/08/2015	11:50:00	660	4.96	49.95	49.95	666.47
03/08/2015	11:45:00	660	4.96	49.95	50.02	665.51
03/08/2015	11:40:00	655.02	2.62	50	50.09	655.25
03/08/2015	11:35:00	650	-0.94	50.05	50.09	648.31
03/08/2015	11:30:00	651.58	0.73	50.05	50.03	655.82
03/08/2015	11:25:00	657.1	4.99	50.05	49.97	664.61
03/08/2015	11:20:00	661	4.99	50	49.97	665.88
03/08/2015	11:15:00	661	4.99	49.95	49.97	666.14
03/08/2015	11:10:00	661	4.99	49.95	49.97	666.11
03/08/2015	11:05:00	661	4.99	49.95	49.97	665.87
03/08/2015	11:00:00	661	4.81	50	49.97	665.97
03/08/2015	10:55:00	661	4.92	50.05	49.97	665.88
03/08/2015	10:50:00	661	4.92	50	49.97	666.1
03/08/2015	10:45:00	662.47	4.92	49.95	49.97	668.94
03/08/2015	10:40:00	664	4.92	49.95	49.97	669.21
03/08/2015	10:35:00	664	4.92	49.95	49.97	668.69
03/08/2015	10:30:00	664	4.92	49.95	49.91	669.13

03/08/2015	10:25:00	664	4.92	49.9	49.85	669.03
03/08/2015	10:20:00	664	4.92	49.84	49.85	669.36
03/08/2015	10:15:00	662.53	4.92	49.84	49.93	666.27
03/08/2015	10:10:00	662.23	3.64	49.89	50	664.16
03/08/2015	10:05:00	660	2.71	50	50	665.07
03/08/2015	23:20:00	665	3.92	50.05	49.99	669.08
03/08/2015	23:15:00	665	3.92	50.05	49.99	669.18
03/08/2015	23:10:00	665	3.92	50.05	49.99	669.06
03/08/2015	23:05:00	665	3.92	50.05	49.99	669.17
03/08/2015	23:00:00	665	3.58	50.05	49.99	668.66
03/08/2015	22:55:00	665	3.91	50.05	49.99	668.83
03/08/2015	22:50:00	665	3.91	50.05	49.99	669.23
03/08/2015	22:45:00	665	3.91	50	49.94	669.15
03/08/2015	22:40:00	665	3.91	49.95	49.89	668.99
03/08/2015	22:35:00	665	3.91	49.95	49.89	669.12
03/08/2015	22:30:00	665	3.91	49.9	49.89	668.38
03/08/2015	22:25:00	665	3.91	49.85	49.89	668.87
03/08/2015	22:20:00	665	3.91	49.85	49.94	668.78
03/08/2015	22:15:00	665	3.91	49.85	49.99	668.7
03/08/2015	22:10:00	665	3.91	49.85	49.99	669.4
03/08/2015	22:05:00	665	3.91	49.9	49.99	668.34
03/08/2015	22:00:00	665	3.52	50	49.99	667.19
03/08/2015	21:55:00	665	4	50.05	49.99	666.06
03/08/2015	21:50:00	667.51	4	50	49.99	669.04
03/08/2015	21:45:00	670	4	49.95	49.99	670.19
03/08/2015	21:40:00	670	4	50	49.99	670.12
03/08/2015	21:35:00	670	4	50.05	49.99	670.08
03/08/2015	21:30:00	670	4	50	49.94	670.06
03/08/2015	21:25:00	670	4	49.95	49.89	669.59
03/08/2015	21:20:00	670	4	49.9	49.89	670.2
03/08/2015	21:15:00	672.49	4	49.8	49.89	674.08
03/08/2015	21:10:00	675	4	49.75	49.89	674
03/08/2015	21:05:00	672.49	4	49.8	49.89	670.78
03/08/2015	21:00:00	670	4	49.86	49.89	670.36
03/08/2015	20:55:00	670	4	49.86	49.89	669.71
03/08/2015	20:50:00	670	4	49.86	49.89	670.32
03/08/2015	20:45:00	670	4	49.91	49.89	670.32
03/08/2015	20:40:00	670	4	49.96	49.89	669.6
03/08/2015	20:35:00	670	4	49.96	49.89	670.27
03/08/2015	20:30:00	670	4	49.96	49.89	670.57
03/08/2015	20:25:00	670	4	49.9	49.89	669.99

03/08/2015	20:20:00	667.49	4	49.85	49.89	666.47
03/08/2015	20:15:00	665	4	49.85	49.89	665.77
03/08/2015	20:10:00	665	4	49.91	49.89	664.62
03/08/2015	20:05:00	665	4	49.96	49.89	664.46
03/08/2015	20:00:00	665	4	49.96	49.89	665.37
03/08/2015	19:55:00	664.51	4	49.96	49.89	664.91
03/08/2015	19:50:00	668.99	4	49.91	49.89	669.83
03/08/2015	19:45:00	674	4	49.85	49.83	674.99
03/08/2015	19:40:00	674	4	49.8	49.76	674.27
03/08/2015	19:35:00	674	4	49.75	49.71	674.08
03/08/2015	19:30:00	674	4	49.65	49.66	674.1
03/08/2015	19:25:00	672.02	4	49.6	49.66	672.1
03/08/2015	19:20:00	669.69	4	49.65	49.66	670.13
03/08/2015	19:15:00	667.17	4	49.65	49.76	669.48
03/08/2015	19:10:00	665	4	49.75	49.86	669.04
03/08/2015	19:05:00	665	4	49.9	49.86	669.14
03/08/2015	19:00:00	665	4	49.9	49.86	668.72
03/08/2015	18:55:00	665	4	49.85	49.81	668.58
03/08/2015	18:50:00	665	4	49.85	49.76	669
03/08/2015	18:45:00	665	4	49.85	49.86	669.34
03/08/2015	18:40:00	664.52	4	49.9	49.96	668.76
03/08/2015	18:35:00	664	4	50	49.96	668.07
03/08/2015	18:30:00	664	4	49.95	49.93	668.77
03/08/2015	18:25:00	664	4	49.95	49.97	668.05
03/08/2015	18:20:00	664	4	50	49.97	668.1
03/08/2015	18:15:00	664	4	49.95	49.97	667.77
03/08/2015	18:10:00	663.01	4	49.95	49.97	666.53
03/08/2015	18:05:00	662	4	50	49.97	666.38
03/08/2015	18:00:00	662.99	4	50	49.97	667.07
03/08/2015	17:55:00	662	4	49.95	49.97	666.29
03/08/2015	17:50:00	662	4	49.95	49.97	665.67
03/08/2015	17:45:00	662	4	49.95	49.97	666.48
03/08/2015	17:40:00	662	4	49.95	49.97	665.63
03/08/2015	17:35:00	662	4	50	49.97	666.24
03/08/2015	17:30:00	662	4	50.05	49.97	666.28
03/08/2015	17:25:00	662	4	50.05	49.97	665.78
03/08/2015	17:20:00	662	4	50.05	49.97	666.54
03/08/2015	17:15:00	662	3.83	50.05	49.97	665.08
03/08/2015	17:10:00	662	3.24	50.05	49.97	665.11
03/08/2015	17:05:00	662	3.62	50.05	49.97	666.28
03/08/2015	17:00:00	662	3.93	50	49.97	666.19

03/08/2015	16:55:00	662	3.93	49.95	49.97	666.01
03/08/2015	16:50:00	662	3.93	49.95	49.97	666.02
03/08/2015	16:45:00	662	3.93	49.95	49.97	666.04

**UNIT WITHOUT UI CORRECTION**

Date	Time	Operator Set Point	UI Correction	Block Avg Frequency	Instantaneous Frequency	Corrected MW
01/08/2015	04:40:00	670	0	50	50	669.79
01/08/2015	04:35:00	670	0	50.05	50	670.53
01/08/2015	04:30:00	670	0	50.05	50	670.49
01/08/2015	04:25:00	670	0	50.05	50	669.81
01/08/2015	04:20:00	670	0	50.05	50	669.81
01/08/2015	04:15:00	670	0	50.05	50	670.19
01/08/2015	04:10:00	670	0	50.05	50	669.86
01/08/2015	04:05:00	670	0	50.05	50	669.94
01/08/2015	04:00:00	670	0	50.05	50	670.45
01/08/2015	03:55:00	670	0	50.05	50	670.3
01/08/2015	03:50:00	670	0	50.05	50	670.07
01/08/2015	03:45:00	670	0	50	50	669.34
01/08/2015	03:40:00	670	0	49.95	50	669.81
01/08/2015	03:35:00	670	0	49.95	50	670.25
01/08/2015	03:30:00	670	0	49.95	50	669.45
01/08/2015	03:25:00	670	0	49.95	50	670.23
01/08/2015	03:20:00	670	0	49.95	50	669.72
01/08/2015	03:15:00	670	0	49.95	50	670.05
01/08/2015	03:10:00	670	0	49.95	50	669.98
01/08/2015	03:05:00	670	0	50	50	669.96
01/08/2015	03:00:00	670	0	50.05	50	670.13
01/08/2015	02:55:00	670	0	50.05	50	670.15
01/08/2015	02:50:00	670	0	50	50	669.66
01/08/2015	02:45:00	670	0	49.95	50	669.66
01/08/2015	02:40:00	670	0	50	50	670.6
01/08/2015	02:35:00	670	0	50.05	50	670.42
01/08/2015	02:30:00	670	0	50	49.93	669.49
01/08/2015	02:25:00	670	0	49.9	49.86	669.82
01/08/2015	02:20:00	670	0	49.85	49.86	669.81
01/08/2015	02:15:00	670	0	49.9	49.91	669.63

01/08/2015	02:10:00	670	0	49.96	49.96	669.87
01/08/2015	02:05:00	670	0	50.01	49.96	669.87
01/08/2015	02:00:00	670	0	50.06	49.96	670.52
01/08/2015	01:55:00	670	0	50	49.91	670.24
01/08/2015	01:50:00	670	0	49.95	49.86	669.93
01/08/2015	01:45:00	670	0	49.9	49.93	670.33
01/08/2015	01:40:00	670	0	49.96	49.99	670.09
01/08/2015	01:35:00	670	0	50.01	49.99	669.78
01/08/2015	01:30:00	670	0	49.96	49.99	670.3
01/08/2015	01:25:00	670	0	49.96	49.99	669.78
01/08/2015	01:20:00	670	0	49.96	49.99	669.66
01/08/2015	01:15:00	670	0	49.96	49.99	670.47
01/08/2015	01:10:00	670	0	49.96	49.99	669.8
01/08/2015	01:05:00	670	0	49.96	49.99	669.63
01/08/2015	01:00:00	670	0	49.96	49.99	669.89
01/08/2015	00:55:00	670	0	49.96	49.99	670.4
01/08/2015	00:50:00	670	0	49.96	49.99	670.61
01/08/2015	00:45:00	670	0	49.96	49.99	670.51
01/08/2015	00:40:00	670	0	49.96	49.99	670.2
01/08/2015	00:35:00	670	0	49.96	49.99	669.72
01/08/2015	00:30:00	670	0	49.96	49.99	669.94
01/08/2015	00:25:00	670	0	49.96	49.99	670.13
01/08/2015	00:20:00	670	0	49.96	49.99	669.8
01/08/2015	00:15:00	670	0	49.96	49.99	670.36
01/08/2015	00:10:00	670	0	49.96	49.99	669.85
01/08/2015	00:05:00	670	0	49.96	50.04	670.43
01/08/2015	00:00:00	670	0	50.01	50.09	670.06
01/08/2015	11:20:00	670	0	49.95	49.9	670.45
01/08/2015	11:15:00	670	0	49.95	49.95	670.19
01/08/2015	11:10:00	670	0	49.95	50.01	670.12
01/08/2015	11:05:00	670	0	49.95	50.01	670.8
01/08/2015	11:00:00	670	0	49.95	50.01	670.27
01/08/2015	10:55:00	670	0	49.95	50.01	670.27
01/08/2015	10:50:00	670	0	49.95	50.01	669.87
01/08/2015	10:45:00	670	0	49.95	50.01	670.38
01/08/2015	10:40:00	670	0	49.95	50.01	669.78
01/08/2015	10:35:00	670	0	49.95	50.01	669.43
01/08/2015	10:30:00	670	0	49.95	50.01	670.18
01/08/2015	10:25:00	670	0	49.95	50.01	669.98
01/08/2015	10:20:00	670	0	49.95	50.01	670.65
01/08/2015	10:15:00	670	0	49.95	50.01	669.03

01/08/2015	10:10:00	665	0	49.95	50.01	661.49
01/08/2015	10:05:00	660.4	0	50	50.01	662.3
01/08/2015	10:00:00	665.43	0	50.05	50.01	667.82
01/08/2015	09:55:00	670	0	50	50.01	669.75
01/08/2015	09:50:00	670	0	49.95	50.01	669.74
01/08/2015	09:45:00	670	0	49.95	49.96	670.07
01/08/2015	09:40:00	670	0	49.95	49.91	669.71
01/08/2015	09:35:00	670	0	49.95	49.91	670.23
01/08/2015	09:30:00	670	0	49.95	49.96	670.24
01/08/2015	09:25:00	670	0	50	49.96	670.39
01/08/2015	09:20:00	670	0	50.05	49.91	670.26
01/08/2015	09:15:00	665.03	0	50	49.97	663.97
01/08/2015	09:10:00	655.03	0	50	50.03	654.57
01/08/2015	09:05:00	654.97	0	50.05	50.03	655.12
01/08/2015	09:00:00	660	0	50.05	50.03	660.23
01/08/2015	08:55:00	663.74	0	50.05	50.03	664.73
01/08/2015	08:50:00	668.77	0	50.05	50.03	669.93
01/08/2015	08:45:00	670	0	50.05	50.03	669.89
01/08/2015	08:40:00	670	0	50.05	50.03	669.59
01/08/2015	08:35:00	670	0	50.05	50.03	669.98
01/08/2015	08:30:00	670	0	50	50.03	670.25
01/08/2015	08:25:00	670	0	49.95	50.03	670.06
01/08/2015	08:20:00	670	0	49.95	50.03	670.5
01/08/2015	08:15:00	670	0	49.95	50.03	670.36
01/08/2015	08:10:00	670	0	50	50.03	670.09
01/08/2015	08:05:00	670	0	50.06	50.03	670.52
01/08/2015	08:00:00	670	0	50.06	50.03	669.71
01/08/2015	07:55:00	670	0	50.06	50.03	669.72
01/08/2015	07:50:00	670	0	50.06	50.03	670.21
01/08/2015	07:45:00	670	0	50.06	49.98	670.21
01/08/2015	07:40:00	670	0	50.01	49.93	670.21
01/08/2015	07:35:00	670	0	49.95	49.93	670.21
01/08/2015	07:30:00	670	0	49.95	49.93	669.81
01/08/2015	07:25:00	670	0	49.95	49.93	669.82
01/08/2015	07:20:00	670	0	49.95	49.93	669.93
01/08/2015	07:15:00	670	0	50.01	49.93	669.84
01/08/2015	07:10:00	670	0	50.06	49.93	669.84
01/08/2015	07:05:00	670	0	50	49.93	669.9
01/08/2015	07:00:00	670	0	49.95	49.98	670.25
01/08/2015	06:55:00	670	0	49.95	50.04	669.73
01/08/2015	06:50:00	670	0	49.95	50.04	669.73

01/08/2015	06:45:00	670	0	49.95	50.04	669.74
01/08/2015	06:40:00	670	0	49.95	50.04	670.58
01/08/2015	06:35:00	670	0	49.95	50.04	670.22
01/08/2015	06:30:00	670	0	50	49.97	670.22
01/08/2015	06:25:00	670	0	50.06	49.89	669.89
01/08/2015	06:20:00	670	0	50	49.89	669.83
01/08/2015	06:15:00	670	0	49.95	50	669.91
01/08/2015	06:10:00	670	0	50	50.1	669.76
01/08/2015	06:05:00	670	0	50.05	50.1	669.93
01/08/2015	06:00:00	670	0	50.05	50.05	670.32
01/08/2015	05:55:00	670	0	50.05	50	670.38
01/08/2015	05:50:00	670	0	50.05	50	670.16
01/08/2015	05:45:00	670	0	50.05	50	669.67
01/08/2015	05:40:00	670	0	50.05	50	670.2
01/08/2015	05:35:00	670	0	50.05	50	669.79
01/08/2015	05:30:00	670	0	50.05	50	669.82
01/08/2015	05:25:00	670	0	50.05	50	670.85
01/08/2015	05:20:00	670	0	50.05	50	669.97
01/08/2015	05:15:00	668	0	50.05	50	666.55
01/08/2015	05:10:00	662.97	0	50.05	50	661.35
01/08/2015	05:05:00	664.97	0	50.05	50	665.38
01/08/2015	05:00:00	670	0	50.05	50	670.66
01/08/2015	04:55:00	670	0	50.05	50	669.99
01/08/2015	04:50:00	670	0	50	50	669.77
01/08/2015	04:45:00	670	0	49.95	50	670.02
01/08/2015	18:00:00	605	0	50.1	50.07	605.45
01/08/2015	17:55:00	605	0	50.05	50.02	604.98
01/08/2015	17:50:00	605	0	50.05	50.02	605.13
01/08/2015	17:45:00	605	0	50.05	50.02	605.02
01/08/2015	17:40:00	605	0	50.05	50.02	604.96
01/08/2015	17:35:00	605	0	50.05	50.02	605
01/08/2015	17:30:00	605	0	50.05	50.07	605.1
01/08/2015	17:25:00	605	0	50.05	50.13	605.5
01/08/2015	17:20:00	605	0	50.05	50.13	605.15
01/08/2015	17:15:00	605	0	50.05	50.13	604.61
01/08/2015	17:10:00	605	0	50.1	50.13	605.95
01/08/2015	17:05:00	612.9	0	50.15	50.08	615.04
01/08/2015	17:00:00	620.87	0	50.1	50.02	620.11
01/08/2015	16:55:00	620.87	0	50.05	50.02	621.28
01/08/2015	16:50:00	620.87	0	50.05	50.02	621.36
01/08/2015	16:45:00	620.87	0	50.05	50.02	621.17



01/08/2015	16:40:00	620.87	0	50.05	50.02	620.25
01/08/2015	16:35:00	620.87	0	50.05	50.02	620.9
01/08/2015	16:30:00	620.87	0	50.05	50.02	621.42
01/08/2015	16:25:00	620.87	0	50.05	50.02	621.59
01/08/2015	16:20:00	620.87	0	50.05	50.02	619.73
01/08/2015	16:15:00	620.87	0	50.05	50.02	619.11
01/08/2015	16:10:00	620.87	0	50.05	50.02	622.38
01/08/2015	16:05:00	629.9	0	50.05	50.02	633.5
01/08/2015	16:00:00	639.94	0	50.05	49.97	641.23
01/08/2015	15:55:00	640.87	0	50.05	49.92	640
01/08/2015	15:50:00	635.87	0	50	49.92	633.21
01/08/2015	15:45:00	630.95	0	49.95	49.98	631.17
01/08/2015	15:40:00	632.06	0	49.95	50.03	632.77
01/08/2015	15:35:00	642.31	0	49.95	50.03	642.99
01/08/2015	15:30:00	659.09	0	49.95	50.03	658.1
01/08/2015	15:25:00	664.59	0	49.95	50.03	664.99
01/08/2015	15:20:00	661.77	0	49.95	50.03	660.54
01/08/2015	15:15:00	657.72	0	50	50.03	657.52
01/08/2015	15:10:00	659.09	0	50.1	50.03	659.29
01/08/2015	15:05:00	663.27	0	50.1	50.03	662.98
01/08/2015	15:00:00	658.59	0	50	49.98	658.68
01/08/2015	14:55:00	658.63	0	49.95	49.92	659.94
01/08/2015	14:50:00	667.59	0	49.95	49.92	667.75
01/08/2015	14:45:00	664.72	0	49.95	49.92	664.38
01/08/2015	14:40:00	651.61	0	49.95	49.92	652.19
01/08/2015	14:35:00	654.73	0	50	49.92	655.75
01/08/2015	14:30:00	663.03	0	50.05	49.92	660.59
01/08/2015	14:25:00	660	0	50.05	49.92	662.61
01/08/2015	14:20:00	662.97	0	50	49.92	666.16
01/08/2015	14:15:00	666	0	49.95	49.98	663.89
01/08/2015	14:10:00	661.23	0	50	50.03	658.97
01/08/2015	14:05:00	660.56	0	50.05	50.03	662.22
01/08/2015	14:00:00	665.8	0	50	49.98	664.59
01/08/2015	13:55:00	663	0	49.95	49.93	662.68
01/08/2015	13:50:00	660	0	49.95	49.93	660.82
01/08/2015	13:45:00	654.77	0	49.95	49.98	652.5
01/08/2015	13:40:00	644.77	0	50	50.04	642.32
01/08/2015	13:35:00	640	0	50.05	50.04	639.05
01/08/2015	13:30:00	640	0	50.05	50.09	640.67
01/08/2015	13:25:00	640	0	50.05	50.14	640.01
01/08/2015	13:20:00	640	0	50.05	50.14	640.06

01/08/2015	13:15:00	640	0	50.1	50.14	640.22
01/08/2015	13:10:00	640	0	50.15	50.14	640.23
01/08/2015	13:05:00	640	0	50.15	50.14	640.17
01/08/2015	13:00:00	640	0	50.1	50.09	640.13
01/08/2015	12:55:00	642.47	0	50.05	50.04	643.86
01/08/2015	12:50:00	647.5	0	50.05	50.04	649.37
01/08/2015	12:45:00	645.03	0	50	50.04	642.5
01/08/2015	12:40:00	640	0	50	50.04	638.88
01/08/2015	12:35:00	644.37	0	50.05	50.04	645.72
01/08/2015	12:30:00	654.35	0	50.05	50.04	656.92
01/08/2015	12:25:00	660	0	50	50.04	659.47
01/08/2015	12:20:00	655.03	0	49.95	50.04	651.44
01/08/2015	12:15:00	650	0	49.95	50.04	649.67
01/08/2015	12:10:00	650.17	0	50	50.04	651.4
01/08/2015	12:05:00	655.66	0	50.05	50.04	660.03
01/08/2015	12:00:00	665.43	0	50.05	50.04	669.03
01/08/2015	11:55:00	670	0	50.05	50.04	669.9
01/08/2015	11:50:00	670	0	50.05	50.04	670.14
01/08/2015	11:45:00	670	0	50	50.04	670.38
01/08/2015	11:40:00	670	0	49.95	50.04	670.27
01/08/2015	11:35:00	670	0	50	50.04	670.2
01/08/2015	11:30:00	670	0	50.05	49.97	670.22
01/08/2015	11:25:00	670	0	50	49.9	670.28
02/08/2015	00:40:00	666	0	50.05	50.07	666.22
02/08/2015	00:35:00	666	0	50.05	50.07	665.48
02/08/2015	00:30:00	666	0	50.05	50.02	665.85
02/08/2015	00:25:00	666	0	50	49.97	666
02/08/2015	00:20:00	665.53	0	49.95	49.97	665.99
02/08/2015	00:15:00	665	0	49.95	50.02	665.09
02/08/2015	00:10:00	660	0	50	50.08	659.53
02/08/2015	00:05:00	649.16	0	50.1	50.08	651.78
02/08/2015	00:00:00	652.17	0	50.15	50.08	653.91
01/08/2015	23:55:00	655	0	50.1	50.08	655.1
01/08/2015	23:50:00	657.47	0	50.05	50.08	656.9
01/08/2015	23:45:00	662.95	0	50.05	50.08	665.22
01/08/2015	23:40:00	666	0	50.05	50.08	666.23
01/08/2015	23:35:00	666	0	50.05	50.08	666.25
01/08/2015	23:30:00	666	0	50.05	50	665.91
01/08/2015	23:25:00	666	0	50.05	49.93	665.78
01/08/2015	23:20:00	666	0	50	49.93	665.63
01/08/2015	23:15:00	666	0	49.95	49.98	666.5

01/08/2015	23:10:00	666	0	50	50.04	666.1
01/08/2015	23:05:00	666	0	50.05	50.04	665.64
01/08/2015	23:00:00	666	0	50.05	50.04	665.89
01/08/2015	22:55:00	666	0	50.05	50.04	666.25
01/08/2015	22:50:00	666	0	50	50.04	665.88
01/08/2015	22:45:00	666	0	49.95	50.04	666.29
01/08/2015	22:40:00	666	0	49.95	50.04	665.66
01/08/2015	22:35:00	666	0	50	50.04	665.53
01/08/2015	22:30:00	666	0	50	49.99	666.29
01/08/2015	22:25:00	666	0	49.95	49.94	666.09
01/08/2015	22:20:00	666	0	49.95	49.94	665.64
01/08/2015	22:15:00	666	0	49.9	49.94	665.66
01/08/2015	22:10:00	666	0	49.85	49.94	666
01/08/2015	22:05:00	666	0	49.85	49.99	666.18
01/08/2015	22:00:00	666	0	49.95	50.04	665.9
01/08/2015	21:55:00	666	0	50.05	50.04	665.9
01/08/2015	21:50:00	666	0	50.05	50.04	666.27
01/08/2015	21:45:00	666	0	50.05	50.04	666.18
01/08/2015	21:40:00	666	0	50.05	50.04	665.91
01/08/2015	21:35:00	666	0	50.05	50.04	665.93
01/08/2015	21:30:00	666	0	50.05	50.04	666.17
01/08/2015	21:25:00	666	0	50.05	50.04	666.21
01/08/2015	21:20:00	666	0	50.05	50.04	666.25
01/08/2015	21:15:00	666	0	50	50.04	665.94
01/08/2015	21:10:00	666	0	49.95	50.04	665.67
01/08/2015	21:05:00	666	0	50	50.04	665.99
01/08/2015	21:00:00	666	0	50.05	50.04	666.53
01/08/2015	20:55:00	666	0	50.05	50.04	666.19
01/08/2015	20:50:00	666	0	50.05	50.04	666.09
01/08/2015	20:45:00	666	0	50	49.99	665.74
01/08/2015	20:40:00	666	0	49.95	49.94	666.23
01/08/2015	20:35:00	668	0	49.95	49.94	668.08
01/08/2015	20:30:00	670	0	49.95	49.94	669.81
01/08/2015	20:25:00	670	0	49.95	49.94	669.97
01/08/2015	20:20:00	670	0	49.95	49.94	670.66
01/08/2015	20:15:00	670	0	49.95	49.94	670.74
01/08/2015	20:10:00	670	0	49.95	49.94	669.93
01/08/2015	20:05:00	670	0	49.95	49.94	669.43
01/08/2015	20:00:00	670	0	49.95	49.94	670.4
01/08/2015	19:55:00	670	0	49.95	49.94	670.66
01/08/2015	19:50:00	670	0	49.95	49.99	670.28

01/08/2015	19:45:00	670	0	49.95	49.93	669.3
01/08/2015	19:40:00	670	0	49.9	49.81	669.89
01/08/2015	19:35:00	670	0	49.85	49.81	670.71
01/08/2015	19:30:00	670	0	49.85	49.87	669.84
01/08/2015	19:25:00	668.08	0	49.85	49.92	668.24
01/08/2015	19:20:00	663.03	0	49.9	49.97	662.65
01/08/2015	19:15:00	655	0	49.95	50.02	654.43
01/08/2015	19:10:00	642.5	0	50	50.02	639.06
01/08/2015	19:05:00	624.64	0	50.05	50.02	619.98
01/08/2015	19:00:00	610.1	0	50.05	50.02	606.68
01/08/2015	18:55:00	605	0	50.05	50.02	605.4
01/08/2015	18:50:00	610	0	50.05	50.02	610.52
01/08/2015	18:45:00	615	0	50	50.02	615.67
01/08/2015	18:40:00	615	0	49.95	50.02	614.15
01/08/2015	18:35:00	610	0	50	50.07	608.4
01/08/2015	18:30:00	605	0	50.05	50.12	605.45
01/08/2015	18:25:00	605	0	50.05	50.12	604.62
01/08/2015	18:20:00	605	0	50.05	50.12	604.69
01/08/2015	18:15:00	605	0	50.1	50.12	605.05
01/08/2015	18:10:00	605	0	50.15	50.12	605.13
01/08/2015	18:05:00	605	0	50.15	50.12	604.55
02/08/2015	07:20:00	620	0	49.95	49.94	620.27
02/08/2015	07:15:00	620	0	49.95	49.99	620.21
02/08/2015	07:10:00	620	0	49.95	50.04	619.59
02/08/2015	07:05:00	620	0	50	50.04	619.59
02/08/2015	07:00:00	620	0	50.05	50.04	620.94
02/08/2015	06:55:00	620	0	50.05	50.04	621.73
02/08/2015	06:50:00	620	0	50.05	50.04	619.23
02/08/2015	06:45:00	612.56	0	50	50.04	609
02/08/2015	06:40:00	602.53	0	49.95	50.04	600.13
02/08/2015	06:35:00	604.17	0	50	50.04	607.27
02/08/2015	06:30:00	614.2	0	50.05	50.04	617.19
02/08/2015	06:25:00	620.23	0	50.05	50.04	621.07
02/08/2015	06:20:00	620.56	0	50.05	50.04	617.11
02/08/2015	06:15:00	611.17	0	50.05	50.04	610.57
02/08/2015	06:10:00	607.66	0	50.1	50.04	605.28
02/08/2015	06:05:00	597.63	0	50.15	50.04	594.26
02/08/2015	06:00:00	590	0	50.1	50.04	590.07
02/08/2015	05:55:00	590	0	50.05	50.04	589.25
02/08/2015	05:50:00	590	0	50.05	50.04	590.35
02/08/2015	05:45:00	590	0	50.05	50.04	590.64

02/08/2015	05:40:00	590	0	50.05	50.04	590.53
02/08/2015	05:35:00	590	0	50.05	50.04	589.48
02/08/2015	05:30:00	590	0	50.05	50.04	590.19
02/08/2015	05:25:00	590	0	50.05	50.04	590.29
02/08/2015	05:20:00	590	0	50	50.04	590.36
02/08/2015	05:15:00	590	0	50	50.04	589.23
02/08/2015	05:10:00	590	0	50.05	50.04	590.56
02/08/2015	05:05:00	598	0	50.05	50.04	600.11
02/08/2015	05:00:00	608.03	0	50.05	50.04	609.38
02/08/2015	04:55:00	616.14	0	50.05	50.04	618.31
02/08/2015	04:50:00	626.17	0	50.05	50.04	628.75
02/08/2015	04:45:00	634.37	0	50.05	50.04	634.13
02/08/2015	04:40:00	639.4	0	50.02	50.04	639.98
02/08/2015	04:35:00	640	0	50.05	50.04	640.27
02/08/2015	04:30:00	645	0	50	49.98	645.68
02/08/2015	04:25:00	652.74	0	49.95	49.93	654.74
02/08/2015	04:20:00	662.77	0	49.95	49.93	664.3
02/08/2015	04:15:00	670	0	49.95	50	670.26
02/08/2015	04:10:00	670	0	50	50.08	671.02
02/08/2015	04:05:00	670	0	50.05	50.08	669.78
02/08/2015	04:00:00	670	0	50.05	50.08	669.78
02/08/2015	03:55:00	670	0	50.05	50.08	669.78
02/08/2015	03:50:00	670	0	50.05	50.08	670.23
02/08/2015	03:45:00	670	0	50.05	50.08	669.78
02/08/2015	03:40:00	670	0	50.05	50.08	669.78
02/08/2015	03:35:00	670	0	50.05	50.08	670.25
02/08/2015	03:30:00	670	0	50.05	50.08	669.81
02/08/2015	03:25:00	670	0	50.05	50.08	669.81
02/08/2015	03:20:00	670	0	50.05	50.08	670.32
02/08/2015	03:15:00	670	0	50.05	50.08	670.27
02/08/2015	03:10:00	670	0	50.1	50.08	669.7
02/08/2015	03:05:00	670	0	50.15	50.08	670.06
02/08/2015	03:00:00	670	0	50.1	50.08	669.76
02/08/2015	02:55:00	670	0	50.05	50.08	670.22
02/08/2015	02:50:00	670	0	50.05	50.08	669.63
02/08/2015	02:45:00	670	0	50.05	50.08	670.22
02/08/2015	02:40:00	670	0	50.05	50.08	669.76
02/08/2015	02:35:00	670	0	50.05	50.08	669.58
02/08/2015	02:30:00	670	0	50.05	50.08	669.84
02/08/2015	02:25:00	670	0	50.05	50.08	670.23
02/08/2015	02:20:00	670	0	50.05	50.08	669.49

02/08/2015	02:15:00	670	0	50.05	50.08	669.2
02/08/2015	02:10:00	670	0	50.05	50.08	670.68
02/08/2015	02:05:00	670	0	50.05	50.08	670.6
02/08/2015	02:00:00	666.1	0	50.05	50.08	663.68
02/08/2015	01:55:00	656.07	0	50.05	50.08	652.68
02/08/2015	01:50:00	654.97	0	50.05	50.08	656.89
02/08/2015	01:45:00	660	0	50.05	50.08	659.8
02/08/2015	01:40:00	660.77	0	50.05	50.08	661.32
02/08/2015	01:35:00	663.8	0	50.05	50.08	665.87
02/08/2015	01:30:00	666	0	50.05	50.08	666.42
02/08/2015	01:25:00	666	0	50.05	50.08	665.79
02/08/2015	01:20:00	666	0	50.05	50.08	665.68
02/08/2015	01:15:00	666	0	50.05	50.08	665.89
02/08/2015	01:10:00	666	0	50	50.08	666.49
02/08/2015	01:05:00	666	0	50	50.08	665.66
02/08/2015	01:00:00	666	0	50.05	50.02	665.66
02/08/2015	00:55:00	666	0	50	49.97	666.02
02/08/2015	00:50:00	666	0	49.95	49.97	665.98
02/08/2015	00:45:00	666	0	50	50.02	666.13
02/08/2015	14:00:00	649.62	0	50.01	50.06	649.57
02/08/2015	13:55:00	650	0	49.96	50.06	650.32
02/08/2015	13:50:00	650	0	49.96	50.06	650.91
02/08/2015	13:45:00	650	0	49.96	50.06	649.56
02/08/2015	13:40:00	645	0	49.96	50.06	640.97
02/08/2015	13:35:00	635	0	50.01	50.06	631.6
02/08/2015	13:30:00	635	0	50.06	50.06	635.27
02/08/2015	13:25:00	640	0	50.06	50.06	640.59
02/08/2015	13:20:00	640	0	50.06	50.06	639.78
02/08/2015	13:15:00	640	0	50.06	50.06	638.49
02/08/2015	13:10:00	643.12	0	50.06	50.06	643.68
02/08/2015	13:05:00	653.12	0	50.06	50.06	656.39
02/08/2015	13:00:00	660	0	50.06	50.06	660.14
02/08/2015	12:55:00	660	0	50.01	50.06	660.02
02/08/2015	12:50:00	660	0	49.95	50.06	660.12
02/08/2015	12:45:00	660	0	49.95	50.06	661.12
02/08/2015	12:40:00	665	0	49.95	50.06	663.73
02/08/2015	12:35:00	664.59	0	49.95	50.06	661.42
02/08/2015	12:30:00	657.58	0	50	50	659.81
02/08/2015	12:25:00	661	0	50.05	49.94	664.98
02/08/2015	12:20:00	664.79	0	50	49.94	663.06
02/08/2015	12:15:00	661.79	0	49.95	50.01	658.84

02/08/2015	12:10:00	660	0	50	50.08	657.97
02/08/2015	12:05:00	660	0	50.05	50.08	661.83
02/08/2015	12:00:00	656.67	0	50.05	50.08	655.72
02/08/2015	11:55:00	646.65	0	50.05	50.08	645.51
02/08/2015	11:50:00	640	0	50.05	50.08	640.01
02/08/2015	11:45:00	640	0	50.05	50.08	639.99
02/08/2015	11:40:00	640	0	50.05	50.08	640.06
02/08/2015	11:35:00	640	0	50.05	50.08	640.26
02/08/2015	11:30:00	640	0	50.05	50.08	639.97
02/08/2015	11:25:00	640	0	50.05	50.08	639.24
02/08/2015	11:20:00	640	0	50.05	50.08	640.07
02/08/2015	11:15:00	640	0	50.05	50.08	640.76
02/08/2015	11:10:00	639.79	0	50.05	50.08	637.63
02/08/2015	11:05:00	634.75	0	50.05	50.08	632.06
02/08/2015	11:00:00	625.17	0	50.05	50.03	622.65
02/08/2015	10:55:00	615.47	0	50.05	49.97	610.7
02/08/2015	10:50:00	605	0	50.05	49.97	602.47
02/08/2015	10:45:00	600	0	50.05	49.97	599.71
02/08/2015	10:40:00	600	0	50.05	49.97	599.24
02/08/2015	10:35:00	602.71	0	50.05	49.97	603.66
02/08/2015	10:30:00	607.75	0	50.05	49.97	609.87
02/08/2015	10:25:00	610	0	50	49.97	611.43
02/08/2015	10:20:00	610	0	49.95	49.97	609.67
02/08/2015	10:15:00	605	0	50	50.03	603.25
02/08/2015	10:10:00	600	0	50.05	50.09	599.4
02/08/2015	10:05:00	600	0	50.05	50.09	600.8
02/08/2015	10:00:00	600	0	50.05	50.09	600.89
02/08/2015	09:55:00	600	0	50.05	50.09	599.04
02/08/2015	09:50:00	600	0	50.05	50.09	598.54
02/08/2015	09:45:00	600	0	50.05	50.09	600.29
02/08/2015	09:40:00	600	0	50.05	50.09	601.06
02/08/2015	09:35:00	600	0	50.05	50.09	600.07
02/08/2015	09:30:00	600	0	50.05	50.09	598.97
02/08/2015	09:25:00	600	0	50.05	50.09	599.31
02/08/2015	09:20:00	600	0	50	50.09	600.86
02/08/2015	09:15:00	600	0	49.95	50.09	600.09
02/08/2015	09:10:00	600	0	50	50.09	598.52
02/08/2015	09:05:00	600	0	50.05	50.09	599.57
02/08/2015	09:00:00	606.78	0	50.05	50.01	611.13
02/08/2015	08:55:00	616.79	0	50	49.94	621.41
02/08/2015	08:50:00	620	0	49.95	49.94	621.2

02/08/2015	08:45:00	620	0	49.95	49.99	618.97
02/08/2015	08:40:00	622.54	0	50	50.05	620.09
02/08/2015	08:35:00	627.54	0	50.05	50.05	631.2
02/08/2015	08:30:00	637.04	0	50.05	50.05	638.26
02/08/2015	08:25:00	629.82	0	50.05	50.05	627.89
02/08/2015	08:20:00	615.09	0	50.05	50.05	612.73
02/08/2015	08:15:00	599.48	0	50.05	50.05	595.99
02/08/2015	08:10:00	590	0	50.05	50.05	589.01
02/08/2015	08:05:00	590.5	0	50.05	50.05	592.54
02/08/2015	08:00:00	598.04	0	50.05	50.05	601.12
02/08/2015	07:55:00	604.78	0	50.05	50.05	609.32
02/08/2015	07:50:00	614.97	0	50.05	50.05	617.88
02/08/2015	07:45:00	620	0	50.05	49.99	618.62
02/08/2015	07:40:00	619.57	0	50.05	49.94	619.93
02/08/2015	07:35:00	618	0	50	49.94	620.28
02/08/2015	07:30:00	620	0	49.95	49.94	619.23
02/08/2015	07:25:00	620	0	49.95	49.94	619.17
02/08/2015	20:40:00	670	0	49.95	49.96	670.35
02/08/2015	20:35:00	670	0	49.95	49.96	670.01
02/08/2015	20:30:00	670	0	49.95	49.96	670.29
02/08/2015	20:25:00	670	0	49.95	49.96	670.32
02/08/2015	20:20:00	670	0	49.95	49.96	670.33
02/08/2015	20:15:00	670	0	49.95	49.96	670.33
02/08/2015	20:10:00	670	0	49.95	49.96	670.64
02/08/2015	20:05:00	670	0	49.95	49.96	670.08
02/08/2015	20:00:00	670	0	49.9	49.96	669.83
02/08/2015	19:55:00	670	0	49.85	49.96	669.98
02/08/2015	19:50:00	669	0	49.85	49.96	668.45
02/08/2015	19:45:00	667	0	49.9	49.96	666.74
02/08/2015	19:40:00	665.5	0	49.96	49.96	665.11
02/08/2015	19:35:00	665	0	49.96	49.96	663.55
02/08/2015	19:30:00	665	0	49.96	49.91	665.89
02/08/2015	19:25:00	662.5	0	49.96	49.86	663.28
02/08/2015	19:20:00	663.5	0	49.96	49.86	665.11
02/08/2015	19:15:00	666	0	49.9	49.94	665.54
02/08/2015	19:10:00	665	0	49.96	50.02	665.54
02/08/2015	19:05:00	660	0	50.06	50.02	657.23
02/08/2015	19:00:00	647.52	0	50.06	50.02	647.43
02/08/2015	18:55:00	638.34	0	50.06	50.02	634.53
02/08/2015	18:50:00	610.5	0	50.06	50.02	610.06
02/08/2015	18:45:00	570.47	0	50.01	50.02	567.59



02/08/2015	18:40:00	531.38	0	50.01	50.02	528.97
02/08/2015	18:35:00	522	0	50.06	50.02	520.21
02/08/2015	18:30:00	520	0	50.06	50.02	519.83
02/08/2015	18:25:00	520.08	0	50.06	50.02	524.54
02/08/2015	18:20:00	532.6	0	50.01	50.02	535.89
02/08/2015	18:15:00	531.26	0	50.01	50.08	527.72
02/08/2015	18:10:00	520	0	50.11	50.13	519.22
02/08/2015	18:05:00	520	0	50.16	50.13	520.6
02/08/2015	18:00:00	525	0	50.11	50.08	526.38
02/08/2015	17:55:00	526.92	0	50.06	50.03	525.9
02/08/2015	17:50:00	521.92	0	50.06	50.03	519.99
02/08/2015	17:45:00	515	0	50.06	50.03	513.5
02/08/2015	17:40:00	510	0	50.11	50.03	510.41
02/08/2015	17:35:00	510	0	50.11	50.03	509.58
02/08/2015	17:30:00	505.04	0	50.06	50.09	504.38
02/08/2015	17:25:00	500	0	50.06	50.15	499.91
02/08/2015	17:20:00	504.96	0	50.06	50.15	504.53
02/08/2015	17:15:00	510	0	50.11	50.15	509.86
02/08/2015	17:10:00	519.49	0	50.16	50.15	521.91
02/08/2015	17:05:00	538.25	0	50.16	50.1	542.64
02/08/2015	17:00:00	557.83	0	50.11	50.05	561.38
02/08/2015	16:55:00	569.08	0	50.06	50.05	570.28
02/08/2015	16:50:00	565.54	0	50.06	50.05	564.18
02/08/2015	16:45:00	555.96	0	50.06	50.12	554.26
02/08/2015	16:40:00	550.42	0	50.11	50.2	549.67
02/08/2015	16:35:00	555	0	50.16	50.2	556.88
02/08/2015	16:30:00	560	0	50.16	50.13	560.07
02/08/2015	16:25:00	560	0	50.16	50.06	560.16
02/08/2015	16:20:00	560	0	50.16	50.06	559.67
02/08/2015	16:15:00	560	0	50.16	50.06	560.59
02/08/2015	16:10:00	560	0	50.16	50.06	559.41
02/08/2015	16:05:00	560	0	50.16	50.06	559.53
02/08/2015	16:00:00	560	0	50.11	50.06	559.21
02/08/2015	15:55:00	560	0	50.06	50.06	559.92
02/08/2015	15:50:00	559.64	0	50.06	50.06	562.38
02/08/2015	15:45:00	565	0	50.06	50.06	564.66
02/08/2015	15:40:00	564.19	0	50.06	50.06	565.63
02/08/2015	15:35:00	575	0	50.06	50.06	576.14
02/08/2015	15:30:00	580	0	50.06	50.06	581.37
02/08/2015	15:25:00	590	0	50.06	50.06	590.86
02/08/2015	15:20:00	600.42	0	50.06	50.06	602.02

02/08/2015	15:15:00	610.45	0	50.11	50.06	615.43
02/08/2015	15:10:00	631.57	0	50.16	50.06	636.05
02/08/2015	15:05:00	646.58	0	50.16	50.06	650.28
02/08/2015	15:00:00	655	0	50.11	50.06	657.72
02/08/2015	14:55:00	660	0	50.06	50.06	659.46
02/08/2015	14:50:00	660	0	50.06	50.06	659.59
02/08/2015	14:45:00	660	0	50.06	50.06	660.55
02/08/2015	14:40:00	660	0	50.06	50.06	659.2
02/08/2015	14:35:00	655	0	50.06	50.06	652.73
02/08/2015	14:30:00	650	0	50.06	50.06	650.01
02/08/2015	14:25:00	650	0	50.06	50.06	649.72
02/08/2015	14:20:00	645	0	50.06	50.06	644.98
02/08/2015	14:15:00	640	0	50.06	50.06	640.75
02/08/2015	14:10:00	640	0	50.06	50.06	640.04
02/08/2015	14:05:00	644.58	0	50.06	50.06	643.8
03/08/2015	03:20:00	660.5	0	50.05	50.02	661.2
03/08/2015	03:15:00	663.53	0	50.05	50.02	665.68
03/08/2015	03:10:00	666	0	50.05	50.02	666.19
03/08/2015	03:05:00	666	0	50.05	50.02	666.18
03/08/2015	03:00:00	666	0	50.05	50.02	666.1
03/08/2015	02:55:00	666	0	50.05	50.02	667.08
03/08/2015	02:50:00	666	0	50.05	50.02	666.63
03/08/2015	02:45:00	666	0	50.05	50.02	666.11
03/08/2015	02:40:00	666	0	50.05	50.02	665.98
03/08/2015	02:35:00	666	0	50.05	50.02	666.51
03/08/2015	02:30:00	666	0	50.05	50.02	665.64
03/08/2015	02:25:00	666	0	50	50.02	666.55
03/08/2015	02:20:00	666	0	50	50.02	666
03/08/2015	02:15:00	666	0	50.05	50.02	665.8
03/08/2015	02:10:00	666	0	50.05	50.02	666.5
03/08/2015	02:05:00	666	0	50.05	50.02	666.9
03/08/2015	02:00:00	666	0	50	50.02	665.85
03/08/2015	01:55:00	666	0	49.95	50.02	666.33
03/08/2015	01:50:00	666	0	49.95	50.02	666.18
03/08/2015	01:45:00	666	0	49.95	50.02	666.12
03/08/2015	01:40:00	666	0	49.95	50.02	666.72
03/08/2015	01:35:00	666	0	49.95	50.02	665.61
03/08/2015	01:30:00	663	0	49.95	50.02	663.71
03/08/2015	01:25:00	660	0	49.95	50.02	659.76
03/08/2015	01:20:00	660	0	50	50.02	660.15
03/08/2015	01:15:00	660	0	50.06	50.02	660.15

03/08/2015	01:10:00	660	0	50.06	50.02	659.8
03/08/2015	01:05:00	660	0	50.01	50.02	660.25
03/08/2015	01:00:00	660	0	49.95	49.97	660.14
03/08/2015	00:55:00	660	0	49.95	49.91	659.79
03/08/2015	00:50:00	661.87	0	49.95	49.91	662.33
03/08/2015	00:45:00	664.9	0	49.95	49.91	666.3
03/08/2015	00:40:00	666	0	49.95	49.91	665.63
03/08/2015	00:35:00	666	0	49.95	49.91	665.67
03/08/2015	00:30:00	666	0	49.95	49.91	665.68
03/08/2015	00:25:00	666	0	49.95	49.91	666.38
03/08/2015	00:20:00	666	0	49.9	49.91	666.7
03/08/2015	00:15:00	666	0	49.85	49.98	666.08
03/08/2015	00:10:00	662.9	0	49.85	50.05	661.53
03/08/2015	00:05:00	657.55	0	49.95	50.1	656.48
03/08/2015	00:00:00	661.7	0	50.06	50.07	664.55
02/08/2015	23:55:00	666	0	50.01	50	666.07
02/08/2015	23:50:00	666	0	49.96	50	666.22
02/08/2015	23:45:00	666	0	50.01	50.05	666.31
02/08/2015	23:40:00	666	0	50.06	50.1	666.11
02/08/2015	23:35:00	666	0	50.06	50.1	665.92
02/08/2015	23:30:00	666	0	50.06	50.03	666.46
02/08/2015	23:25:00	666	0	50.06	49.96	665.93
02/08/2015	23:20:00	666	0	50.06	49.96	665.1
02/08/2015	23:15:00	666	0	50.06	49.96	665.98
02/08/2015	23:10:00	666	0	50.01	49.96	667.74
02/08/2015	23:05:00	666	0	50.01	49.96	665.82
02/08/2015	23:00:00	662.3	0	50.06	49.96	659.34
02/08/2015	22:55:00	654.27	0	50.06	49.96	653.2
02/08/2015	22:50:00	658.1	0	50	49.96	660.67
02/08/2015	22:45:00	668.13	0	49.95	49.96	669.82
02/08/2015	22:40:00	669.89	0	49.95	49.96	668.13
02/08/2015	22:35:00	664.87	0	49.95	49.96	662.99
02/08/2015	22:30:00	660	0	50	49.96	659.95
02/08/2015	22:25:00	660	0	50.05	49.96	660.15
02/08/2015	22:20:00	660	0	50.05	49.96	660.1
02/08/2015	22:15:00	660	0	50.05	49.96	660.11
02/08/2015	22:10:00	660	0	50	49.96	660.04
02/08/2015	22:05:00	660	0	49.95	49.96	660.12
02/08/2015	22:00:00	660	0	50	49.96	659.83
02/08/2015	21:55:00	658.19	0	50.05	49.96	660.75
02/08/2015	21:50:00	666.74	0	50.05	49.96	668.34

02/08/2015	21:45:00	670	0	50.05	49.96	669.65
02/08/2015	21:40:00	670	0	50.05	49.96	669.64
02/08/2015	21:35:00	670	0	50	49.96	670.08
02/08/2015	21:30:00	670	0	50	49.96	670.1
02/08/2015	21:25:00	670	0	50	49.96	669.94
02/08/2015	21:20:00	670	0	49.95	49.96	670.7
02/08/2015	21:15:00	670	0	49.9	49.96	670.06
02/08/2015	21:10:00	670	0	49.9	49.96	670.02
02/08/2015	21:05:00	670	0	49.95	49.96	670.07
02/08/2015	21:00:00	670	0	49.95	49.96	670.39
02/08/2015	20:55:00	670	0	49.95	49.96	670.15
02/08/2015	20:50:00	670	0	49.95	49.96	670.27
02/08/2015	20:45:00	670	0	49.95	49.96	670.07
03/08/2015	10:00:00	666.29	0	50	49.93	669
03/08/2015	09:55:00	670	0	49.95	49.86	670.27
03/08/2015	09:50:00	670	0	49.95	49.86	670.29
03/08/2015	09:45:00	670	0	49.9	49.86	670.46
03/08/2015	09:40:00	670	0	49.85	49.86	670.63
03/08/2015	09:35:00	670	0	49.85	49.86	669.5
03/08/2015	09:30:00	667.5	0	49.9	49.92	665.74
03/08/2015	09:25:00	665	0	50	49.98	664.9
03/08/2015	09:20:00	664.17	0	50.05	49.98	665.95
03/08/2015	09:15:00	670	0	50	49.98	669.53
03/08/2015	09:10:00	670	0	49.95	49.98	670.27
03/08/2015	09:05:00	670	0	49.95	49.98	670.9
03/08/2015	09:00:00	668	0	49.95	49.98	668.46
03/08/2015	08:55:00	663	0	49.95	49.98	661.09
03/08/2015	08:50:00	655	0	49.95	49.98	655.49
03/08/2015	08:45:00	650	0	49.95	49.98	649.9
03/08/2015	08:40:00	645	0	49.95	49.98	645.63
03/08/2015	08:35:00	640	0	50	49.98	640.5
03/08/2015	08:30:00	639.13	0	50.05	49.98	638.7
03/08/2015	08:25:00	629.13	0	50.05	49.98	626.56
03/08/2015	08:20:00	617.3	0	50.05	49.98	614.67
03/08/2015	08:15:00	607.28	0	50.02	50.03	604.55
03/08/2015	08:10:00	600	0	50.1	50.08	603.35
03/08/2015	08:05:00	609.41	0	50.15	50.08	610.69
03/08/2015	08:00:00	610.95	0	50.1	50.03	606.88
03/08/2015	07:55:00	601.67	0	50.05	49.98	600.25
03/08/2015	07:50:00	600	0	50	49.98	600.02
03/08/2015	07:45:00	600	0	49.95	49.98	598.79

03/08/2015	07:40:00	600	0	49.95	49.98	600.13
03/08/2015	07:35:00	605	0	49.95	49.98	607.15
03/08/2015	07:30:00	615	0	49.95	49.98	618.43
03/08/2015	07:25:00	620	0	49.95	49.98	620.1
03/08/2015	07:20:00	620	0	49.95	49.98	619.72
03/08/2015	07:15:00	620	0	49.95	49.98	620.48
03/08/2015	07:10:00	620	0	50	49.98	620.35
03/08/2015	07:05:00	620	0	50.05	49.98	619.36
03/08/2015	07:00:00	620	0	50	49.93	619.71
03/08/2015	06:55:00	620	0	49.95	49.88	620.6
03/08/2015	06:50:00	620	0	49.95	49.88	619.77
03/08/2015	06:45:00	620	0	49.95	49.88	620.3
03/08/2015	06:40:00	620	0	49.95	49.88	619.93
03/08/2015	06:35:00	619.53	0	49.95	49.88	617.75
03/08/2015	06:30:00	614.5	0	49.9	49.88	611.38
03/08/2015	06:25:00	610	0	49.85	49.88	609.16
03/08/2015	06:20:00	605.03	0	49.9	49.88	602.64
03/08/2015	06:15:00	600	0	49.95	49.95	599.61
03/08/2015	06:10:00	600	0	49.95	50.02	599.34
03/08/2015	06:05:00	600	0	50	50.02	600.63
03/08/2015	06:00:00	600	0	50.05	50.02	600.73
03/08/2015	05:55:00	600	0	50	50.02	599.06
03/08/2015	05:50:00	595.93	0	49.95	50.02	594.4
03/08/2015	05:45:00	586.75	0	49.95	50.02	587.3
03/08/2015	05:40:00	590.24	0	49.92	50.02	592.26
03/08/2015	05:35:00	595.27	0	50	50.02	598.5
03/08/2015	05:30:00	600	0	50.05	50.02	600.24
03/08/2015	05:25:00	600	0	50.05	50.02	600.09
03/08/2015	05:20:00	600	0	50.05	50.02	599.24
03/08/2015	05:15:00	600	0	50	50.02	599.1
03/08/2015	05:10:00	604.58	0	49.95	50.02	607.18
03/08/2015	05:05:00	619.21	0	49.95	50.02	623.91
03/08/2015	05:00:00	639.2	0	49.95	50.02	643.59
03/08/2015	04:55:00	649.6	0	49.95	50.02	649.9
03/08/2015	04:50:00	650	0	49.95	50.02	649.93
03/08/2015	04:45:00	650	0	49.95	50.02	649.93
03/08/2015	04:40:00	650	0	49.95	50.02	650.09
03/08/2015	04:35:00	650	0	49.95	50.02	650.19
03/08/2015	04:30:00	650	0	49.95	50.02	650.57
03/08/2015	04:25:00	650	0	49.95	50.02	649.22
03/08/2015	04:20:00	645	0	49.95	50.02	644.04

03/08/2015	04:15:00	640	0	49.95	50.02	639.84
03/08/2015	04:10:00	640	0	49.95	50.02	640.16
03/08/2015	04:05:00	643.4	0	50	50.02	644.95
03/08/2015	04:00:00	648.43	0	50.05	50.02	650.3
03/08/2015	03:55:00	650	0	50.05	50.02	649.7
03/08/2015	03:50:00	650	0	50.05	50.02	649.94
03/08/2015	03:45:00	650	0	50.05	50.02	649.94
03/08/2015	03:40:00	650	0	50.05	50.02	650.58
03/08/2015	03:35:00	650	0	50.05	50.02	651.24
03/08/2015	03:30:00	655	0	50.05	50.02	655.57
03/08/2015	03:25:00	660	0	50.05	50.02	659.76
03/08/2015	16:40:00	666	0	49.95	49.97	665.96
03/08/2015	16:35:00	666	0	50	49.97	665.27
03/08/2015	16:30:00	666	0	50	49.91	665.78
03/08/2015	16:25:00	666	0	49.9	49.85	666.65
03/08/2015	16:20:00	666	0	49.85	49.85	666.23
03/08/2015	16:15:00	663.05	0	49.85	49.95	659.98
03/08/2015	16:10:00	652.27	0	49.95	50.05	650.28
03/08/2015	16:05:00	657.04	0	50.05	49.99	660.25
03/08/2015	16:00:00	666	0	50	49.89	666
03/08/2015	15:55:00	666	0	49.9	49.84	665.9
03/08/2015	15:50:00	666	0	49.85	49.89	665.84
03/08/2015	15:45:00	666	0	49.9	49.94	666.43
03/08/2015	15:40:00	666	0	49.95	49.94	666.08
03/08/2015	15:35:00	666	0	50	49.94	666.24
03/08/2015	15:30:00	666	0	50	49.94	666.68
03/08/2015	15:25:00	666	0	49.95	49.99	666.12
03/08/2015	15:20:00	666	0	49.95	50.04	666.02
03/08/2015	15:15:00	666	0	49.95	50.04	666.07
03/08/2015	15:10:00	666	0	50	50.04	666.07
03/08/2015	15:05:00	666	0	50.05	50.04	665.76
03/08/2015	15:00:00	666	0	50	49.99	666.09
03/08/2015	14:55:00	666	0	49.95	49.94	665.76
03/08/2015	14:50:00	666	0	49.95	49.94	666.1
03/08/2015	14:45:00	666	0	49.95	49.94	665.85
03/08/2015	14:40:00	666	0	50	49.94	665.99
03/08/2015	14:35:00	666	0	50.05	49.94	666.14
03/08/2015	14:30:00	666	0	50	49.94	666.01
03/08/2015	14:25:00	666	0	49.95	49.94	665.94
03/08/2015	14:20:00	666	0	49.95	49.94	665.94
03/08/2015	14:15:00	666	0	49.95	49.94	665.85

03/08/2015	14:10:00	666	0	50	49.94	665.99
03/08/2015	14:05:00	666	0	50.05	49.94	666.48
03/08/2015	14:00:00	666	0	50.05	49.94	666.16
03/08/2015	13:55:00	666	0	50.05	49.94	666.52
03/08/2015	13:50:00	666	0	50	49.94	665.93
03/08/2015	13:45:00	666	0	49.95	49.99	665.92
03/08/2015	13:40:00	666	0	49.95	50.05	665.2
03/08/2015	13:35:00	663	0	49.95	50.05	661.34
03/08/2015	13:30:00	661.5	0	49.95	50.05	662.85
03/08/2015	13:25:00	664.54	0	49.95	50.05	666.16
03/08/2015	13:20:00	661	0	50	50.05	661.04
03/08/2015	13:15:00	656	0	50.05	50.05	656.19
03/08/2015	13:10:00	656	0	50.05	50.05	656.26
03/08/2015	13:05:00	656.73	0	50.05	50.05	655.77
03/08/2015	13:00:00	656	0	50.05	50.05	656.2
03/08/2015	12:55:00	656	0	50.05	50.05	655.79
03/08/2015	12:50:00	656	0	50.05	50.05	655.58
03/08/2015	12:45:00	656	0	50.05	50.05	655.97
03/08/2015	12:40:00	661	0	50.05	50.05	663.04
03/08/2015	12:35:00	666	0	50	50.05	666.11
03/08/2015	12:30:00	666	0	49.95	50.05	665.91
03/08/2015	12:25:00	666	0	49.95	50.05	666.31
03/08/2015	12:20:00	666	0	50	50.05	665.73
03/08/2015	12:15:00	666	0	50	50.05	665.75
03/08/2015	12:10:00	666	0	49.92	50.05	665.77
03/08/2015	12:05:00	666	0	50	50.05	666.14
03/08/2015	12:00:00	666	0	50	50	665.71
03/08/2015	11:55:00	666	0	49.95	49.95	665.93
03/08/2015	11:50:00	666	0	49.95	49.95	666.12
03/08/2015	11:45:00	666	0	49.95	50.02	666.65
03/08/2015	11:40:00	666	0	50	50.09	664.02
03/08/2015	11:35:00	661	0	50.05	50.09	658.02
03/08/2015	11:30:00	656	0	50.05	50.03	658.14
03/08/2015	11:25:00	661	0	50.05	49.97	664.93
03/08/2015	11:20:00	666	0	50	49.97	665.9
03/08/2015	11:15:00	666	0	49.95	49.97	666.14
03/08/2015	11:10:00	666	0	49.95	49.97	666.41
03/08/2015	11:05:00	666	0	49.95	49.97	665.94
03/08/2015	11:00:00	666	0	50	49.97	666.13
03/08/2015	10:55:00	666	0	50.05	49.97	666.15
03/08/2015	10:50:00	667.5	0	50	49.97	666.98

03/08/2015	10:45:00	669.54	0	49.95	49.97	669.76
03/08/2015	10:40:00	670	0	49.95	49.97	670.34
03/08/2015	10:35:00	670	0	49.95	49.97	669.54
03/08/2015	10:30:00	670	0	49.95	49.91	669.66
03/08/2015	10:25:00	670	0	49.9	49.85	670.55
03/08/2015	10:20:00	670	0	49.84	49.85	670.81
03/08/2015	10:15:00	668.21	0	49.84	49.93	666.64
03/08/2015	10:10:00	663.21	0	49.89	50	660.32
03/08/2015	10:05:00	661.29	0	50	50	661.77
03/08/2015	23:20:00	662.24	0	50.05	49.99	662.49
03/08/2015	23:15:00	662.07	0	50.05	49.99	664.69
03/08/2015	23:10:00	672.03	0	50.05	49.99	672.88
03/08/2015	23:05:00	665.9	0	50.05	49.99	665.81
03/08/2015	23:00:00	667.32	0	50.05	49.99	670.91
03/08/2015	22:55:00	662.56	0	50.05	49.99	661.64
03/08/2015	22:50:00	660	0	50.05	49.99	659.29
03/08/2015	22:45:00	660	0	50	49.94	659.96
03/08/2015	22:40:00	660	0	49.95	49.89	660.22
03/08/2015	22:35:00	660	0	49.95	49.89	660.22
03/08/2015	22:30:00	660	0	49.9	49.89	659.61
03/08/2015	22:25:00	660	0	49.85	49.89	659.7
03/08/2015	22:20:00	660	0	49.85	49.94	659.79
03/08/2015	22:15:00	660	0	49.85	49.99	660.18
03/08/2015	22:10:00	660	0	49.85	49.99	659.97
03/08/2015	22:05:00	660	0	49.9	49.99	659.88
03/08/2015	22:00:00	660	0	50	49.99	659.81
03/08/2015	21:55:00	660	0	50.05	49.99	660.13
03/08/2015	21:50:00	660	0	50	49.99	660
03/08/2015	21:45:00	660	0	49.95	49.99	659.27
03/08/2015	21:40:00	660	0	50	49.99	659.93
03/08/2015	21:35:00	665	0	50.05	49.99	664.95
03/08/2015	21:30:00	670	0	50	49.94	670.41
03/08/2015	21:25:00	670	0	49.95	49.89	669.4
03/08/2015	21:20:00	670	0	49.9	49.89	670.04
03/08/2015	21:15:00	672.5	0	49.8	49.89	673.16
03/08/2015	21:10:00	675	0	49.75	49.89	674.7
03/08/2015	21:05:00	672.5	0	49.8	49.89	670.21
03/08/2015	21:00:00	670	0	49.86	49.89	669.7
03/08/2015	20:55:00	670	0	49.86	49.89	670.19
03/08/2015	20:50:00	670	0	49.86	49.89	669.77
03/08/2015	20:45:00	668	0	49.91	49.89	668.82



03/08/2015	20:40:00	666	0	49.96	49.89	665.83
03/08/2015	20:35:00	666	0	49.96	49.89	665.71
03/08/2015	20:30:00	666	0	49.96	49.89	666.22
03/08/2015	20:25:00	668	0	49.9	49.89	667.78
03/08/2015	20:20:00	668	0	49.85	49.89	667.71
03/08/2015	20:15:00	666	0	49.85	49.89	665.94
03/08/2015	20:10:00	666	0	49.91	49.89	665.88
03/08/2015	20:05:00	666	0	49.96	49.89	665.83
03/08/2015	20:00:00	666	0	49.96	49.89	665.79
03/08/2015	19:55:00	666	0	49.96	49.89	666.09
03/08/2015	19:50:00	670.5	0	49.91	49.89	671.12
03/08/2015	19:45:00	675	0	49.85	49.83	674.7
03/08/2015	19:40:00	675	0	49.8	49.76	675.12
03/08/2015	19:35:00	675	0	49.75	49.71	674.55
03/08/2015	19:30:00	675	0	49.65	49.66	675.51
03/08/2015	19:25:00	675	0	49.6	49.66	675.52
03/08/2015	19:20:00	675	0	49.65	49.66	674.06
03/08/2015	19:15:00	672.5	0	49.65	49.76	670.47
03/08/2015	19:10:00	670	0	49.75	49.86	669.88
03/08/2015	19:05:00	670	0	49.9	49.86	670.97
03/08/2015	19:00:00	670	0	49.9	49.86	669.99
03/08/2015	18:55:00	670	0	49.85	49.81	670.43
03/08/2015	18:50:00	670	0	49.85	49.76	670.24
03/08/2015	18:45:00	670	0	49.85	49.86	672.26
03/08/2015	18:40:00	670	0	49.9	49.96	671
03/08/2015	18:35:00	670	0	50	49.96	668.46
03/08/2015	18:30:00	670	0	49.95	49.93	668.97
03/08/2015	18:25:00	670	0	49.95	49.97	670.39
03/08/2015	18:20:00	670	0	50	49.97	671.23
03/08/2015	18:15:00	670	0	49.95	49.97	670.75
03/08/2015	18:10:00	670	0	49.95	49.97	669.67
03/08/2015	18:05:00	669	0	50	49.97	667.93
03/08/2015	18:00:00	666.5	0	50	49.97	667.29
03/08/2015	17:55:00	657.67	0	49.95	49.97	658.2
03/08/2015	17:50:00	650.17	0	49.95	49.97	651.01
03/08/2015	17:45:00	658	0	49.95	49.97	660.42
03/08/2015	17:40:00	666	0	49.95	49.97	666.16
03/08/2015	17:35:00	666	0	50	49.97	665.92
03/08/2015	17:30:00	663	0	50.05	49.97	664.24
03/08/2015	17:25:00	662.5	0	50.05	49.97	662.74
03/08/2015	17:20:00	662.5	0	50.05	49.97	661.38

03/08/2015	17:15:00	651.7	0	50.05	49.97	654.24
03/08/2015	17:10:00	659.5	0	50.05	49.97	661.77
03/08/2015	17:05:00	666	0	50.05	49.97	665.73
03/08/2015	17:00:00	666	0	50	49.97	665.77
03/08/2015	16:55:00	666	0	49.95	49.97	665.77
03/08/2015	16:50:00	666	0	49.95	49.97	665.77
03/08/2015	16:45:00	666	0	49.95	49.97	665.77

It is very clear for the above report and a comparison between the UI Implemented and Non implemented unit that the operator can very much regulate that Unit Load in the given band and as per the Block Avg Frequency. It is very clear that normally once the operator gives the Set point even with the change in avg frequency most of the time it is not possible to take action and which ultimately giving an impact on the grid frequency as well as the earning of the unit.

As far as UI rates are concerned it varies as follows as per block average frequency. It is quite clear from the list that for each extra UNIT generated rate varies from 35 paise to as high as Rs 8.24 based on the block average frequency. It is quite visible from the block wise record shown above that there are quite a scope of earning more and at the same time helping grid in maintaining the frequency band as narrow as possible.

Frequency (in Hz)	UI Charge (Rs/kwh)	Frequency (in Hz)	UI Charge (Rs/kwh)
49.91	3.6556	49.72	7.6152
49.9	3.864	49.71	7.8236
49.89	4.0724	49.7	8.032
49.88	4.2808	49.69	8.2404
49.87	4.4892	50.05	0
49.86	4.6976	50.04	0.356
49.85	4.906	50.03	0.712
49.84	5.1144	50.02	1.068
49.83	5.3228	50.01	1.424
49.82	5.5312	50	1.78
49.81	5.7396	49.99	1.9884
49.8	5.948	49.98	2.1968
49.79	6.1564	49.97	2.4052
49.78	6.3648	49.96	2.6136
49.77	6.5732	49.95	2.822
49.76	6.7816	49.94	3.0304
49.75	6.99	49.93	3.2388
49.74	7.1984	49.92	3.4472
49.73	7.4068		

## Data Collection and Sampling Method

The two different running unit data has been collected for the following purpose

- I. Data are collected from a normal unit without having any logic modification for UI Correction.
- II. The samples are taken at an interval of 15 minutes, as the UI block consists of 15minutes only.
- III. Relevant data like Operator Set Point, Instantaneous Frequency, Block Average Frequency, and Actual Load are taken in the report.
- IV. The date has been selected randomly.
- V. To have a clear picture of frequency although it is not predictable, sufficient number of data ie as 288 number data from both the units ie a Unit with Implemented Unit and another having normal without UI Logic.

## Source of Data

Two running units of the same capacity ie 660MW has been used to gather the datas.

## Sample Size

One sample for each block of 15minutes,total 288 samples in three days

## Method of data Collection

Definite time interval.

## Tools and techniques of analysis

Manually analyzed.

## Chapter 4

### ANALYSIS

A properly configured and applied system when compared with a Unit where the system is yet to be applied can very well shows the difference.

#### UNIT WITH UI CORRECTION

Time	OP_SP	UI_CORRECTION	INST_FREQ	AVG_FREQ	ACT_LOAD
01/08/2015 05:45:00	660.00	4.66	50.05	50.00	665.27
01/08/2015 05:50:00	660.00	4.98	50.05	50.00	665.17
01/08/2015 05:55:00	660.00	4.98	50.05	50.00	665.10
01/08/2015 06:00:00	660.00	-0.66	50.05	50.05	660.97
01/08/2015 06:05:00	660.00	-4.98	50.05	50.10	655.01
01/08/2015 06:10:00	660.00	-4.62	50.00	50.10	654.72
01/08/2015 06:15:00	662.51	1.76	49.95	50.00	659.62

#### UNIT WITHOUT UI CORRECTION

01/08/2015 05:45:00	670.00	0.00	50.05	50.00	669.67
01/08/2015 05:50:00	670.00	0.00	50.05	50.00	670.16
01/08/2015 05:55:00	670.00	0.00	50.05	50.00	670.38
01/08/2015 06:00:00	670.00	0.00	50.05	50.05	670.32
01/08/2015 06:05:00	670.00	0.00	50.05	50.10	669.93
01/08/2015 06:10:00	670.00	0.00	50.00	50.10	669.76
01/08/2015 06:15:00	670.00	0.00	49.95	50.00	669.91

-TWO BLOCK DATA CONSIDERED FOR COMPARISOPN

As is clear for the above table that the Unit with UI has given a correction of +4.98 MW when the Block Avg Frequency was less than threshold frequency ie 50.04Hz and a correction of - 4.98MW when the Block Avg Frequency was higher than threshold frequency i.e. 50.04Hz i.e. the load varies from 655MW to 665MW when the load set point of the operator was 660MW only.

While on the other side for the same Block the load remains constant at 670MW ie operator set point even the block avg frequency varied in both the direction.

Further it is quite clear from the above tables that the many of times the Instantaneous Frequency is misleading the operators as far as average block frequency is concerned, Hence it is quite possible that taking action without the knowledge of the actual block avg frequency may lead to a wrong decision.

Taking such a small correction and that to with that perfection is normally not possible without an automated system, but these small corrections gives a considerable gain to the generation and in the grid frequency stability to a great extent.

We can further analyze the data to see that there is always a chance to optimize our load set point as the grid frequency is never constant.

## Chapter 5

### INTERPRETATION OF RESULTS

The following observations have been made by the simulation with the proposed technique. It is very much visible that the grid frequency keep varying in the range of 49.84 to 50.16Hz in the collected three days data and as there are variations in the avg block frequency means there is a scope as well as requirement of having a correction in the load control to help the grid to minimize the deviation.

By incorporating the required correction as per the capacity of the connected station it is very much possible to reduce the deviation. As the correction is based on the avg frequency of the 15min block it will be same for all the connected station and a synchronized correction of all the station at the same time will necessarily help the grid to bring back the frequency in the narrow range.

As far as Generating unit is concerned the rates as mentioned in the earlier chart is varying quite a bit on variation of the block avg frequency. As is mentioned earlier on a variation of frequency from 49.84 to 50.16 Hz the equivalent rate will go as high as Rs 5 for each single unit generated which is at least 3 to 4 times higher than the normal tariff of most of the big power generator companies.

A properly designed system will regulate the Load Set Point of the Unit based on the Block Average Frequency ie if the avg frequency of the block will be higher than the threshold frequency (say 50.04 Hz) the load set point will automatically reduced to the limit possible (a limit which is predefined by the desk operator) and vice versa.

# Corrected Screen with UI

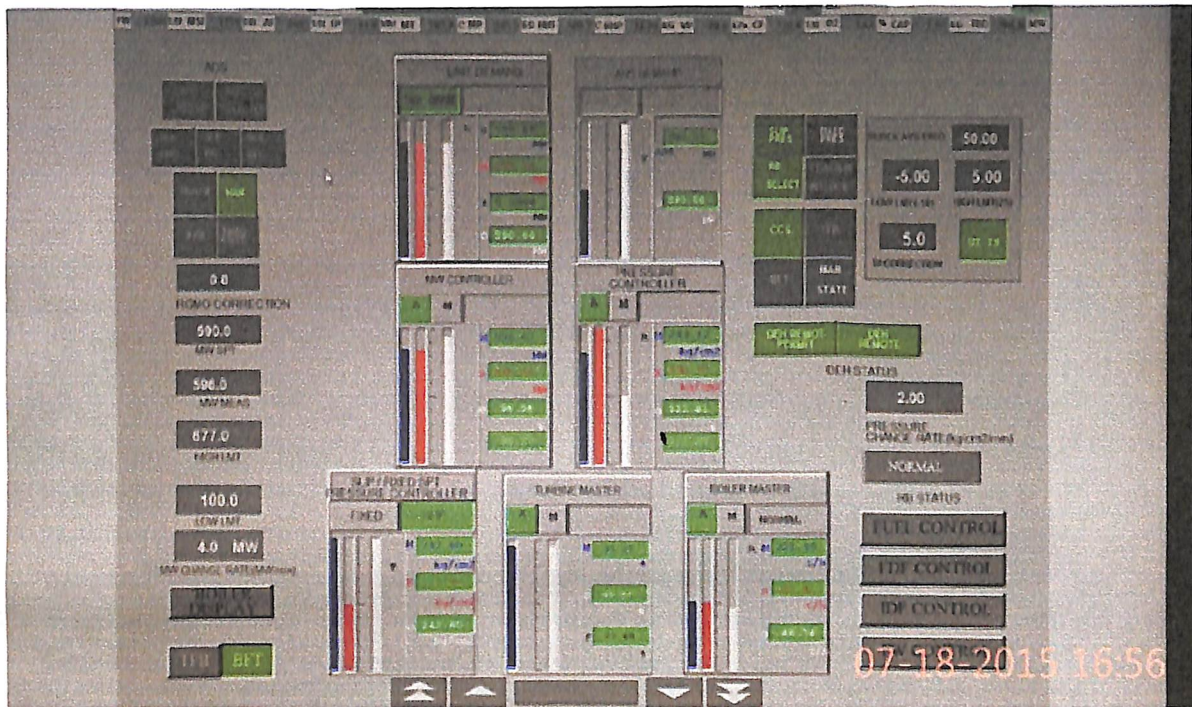

By doing this it will help the grid to maintain the frequency in the specified band and further will increase the earning of the station by feeding more when frequency is less and feeding less when frequency is high hence saving the fuel.

***“Maximization of station earning with stable grid frequency is the ultimate outcome of the study.”***

## Chapter 6

### CONCLUSION AND SCOPE FOR FUTURE WORK

The said system is very much feasible as far as implementation cost and outcome is concerned. Implementation requires necessarily the knowledge of capability and limitations of the equipment so that accordingly the system can be designed. Further technical skill to implement the system in the control system and tune accordingly to give the required result.

#### 1.1 Purpose

The purpose of the system is to maximize the earning and to reduce the loss as far as Grid Feeding Stations are concerned and availability of better quality power as far as grid is concerned.

Hence the system meets out dual purpose both for supplier and the purchaser.

#### 1.2 Economic Feasibility

As most of the resources required for successful implementation of the system are readily available in any of the running units it is very much feasible with the existing resources only. There is no need of any major investment.

#### 1.3 Technical Feasibility

Very much possible to implement with the technical skills availability in normal running units.

#### 1.4 Behavioral Feasibility

Desk Operator discipline and their attitude to maximize the earning will help the system to work better.

#### 1.5 Time Feasibility

Can be implemented in days. So very much feasible as far as implementation time is concerned.

#### 1.6 Resource Feasibility

Operation and Maintenance skills are the main resource for the said system which are quite available in the running units so is feasible from resource point of view as well.



## SCOPE OF FUTURE WORK:

Nothing is ideal, hence as far as scope and way forward is concerned which is related to the said claim are

- Implementation of the technique in max number of running and Grid Connected unit.
- Ways to improve the process so the correction load per unit can be increase atleast up to 5% of the Max Load Rating without any disturbance in the running process.
- The proposed technique has been implemented in Unit Level but the same shall be implemented with necessary correction to the station level, so that actual allowable correction can be decided at the station level and then distributed to the unit level.
- Overall gain off course can be calculated but the exact contribution due to the said system is still can be calculated.
- The claimed system has been implemented in the thermal power station ,the feasibility of the same can be studied in other types of power station as well with necessary correction.

***"A WIN- WIN SOLUTION"***

## BIBLIOGRAPHY

- [1]. Bhushan B., Roy and A. Pentayya, P., "The Indian Medicine", IEEE Power Engineering Society General Meeting 2004, Vol. 2, June 2004, pp. 2336 – 2339.
- [2]. Bhushan B., "Overcoming Power Shortage through U.I.", [www.srlc.org/Downloads/ Opstui.doc](http://www.srlc.org/Downloads/Opstui.doc)
- [3]. Chanana S. and Kumar A., "Proposal for a Real time Market based on the Indian Experience of Frequency Linked Prices", IEEE Energy 2030, Nov. 2008, pp. 1-5.
- [4]. Zhong J. and Bhattacharya K., "Frequency linked pricing as an instrument for frequency regulation in deregulated electricity markets", IEEE PES General Meeting, Toronto, Canada, July 2003, pp.566-571.
- [5]. Sood Y.R., Padhy N.P. and Gupta H.O., "Deregulated model and locational marginal pricing", Electric Power Systems research, Volume 77, Issues 5–6, April 2007, pp. 574-582
- [6]. Deshmukh, S.R., Doke, D.J. and Nerkar, Y.P., "Optimal Generation Scheduling under ABT using Forecasted Load and Frequency", Power System Technology and IEEE Power India Conference 2008, pp. 1 – 6.
- [7]. Suryanarayanan S., Farmer R. G., Heydt G. T., and S. Chakka, "Estimation of Unscheduled Flow and Contribution Factors based on Lp Norms", IEEE Transactions on Power Systems, Vol. 19, No. 2, May 2004, pp.1245-1246.
- [8]. <http://www.pserc.cornell.edu/matpower>.
- [9]. Lively M. B., "Creating an automatic market for unscheduled electricity flows", The National Regulatory Research Institute[Online] Dec. 2005, pp.1-8. Available:<http://www.livelyutility.com/library.php>.
- [10]. Soonee S.K., Narasimhan S.R. and Pandey V., Significance of unscheduled interchange mechanism in the Indian electricity supply industry," Dept. of Electrical Engineering, ITBHU, ICPSODR- 2006, [Online] Available:[http://www.nrlc.org/docs/documents/Papers/Significance\\_of\\_UI.pdf](http://www.nrlc.org/docs/documents/Papers/Significance_of_UI.pdf)
- [11]. Lively M. B., "Pricing intermittency, loop flow, and other forms of unscheduled flows of electricity," presented at *A Web Based Seminar by Leonardo ENERGY*, 2007. [Online]. Available: <http://orig.leonardo-energy.org/drupal/node/1517>.
- [12]. Lively M. B., "Profit-enhancing seam management: a white paper on pricing the unscheduled flows of electricity across the seams between utilities using a geographically differentiated auction of inadvertent interchange. Gaithersburg, MD, 2001. [Online]. Available: [http://www.naesb.org/pdf/weq\\_iiptf080603w3.pdf](http://www.naesb.org/pdf/weq_iiptf080603w3.pdf).
- [13]. Suryanarayanan S., Heydt G. T., Farmer R. G., and Chakka S., "An estimation technique to assign contribution factors for loop flows in an interconnected power system," *Electric Power Components and Systems*, vol. 32, no. 8, 2004, pp. 813–826.
- [14]. Suryanarayanan S., Heydt G. T., "Modification to contribution factor formula for unscheduled flows," *IEEE Transactions on Power Systems*, vol. 23, no. 2, May 2008, pp. 809-810.
- [15]. Suryanarayanan S., Montgomery D., and Heydt G. T., "Considerations for implementing tag schedules in transmission circuits," *IEEE Transactions on Power Systems*, vol. 20, no. 1, 2005, pp. 523–524.
- [16]. [http://powermin.nic.in/transmission/pdf/Indian\\_Electricity\\_Grid\\_Code.pdf](http://powermin.nic.in/transmission/pdf/Indian_Electricity_Grid_Code.pdf).

## APPENDIX

- UI LOGIC IMPLEMENTATION PRESENTATION

### UI CORRECTION LOGIC

#### What is UI?

- **Unscheduled Interchange (UI)** is the mechanism developed to improve grid efficiency, grid discipline, accountability and responsibility by imposing charges on those who defer from their scheduled generation or drawl.

#### Importance of UI

- Apart for other facts regarding UI which is applicable for both Stable Grid operation and rest of the generating units; *considering the lowest tariff of many station proper optimization of UI earning also gives an edge in the profitability of the station.*

### **Problems with traditional method**

- Dedicated operator shall workout for load change set point based on the current frequency and his wisdom.
- Predicting the frequency trend in 15min block is quite a gambling, and there is no thumb rule of it.
- Many of times it goes against where not only we loose UI earning but also get penalized.
- Instantaneous Frequency measurement and the block average frequency misguide to take call.
- Too many variation in freq and the corresponding load set point variation may not be feasible due to limitation of boiler response.
- For the same variation the corrections are different from man to man or unit to unit.

3

### **Solution**

- Considering the above facts it is very clear that there is a need of optimizing the system to maximize the earning and minimize the loss that too consistently.
- A logic has been made in view of the above issues which can address as many as possible.

### **Permissive for putting in the Auto correction IN**

- CCS should be IN.
- No Runback
- Operator shall "Put In" the correction manually.

4



### Description of different component

- ⊙ Block Timer: A timer has been designed which is sync with GPS time to track the Block Time.
- ⊙ Instantaneous Frequency: To reduce the measuring transducer error and lag, Average Turbine Speed of all running unit has been taken to calculate the Instantaneous Frequency.
- ⊙ Average Frequency: Block Average frequency has been calculated with the above Inst frequency with a sampling rate of 5 sec /sample.

5



### Description of Control

- ⊙ Average Frequency of the Block is the measured variable of a PID having a set point of Breakthrough Frequency ie 50.04Hz.
- ⊙ Based on the Higher Limit and Lower Limit Correction if the Average Frequency changes the MW Correction is being added/subtracted from the existing set point.
- ⊙ The set point after correction can not be more than the entered High Limit of the Unit.
- ⊙ At any time of block the operator can put the logic in line i.e. the logic keeps tracking the average freq and time in the background even though it is not selected by operator.

6



## Fine Tuning

- To avoid the immediate fluctuation and better stability during the Block changeover, the correction has been blocked for five min if the new block freq in the band of 50.02 and 50.06 Hz.
- Further at times the frequency hunts quite a lot i.e. varies from 49.8 to 50.10 and that too in very short interval of time, hence a lead lag block has been used to check out if the rate of increase/decrease is more then it will not give the correction.

7



## Result

- Logic has been tested and implemented in one of the running unit and is running fine.

### Way Forward and Limitations

- DCS time should be correctly synchronized with GPS.
- May be implemented in other units as well.

8

# Flow chart

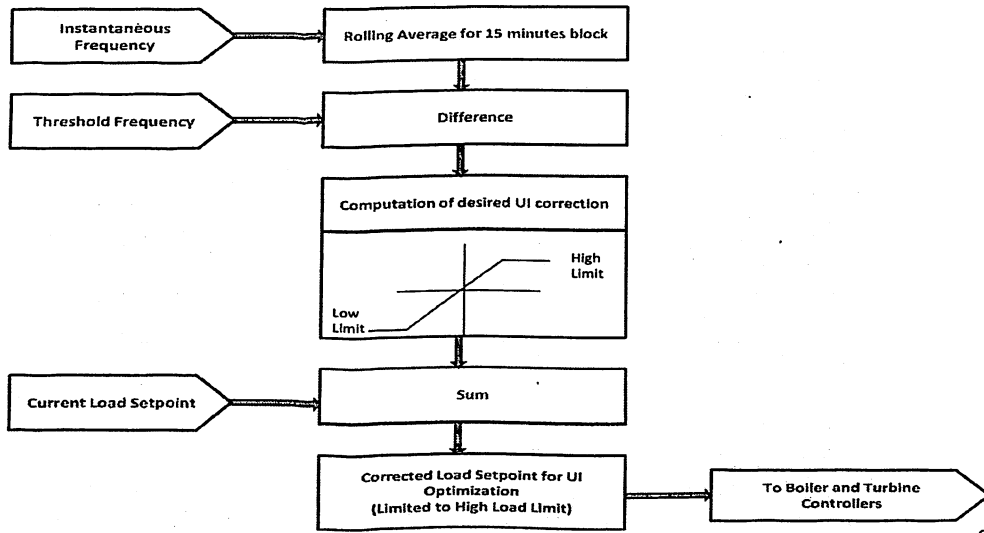

9

## INSTANTANEOUS FREQUENCY CALCULATION

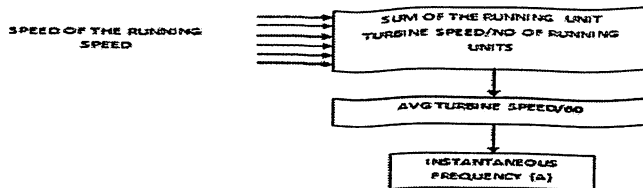

## AVERAGE BLOCK FREQUENCY CALCULATION

$$\text{AVG BLOCK FREQ (F}_{\text{avg}}) = F/N$$

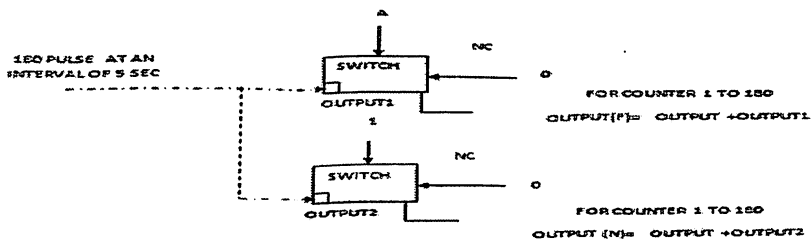

10

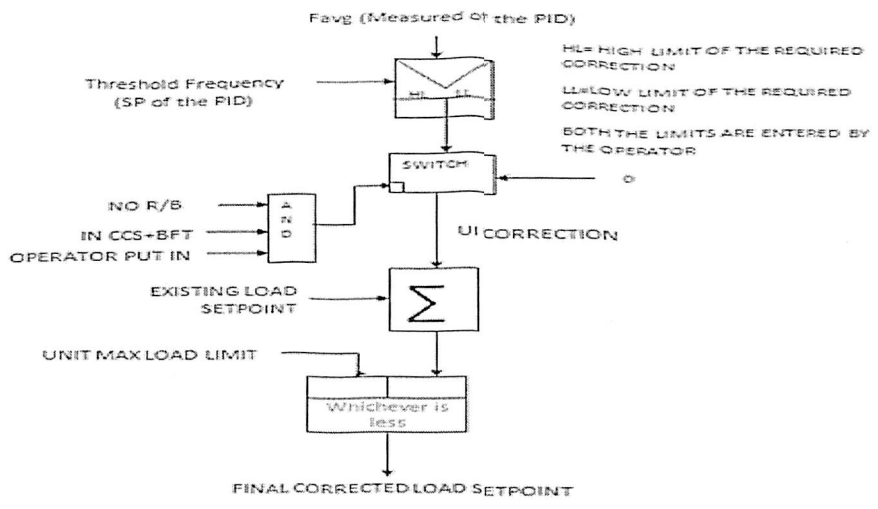

# Corrected Screen with UI

