

# **METRO TRAINS – SMART GRID ON THE MOVE**

**A Project Report**

**Submitted by**

**K. Thangaraj (R124214009)**

*In partial fulfillment of the requirements*

*For the award of degree in*

**Master of Technology**

In

Power Distribution with Specialization in Smart Grids

Under the guidance of

Mr. Ponram

Manager – Testing and Commissioning

ALSTOM Transport India Limited



**DEPARTMENT OF ELECTRICAL POWER AND ENERGY**

**COLLEGE OF ENGINEERING STUDIES**

**UNIVERSITY OF PETROLEUM AND ENERGY STUDIES**

Bidholi Campus, Energy Acres

Dehradun - 248007

**April – 2016**

## **DECLARATION BY THE SCHOLAR**

I hereby declare that this submission is my own and that, to the best of my knowledge and belief, it contains no material previously published or written by another, nor material which has been accepted for the award for any other Degree or Diploma of the University or other Institute of Higher Learning, except where due acknowledgement has been made

K. Thangaraj (R124214009)

## CERTIFICATE

This is to certify that the thesis titled ***METRO TRAINS – SMART GRID ON THE MOVE*** submitted by ***K. THANGARAJ (R124214009)***, to the University of Petroleum & Energy Studies, for the award Of the degree of ***MASTER OF TECHNOLOGY*** in ***POWER DISTRIBUTION WITH SPECIALIZATION IN SMART GRIDS*** is a bonafide record of project work carried out by him/her/them under my/our supervision and guidance. The content of the thesis, in full or parts have not been submitted to any other Institute or University for the award of any other degree or diploma.



Mr. Ponram. K  
Manager – Testing and Commissioning  
ALSTOM Transport India Limited

Date: \_\_\_\_\_

## **ACKNOWLEDGEMENTS**

I would like to thank my *Head of the Department, Dept of Electrical Power and Energy - Mr. N.B. Soni* for encouraging me to take up the project work and complete it, also I would like to extend my thanks to *Mr. K.S. Sajan - Course Coordinator, M. Tech – Power Distribution with Specialization in Smart Grids* for supporting me in the project in all aspects.

I also like to extend my sincere gratitude to *ALSTOM Transport India Limited* for providing me an opportunity to work with a real time project and I thank *Mr. Ponram – Manager (Testing and Commissioning)* for helping me to execute the project under his guidance, *Mr. Sargunan (Train Manager)* for making me understand the different testing that is done on a train, *Mr. V.J.S.S Sharma (Testing Engineer)* for taking effort to making me to complete the project in the domain on Dynamic and Interface Testing.

## **ABSTRACT**

Modern day metro trains are completely equipped with systems and technologies that are highly advanced. Every sub-systems of a metro train and the entire metro project operation as a whole has electrical, telecommunication, signaling and mechanical systems. All the above mentioned together forms a successful metro project, and if any of the mentioned systems is not integrated properly the entire project is a failure. This project takes into account the base line definition of Smart Grid and proceeds to prove that the metro trains indeed are smart grid, except that it is mobile. The entire approach is based on a practical means i.e. testing and commissioning which gives a clear idea about the systems on board and their integrity.

# CONTENTS

<b>DECLARATION BY THE SCHOLAR</b> .....	i
<b>CERTIFICATE</b> .....	ii
<b>ACKNOWLEDGEMENTS</b> .....	iii
<b>ABSTRACT</b> .....	iv
<b>NOMENCLATURE</b> .....	1
<b>Chapter – 1: INTRODUCTION</b> .....	3
<b>1.1 Introduction to Chennai Metro Rail Project</b> .....	3
<b>1.1.1 Sub-Urban Sections</b> .....	3
<b>1.1.2 MRTS System</b> .....	3
<b>1.2 Details and Features of Chennai Metro Rail Project</b> .....	4
<b>1.3 Project Organization and Project Scope of ALSTOM</b> .....	5
<b>1.3.1 Project Organization</b> .....	5
<b>1.3.2 Project Scope of ALSTOM</b> .....	5
<b>Chapter – 2: LITERATURE REVIEW</b> .....	7
<b>2.1 Traction Power Supply and Rolling Stock Basics</b> .....	7
<b>2.1.1 Traction Power Supply Overview</b> .....	7
<b>2.2 Rolling Stock</b> .....	11
<b>2.3 Rolling Stock Operation Basics</b> .....	12
<b>2.4 Rolling Stock Power Flow</b> .....	14
<b>2.5 Neutral Section Detection in Rolling Stock</b> .....	14
<b>2.5.1 Operation of Neutral Detection</b> .....	14
<b>2.6 Return Current Path</b> .....	15
<b>2.7 Why single phase and Why not three phase?</b> .....	15
<b>Chapter – 3: Materials and Methodology</b> .....	16
<b>3.1 Testing and Commissioning of Rolling Stock</b> .....	16
<b>3.2 Train Wakeup Procedure</b> .....	23
<b>3.3 Non-Regression Testing (NRT)</b> .....	23
<b>3.4 Non – Regressive Testing (NRT)</b> .....	29
<b>3.4.1 Train Wakeup</b> .....	29
<b>3.4.2 Miscellaneous Body Checks (leveling)</b> .....	29
<b>3.4.3 Passenger Announcement and Passenger Information Systems (PA-PIS)</b> .....	32
<b>3.4.4 Brake Test</b> .....	36

3.4.5 Pneumatic Tightness Test.....	40
3.4.6 Lighting Test.....	41
3.4.7 Doors Test .....	42
3.4.8 Return Current Test .....	44
3.4.9 Vehicle Networks Test .....	45
3.5 Routine Dynamic Test (RDT) .....	47
3.5.1 Brake Preliminary Verification .....	47
3.5.2 Pneumatic Service Brake Test .....	49
3.5.3 Emergency Brake Test.....	51
3.5.4 Back up Brake Test.....	52
3.5.5 Train to Train tow Test .....	53
3.6 Interface Test / Joint Test.....	54
Chapter – 4: Results and Discussions.....	58
4.1 Recommendations for the Chennai Metro System .....	58
4.1.1 Ventilation and Air Conditioning Unit (VAC) .....	58
4.1.2 Single Point Data Collection.....	59
Chapter – 5: CONCLUSIONS.....	61
REFERENCES.....	65

## **TABLE OF FIGURES**

<b>Table 1: GIS Sub-Station .....</b>	<b>9</b>
<b>Table 2: ALSTOM – Metropolis.....</b>	<b>11</b>
<b>Table 3: Driver Cab Control Switches .....</b>	<b>16</b>
<b>Table 4: Circuit Breakers.....</b>	<b>19</b>
<b>Table 5: Relay List .....</b>	<b>21</b>
<b>Table 6: Pressure and Height Requirements.....</b>	<b>30</b>
<b>Table 7: Train Leveling Procedure .....</b>	<b>32</b>
<b>Table 8: PA-PIS System Components.....</b>	<b>33</b>
<b>Table 9: Braking Systems.....</b>	<b>41</b>
<b>Table 10: Braking Systems Verification .....</b>	<b>48</b>
<b>Table 11: Corrected Distance Measurement.....</b>	<b>50</b>
<b>Table 12: Deceleration Calculations.....</b>	<b>50</b>
<b>Table 13: Interface Testing Systems.....</b>	<b>55</b>
<b>Table 14: VAC Unit Replacement .....</b>	<b>59</b>
<b>Table 15: Electrical Systems of Metropolis .....</b>	<b>61</b>
<b>Table 16: Information and Communication Technologies.....</b>	<b>62</b>
<b>Table 17: Mechanical Systems .....</b>	<b>64</b>



## LIST OF FIGURES

<b>Figure 1: Existing MRTS and Sub-Urban Network</b> .....	3
<b>Figure 2: Chennai Metro Route Map</b> .....	7
<b>Figure 3: Traction Power Supply System</b> .....	12
<b>Figure 4: Neutral Section Detector</b> .....	14
<b>Figure 5: Software Version Screen from DDU</b> .....	24
<b>Figure 6: Propulsion Control Electronics System</b> .....	25
<b>Figure 7: Propulsion Control Electronics Software Installation</b> .....	26
<b>Figure 8: Main Processing Unit (MPU)</b> .....	27
<b>Figure 9: Event Recorder and Universal Media Controller</b> .....	27
<b>Figure 10: Driver Display Unit</b> .....	29
<b>Figure 11: Train Shutdown</b> .....	29
<b>Figure 12: Secondary Suspension</b> .....	30
<b>Figure 13: Passenger Emergency Intercom</b> .....	35
<b>Figure 14: PEI and PA-PIS Control Push-Buttons</b> .....	35
<b>Figure 15: Pre-Defined Messages in PA-PIS</b> .....	36
<b>Figure 16: Mechanical Tread Braking Unit</b> .....	37
<b>Figure 17: Disc Brake</b> .....	37
<b>Figure 18: Parking Braking Selector Switch</b> .....	38
<b>Figure 19: Backup Braking Operating Rod</b> .....	38
<b>Figure 20: Dead Man and Emergency Brake Indicators</b> .....	39
<b>Figure 21: Dead Man Time Setting Relay</b> .....	39
<b>Figure 22: Emergency Push Button</b> .....	40
<b>Figure 23: Emergency Brake in Master Controller</b> .....	40
<b>Figure 24: Door Specifications</b> .....	42
<b>Figure 25: Obstacle Detection</b> .....	43
<b>Figure 26: Emergency Egress Device</b> .....	44
<b>Figure 27: Earthing Bush</b> .....	44
<b>Figure 28: Networks Screen</b> .....	45
<b>Figure 29: Pneumatic Tightness Test Readings</b> .....	51
<b>Figure 30: Vehicle Mileage from DDU</b> .....	51
<b>Figure 31: Emergency Brake Test</b> .....	52
<b>Figure 32: Back Brake Test Results</b> .....	53
<b>Figure 33: ATO Selector Switch</b> .....	54
<b>Figure 34: Smart Grid Definition (Base Line)</b> .....	61

# Metro Trains – A Smart grid on the move



Thangaraj Kannan

## **NOMENCLATURE**

ACE	Auxiliary Control Electronics
ASIC	Auxiliary Suspension Isolation Cork
ATP	Automatic Train Protection
ATO	Automatic Train Operation
ATC	Automatic Train Control
AR	Auxiliary Reservoir
AR	Auto Reversal
BCE	Brake Control Electronics
BPIC	Brake Pressure Isolation Cork
BB	Backup Brakes
CB	Circuit Breaker
CAN	Controller Area Network
CMRL	Chennai Metro Rail Limited
BR	Brake Reservoir
DCC	Depot Control Center
DDU	Driver Display Unit
DRM	Dynamic Route Map
EDCU	Electronic Door Control Unit
EB	Emergency Brake
EVR	Event Recorder
EED	Emergency Egress Device
FSB	Full Service Brake
FD	Frontal Display
GIS	Gas Insulated Switchgear
IGBT	Insulated Gate Bipolar Transistor
ID	Internal Display
MPU	Main Processing Unit
MPIC	Main Pressure Isolation Cork
MVB	Multiple Vehicle Bus
MR	Main Reservoir
NVR	Network Video Recorder
OCC	Operation Control Center
PCE	Propulsion Control Electronics
PEI	Passenger Emergency Intercom
PBIC	Parking Brake Isolation Cork
PACIS	Passenger Announcement and Customer Information Systems
PB	Parking Brake

PAPIS	Passenger Announcement and Passenger Information System
RM	Rescue Mode
RM	Restricted Mode
TCCU	Train Communication and Control Unit
TWU	Train Wakeup Unit
TNEB	Tamil Nadu Electricity Board
TCMS	Train Control and Management System
UMC	Universal Media Controller
VAC	Ventilation and Air Conditioning

# Chapter – 1: INTRODUCTION

## 1.1 Introduction to Chennai Metro Rail Project

Chennai is the 4<sup>th</sup> largest city in India. It is a coastal city with the second largest beach in the world. It is India's major leather producing city. The city with its present population about 8 million generates 11 million trips a day, with about 6 million vehicular trips. Rapid increase in the traffic volume on the road made the necessity of new transport system, hence the rail based project for mass transportation "Chennai Metro Rail Project."

This project aims in providing faster, reliable, modern and convenient form of public transport.

Existing rail network:

All parts of Chennai are well connected by the sub-urban trains and Mass Rapid Transit System [MRTS]

### 1.1.1 Sub-Urban Sections

A. north line towards gummidipoondi

B. west line towards arakkonam

C. south line towards chengalpattu

Central to Gummidipoondi – 48km, 16 stations

Central to arakkonam - 69km, 29 stations

Beach to tambaram - 30km, 18 stations

### 1.1.2 MRTS System

North south corridor along Buckingham canal alignment from Chennai beach to Velachery. It covers a total distance of 20 Km. It is a broad gauge with double line system using 25KV AC traction with conventional EMU. The extension from Velachery to St. Thomas mount is sanctioned and is being taken up for execution.

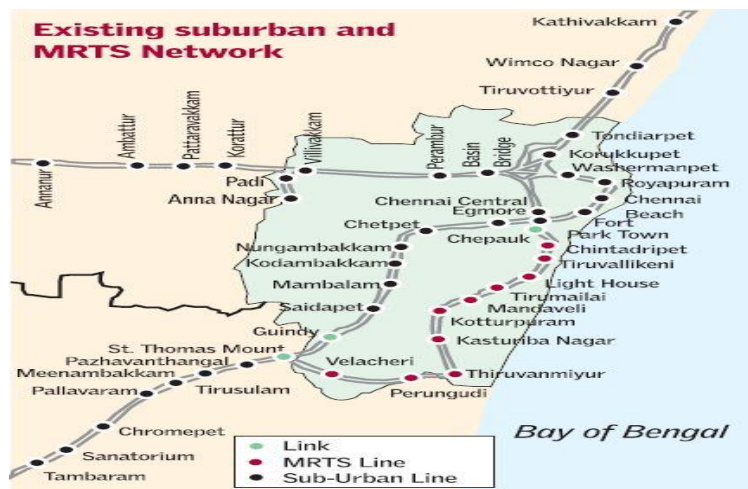

Figure 1: Existing MRTS and Sub-Urban Network

## **1.2 Details and Features of Chennai Metro Rail Project**

The features of the Chennai metro rail project are as follows:

1. Ballast less tracks
2. Automatic Fare Collection
3. Fully automated station
4. Safe and Faster to travel

The details of the Chennai metro rail project are as follows:

**1. The height of elevated viaducts in corridor 1, which includes the metro station and the train height, is restricted to 12m.**

**2. Signaling and train control:**

The signaling requirements are planned by adopting 'Distance to go' and Automatic Train Protection [ATP] and Automatic Train Supervision [ATS].

**3. Telecommunication facilities proposed are helpful in meeting the requirements for**

- a. Supplementing the signaling system for efficient train operation
- b. Exchange of managerial information
- c. Crisis management during management
- d. Passenger information system

**4. Proposed telecommunication system will cater to following requirements.**

- a. Train traffic control
- b. Assistance to train traffic control
- c. Maintenance control
- d. Emergency Control
- e. Station to station dedicated communication
- f. Passenger announcement system and passenger information and display system within station from central control to each station
- g. Centralized clock system
- h. Instant on line communication between central control and moving cars and maintenance personnel
- i. Data channels for signaling, SCADA, Automatic Fare Collection

## **1.3 Project Organization and Project Scope of ALSTOM**

### **1.3.1 Project Organization**

Given below is the organizational chart of the Chennai Metro Rail Project.

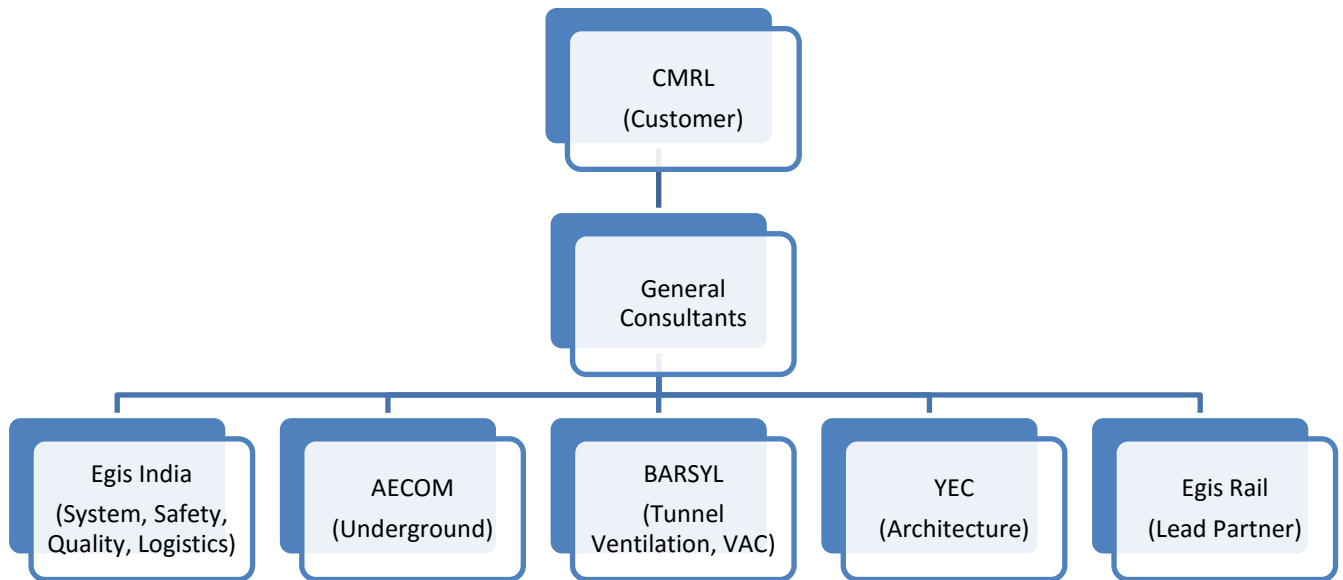

### **1.3.2 Project Scope of ALSTOM**

ALSTOM Transport India Limited is responsible for supplying the Rolling Stock for Chennai Metro Rail Project. In contract with the Chennai Metro Rail Limited (CMRL), ALSTOM has to provide a total of 168 cars for the project which 33 train sets have come to the project depot site. Some of them are assembled state whereas others are yet to be assembled and tested.

ALSTOM will provide the support for the project until all the cars are properly checked, tested and commissioned and then finally handed over to the client. The warranty of the trains will last till 2 years and the warranty period will start once the train is handed over to the client, until the time of commissioning if there are any faults or damage in the train it will be bared by ALSTOM Transport India Limited.

ALSTOM Transport India has separate teams for

1. Testing and Commissioning
2. Warranty
3. Retrofit

In the further chapters we shall see how the rolling stock receives the power from the overhead line for its operation and its different tests.



## Chapter – 2: LITERATURE REVIEW

### 2.1 Traction Power Supply and Rolling Stock Basics

#### 2.1.1 Traction Power Supply Overview

Given below diagram is the metro route for Chennai Metro Project.



Figure 2: Chennai Metro Route Map

1. The various sub-stations that are concerned with the metro project are as follows.
  - a. **Receiving Sub-Station [RSS]** – This is a sub-station that receives the necessary power for the metro from Tamil Nadu Electricity Board. This is an 110kV/33kV and 110kV/25kV substations.

In this project we have 3 sub-stations that are located in the following places.

1. **Chennai Central**
2. **Alandur**
3. **Koyambedu**

Koyambedu station has the following features

- a. **It has a shed for the rolling stock**
- b. **Test Track**
- c. **Metro Administration Office**

- b. **Traction Sub-Station [TSS]** – This is used for the purpose for providing traction. The voltage level will be stepped down from 110Kv to 25KV [Single Phase] and this will be provided to the OHE.

**1. Chennai Central**

**2. Alandur**

**3. Koyambedu**

- c. **Auxiliary Sub-Station [ASS]** – This is used for the purpose for station usage such as, lifts, escalators, lighting etc.

We have an Auxiliary Sub-station in every station.

Corridor Number	No. of Under Ground Stations	No. of Elevated Stations
1	11	6
2	8	7
<b>Total</b>	<b>19</b>	<b>13</b>

We have a total of **32 stations** and hence we have **32 Auxiliary Sub-stations**.

As mentioned above the project has 3 main receiving sub-stations (RSS) at mentioned locations. The gets its power supply from Tamil Nadu Electricity Board (TNEB) at a voltage level of 220kV, which is then stepped down to 110kV at TNEB sub-station located nearby to the CMRL sub-station. The CMRL sub-stations receive the power from TNEB at a voltage level of 110kV. This is further stepped-down to a voltage of 33kV which is used for station auxiliaries and also to 25kV which will be used for traction power supply via overhead conductors as mentioned above. The sub-station is indoor and are GIS (Gas-Insulated Switchgear) based.



There are 4 transformers at every sub-station of which 2 is 110/33kV and the other 2 transformers are 110/25kV. There are 2 in each because of the redundancy. In case one of the transformer is taken out for service maintenance then the other transformer which is in stand-by can take the load, also if the transformer which is in operation is under fault then in that case to the other transformer can take the load and hence the supply is not interrupted.

The transformers are ABB make and the switch gears which are in place for the protection of the electrical systems is designed and manufactured by SIEMENS. The metering and relay systems are L&T make.

At present the sub-station at Koyambedu is energized and is supplying for the metro operations every day. This sub-station was commissioned in July 2013. Given below are some of the pictures related to sub-station.

**Table 1: GIS Sub-Station**

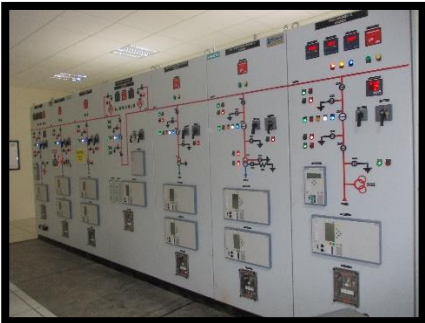
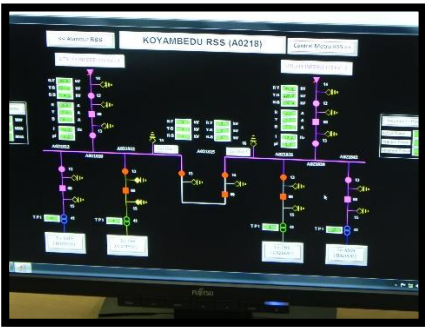
<b>Image</b>	<b>Description</b>
	<p>Tamil Nadu Electricity Board Sub-Station 220kV/110kV (GIS)</p>
	<p>Chennai Metro Rail Sub-Station Koyambedu RSS 110kV/33kV and 110kV/25kV</p>
	<p>110kV GIS Module – Rear View</p>
	<p>110kV GIS Module – Front View</p>

	<p>110kV GIS Module – Control Room View</p>
	<p>Control and Relay Panel of Koyambedu RSS</p>
	<p>SCADA Screen of Sub-Station</p>
	<p>33kV Switchgear Arrangement</p>

## **2.2 Rolling Stock**



Rolling Stock is the technical name given for the metro coaches. The rolling stock has 2 main components

1. Driver Motor Car (DMC)
2. Trailer Car (TC)

In Chennai metro rail project, the product of ALSTOM – Metropolis is a train set of 4 cars. It has 2 driver motor cars and 2 trailer cars. One set of motor car and trailer car coupled together is called as a married pair. Each car has 4 axles and hence totaling to 16 axles for 4 car train set. Every Driver Motor Car (DMC) is fitted with the traction motor and gear arrangement which helps the train to move. The trailer car doesn't have any traction motor car fitted.

Unlike the mainline engines operating for Indian railways which has only one operating cabin, the metro trains have 2 cabins from which the train can be operated and hence the necessity of 2 DMC's. Given below is the picture of the rolling stock and the driver cab.

**Table 2: ALSTOM – Metropolis**

Picture	Description
	<p><b>Front view of the rolling stock ALSTOM – Metropolis</b></p>
	<p><b>Side view of the rolling stock</b></p>



### Driver Cab Control of the Rolling Stock

The entire length of the rolling stock is around 94m and the controls of the entire train are state of the art. Every car has different sensors for various different purposes and control. From the above table-2 picture 3 we can find various controls for the train operation.

1. The screens that are present in the left and right side are the SCADA screens from which we can find out the status of the sensors, instrumentation and control systems of the train.
2. The center panel is the HMI of the train which displays the speed of the train and other information such as voltage
3. There are several buttons on the left and right side, which are used for the operation of doors, lights, HVAC, brakes, whistle and horn.
4. There is an operating rod on the left side which is used for filling up the backup pressure tanks.

### 2.3 Rolling Stock Operation Basics

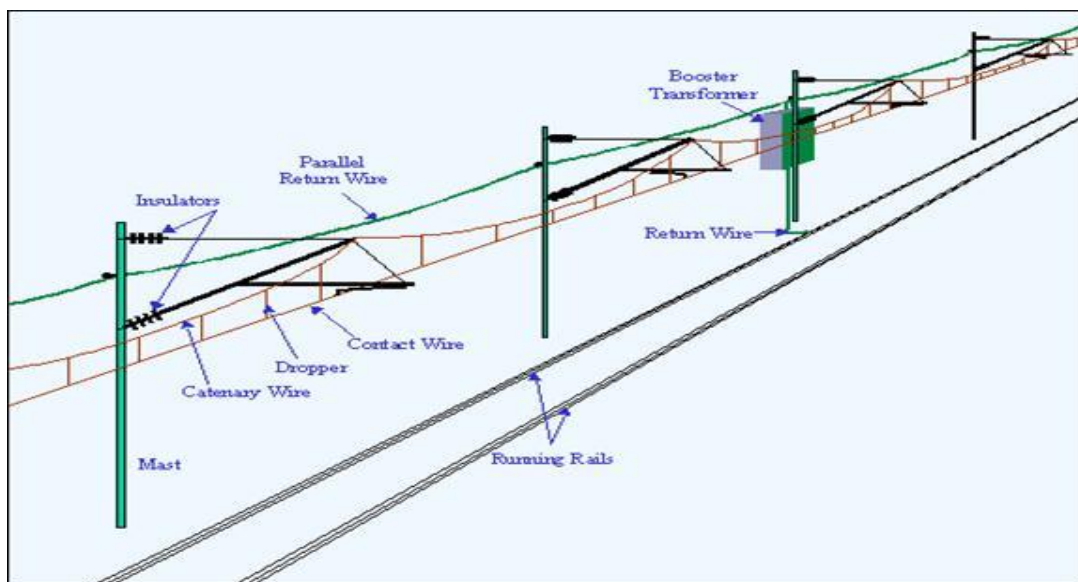

**Figure 3: Traction Power Supply System**

The various components of an Overhead Transmission are as follows.

1. OHE mast
2. Catenary System
3. Pantograph
4. Stagger
5. Insulator
6. Booster Transformer

### **1. OHE mast**

This is the supporting structure through which the overhead cable is run along the distance by placing it in between at some frequent distances.

### **2. Catenary System**

This consists of the messenger wire and the current carrying wire.

From the current carrying wire the rolling stock gets the power supply for its operation.

To achieve good high-speed current collection, it is necessary to keep the contact wire geometry within defined limits. This is usually achieved by supporting the contact wire from above by a second wire known as the messenger wire.

### **3. Pantograph**

This is a device that is present on the roof of the rolling stock that actually comes in contact with the current carrying cable. It consists of carbon brushes which are used for current collection, and this is converted to a 3 phase supply which feeds the traction motor.

### **4. Stagger**

This is an arrangement made in the OHE mast; it consists of a moving arm which actually adjusts the contact wire that is touching the pantograph. We have carbon brushes in the pantograph, when the rolling stock is in motion in a straight line for a long time; there are chances that the carbon brushes get grooved. Hence an adjustment is made so that the contact point doesn't touch just only one point, rather it is made to move in horizontal direction in left and right direction.

### **5. Booster Transformer (Optional Design)**

This is a 1:1 ratio transformer which is used for isolation purpose.

Any overhead traction system contains the above components. With the help of these components the rolling stock gets the power for its tractive effort to overcome the adhesion between the rail and the wheel. Adhesion is nothing but the friction that exists between the rail and the wheel, higher the friction better the motion, lower the friction then the chances of wheels

getting slipped is higher. The chances of slipping of wheels are more in case of steam traction, in diesel it is about 45% and in electric traction it is about 52% to 55%. Hence the motion is better.

## **2.4 Rolling Stock Power Flow**

The rolling stock gets its power from the pantograph that is constantly in touch with the overhead supply line. Since the pantograph has carbon brushes it collects the single phase current from it, then it is passed through a transformer which increases or decreases the voltage level as per the needs. This single phase supply is then fed to a rectifier circuit which converts the Alternating Current to a Direct Current Source, then this is fed to an inverter circuit which converts it to a three phase source and this three phase source is fed to the 3 phase traction motor. Now the motor starts to rotate, hence to control the speed we use a gear arrangement. This arrangement is mounted in the axle of the rolling stock and the wheels in turn are connected to the axle. The body of rolling stock is placed over the chassis which hoists the axle and other parts; hence the motion of the rolling stock is achieved.

## **2.5 Neutral Section Detection in Rolling Stock**

Another important feature that is present in all the metro power supply design is that the presence of neutral section. This section is provided when there is a phase change happening. For example, in Chennai Metro Rail project, there are 3 sub-stations as mentioned in the above location, and these 3 sub-stations will feed the entire length of the metro. In that entire length at some point the supply from any of these sub-station will cross each other and the phase may be different. Hence for a section which is nearly equal to the length of the train is provided with no power supply, this section is called as neutral section. In this section the train will not receive any power.

### **2.5.1 Operation of Neutral Detection**

The driver motor car of the train is equipped with neutral detection sensors and the track is provided with magnets at the starting and ending of the neutral section. When the train is in movement the neutral detection sensor will pick up the magnetic signals from the magnet provided at the track and this gives a command signal to open the VCB (Vacuum Circuit Breaker) on the DMC and hence the power supply is cut-off, once the train crosses the neutral section the VCB is closed and again supply is re-stored.



**Figure 4: Neutral Section Detector**



## **2.6 Return Current Path**

The rolling stock gets the power from the Overhead cable that is running above the body. The pantograph collects the current and then feeds to the 3 phase induction motor. This induction motor has gear arrangement and is coupled to wheels; therefore the rotational motion is transferred from the induction motor to wheels. The induction motor also has earthing brushes, current gets collected and then passes through the wheels; since the wheels are in rail and in turn the rails are grounded the complete rolling gets grounded.

## **2.7 Why single phase and Why not three phase?**

Initially when the electric traction was developed, we had only DC traction. We were using 1500 DC traction system. In India Kolkata was the first place to use DC traction which was of 3000V DC. They were using DC traction because it was simple to design. But as the load started to increase, DC traction was becoming more rigid. The wires were very thick. Later in 19th century the SNCF (France Railway Network) designed traction for 25Kv single phase. This use of high voltage levels reduced the current and the size for the current carrying conductor thus making it economical, henceforth 25Kv AC transmission was adopted. The induction motor that we are using for traction is a 3 phase induction motor, but the supply that we are getting from the overhead cable is only a single phase 25Kv, therefore the single phase supply is converted to 3 phase by using a converter and inverter arrangement. Now if we use a 3 phase system we require 3 pantographs to get the 3 phase current and the grounding the rolling stock becomes difficult, and where there are crossover there will be lots of wire crossing each other making it difficult for maintenance. Considering all these reasons we use single phase for traction.

Now that the basics regarding the traction systems and the rolling stock is clear, in the further chapters the discussion shall be on the different tests that are performed in rolling stock.

## Chapter – 3: Materials and Methodology

### 3.1 Testing and Commissioning of Rolling Stock





Testing and commissioning is an important aspect in electrical projects as it is mandatory for the equipments and systems on board the metro train to meet the day to day performance criteria. As discussed above a modern day metro train has the most advanced system on board for its performance. The product of ALSTOM – Metropolis which is used for Chennai Metro Rail Project has the capability to function on its own through Automatic Train Operation (ATO) once the train is powered ON. Hence it is clearly understood what will be complexity of the power supply design, control systems, telecommunication and signaling systems and other miscellaneous embedded systems for event management, event recording and the entire operations. Therefore it is necessary to perform all the tests on the train to ensure the integrity of all the systems.

Another important reason testing is that, the trains are made, assembled and tested in factory, but when it reaches the site it is dismantled and it is assembled back at the site, hence there are chances that some parts might have been damaged and some parts might have been malfunctioning due to damage while loading and unloading the train.

The metro trains which are similar to electrical systems have many relays and circuit breakers. It is essential for a testing and commissioning engineer to understand what each relay and circuit breaker does. Also the train has various push buttons, function selector switches and many other switches. Given are the set of cab control that are available and the list of circuit breakers and relays which is available in the driver cabin.

**Table 3: Driver Cab Control Switches**

Picture	Descriptions
	<ol style="list-style-type: none"><li>1. White Push Button – Whistle and Uncoupling</li><li>2. Red Button with Arrow – Emergency</li><li>3. Red and Green Buttons – Doors Close and Open Functions</li><li>4. Black Button – Horn</li></ol>

	<ol style="list-style-type: none"> <li>1. White Push Button – Whistle and Uncoupling</li> <li>2. Red Button with Arrow – Emergency</li> <li>3. Red and Green Buttons – Doors Close and Open Functions</li> <li>4. Black Button – Horn</li> <li>5. Red and Green Buttons – Closing and Opening of VCB</li> </ol>
	<p>Master Controller for Traction. It has 4 options</p> <ol style="list-style-type: none"> <li>1. Motoring</li> <li>2. Coasting</li> <li>3. Braking</li> <li>4. Emergency Brake</li> </ol> <p>To its right it has function selector</p> <ol style="list-style-type: none"> <li>1. Off</li> <li>2. Standby</li> <li>3. Wash</li> <li>4. Forward</li> <li>5. Reverse</li> </ol>
	<p>The black handle is used for operating the backup brake. Operating the valve will either fill the pressure or vent the pressure. Above it there are function switches for</p> <ol style="list-style-type: none"> <li>1. Headlights</li> <li>2. Wiper</li> <li>3. Cab Light</li> <li>4. Parking Brake</li> <li>5. Cab Ventilation</li> <li>6. Reading Light</li> </ol>
	<p>This picture has the measuring panels of and SCADA screen which displays the driver with information regarding the train.</p> <p>Measurement Panels – Pressure measurement in main and auxiliary reservoir.</p>



Passenger Announcements and Passenger Information Systems (PA-PIS)

Automatic Train Protection (ATP) and Automatic Train Operation controls (ATO)

The various circuit breakers that are present in the Driver Cab area are as given below.

**Table 4: Circuit Breakers**

<b>Circuit Breaker Name</b>	<b>Description</b>
CB.AGTUM	Compressor Motor Circuit Breaker
CB.AGTU	Compressor Command Circuit Breaker
CB.ATP1	Automatic Train Protection 1
CB.ATP2	Automatic Train Protection 2
CB.PB	Parking Brake Circuit Breaker
CB.BL	Brake Loop Circuit Breaker
CB.SBLA	Service Brake Auxiliary Loop Circuit Breaker
CB.BCE	Brake Control Electronic Circuit Breaker
CB.BI	Brake Isolation Circuit Breaker
CB.EB1	Emergency Brake Circuit Breaker 1
CB.EB2	Emergency Brake Circuit Breaker 2
CB.AC1	Air Conditioning and Ventilation Circuit Breaker 1
CB.AC2	Air Conditioning and Ventilation Circuit Breaker 2
CB.CAM	Camera Circuit Breaker
CB.COM	Communication Circuit Breaker
CB.ID	Internal Display Circuit Breaker
CB.FD	Frontal Display Circuit Breaker
CB.DGC	Door Command Circuit Breaker
CB.DCR1	Door Command Right Circuit Breaker 1
CB.DCR2	Door Command Right Circuit Breaker 2
CB.DCL1	Door Command Left Circuit Breaker 1
CB.DCL2	Door Command Left Circuit Breaker 2
DC.DCU1	Door Control Unit Circuit Breaker 1
CB.DCU2	Door Control Unit Circuit Breaker 2

CB.TWU	Train Wakeup Unit Circuit Breaker
CB.COR	Cab Occupied Circuit Breaker
CB.HU	Horn Circuit Breaker
CB.WW	Windshield Wiper Circuit Breaker
CB.SL1	Saloon Lights Circuit Breaker 1
CB.SL2	Saloon Lights Circuit Breaker 2
CB.CL1	Cab Lighting Circuit Breaker 1
CB.CL2	Cab Lighting Circuit Breaker 2
CB.CL3	Cab Lighting Circuit Breaker 3
CB.TRAZA	Traction A Circuit Breaker
CB.TRAZB	Traction B Circuit Breaker
CB.CVCB	Close Vacuum Circuit Breaker
CB.RIOM1	Remote Input Output Module Circuit Breaker 1
CB.RIOM2	Remote Input Output Module Circuit Breaker 2
CB.RIOM3	Remote Input Output Module Circuit Breaker 3
CB.RIO11	Read Input Output Circuit Breaker
CB.RIO21	Read Input Output Circuit Breaker
CB.RIO31	Read Input Output Circuit Breaker
CB.DDU	Driver Display Unit Circuit Breaker
CB.MPU	Main Processing Unit Circuit Breaker
CB.EVR	Event Recorder Circuit Breaker
CB.24V	24V Network Circuit Breaker
CB.DSS	Speed Zero Supply Switch
CB.RT	Radio Transceiver Circuit Breaker
CB.TCCU	Train Communication Control Unit Circuit Breaker
CB.RAD	Radio Circuit Breaker
CB.AUXL	Auxiliary Supply Circuit Breaker

CB.HMI	Human Machine Interface Circuit Breaker
CB.ATO	Automatic Train Operation Circuit Breaker
CB.ATCEXT	Automatic Train Control Circuit Breaker
CB.WP	Wiper Circuit Breaker
CB.CB	Cab Booster Circuit Breaker
CB.S	Power Socket Circuit Breaker

As mentioned in above table, the similar circuit breakers are present in the other driver cabin also. This makes a total of 135 MCB's in the DMC, also there are some MCB's present in Trailer Car also. The above mentioned circuit breakers are operated by the help of relays. The lists of these relays are given below.

**Table 5: Relay List**

<b>Relay Name</b>	<b>Description</b>
R.COR1 TO R.COR6	Cab Occupied Relay
R.EB1	Emergency Brake Relay 1
R.EB2	Emergency Brake Relay 2
R.SZ1	Speed Zero Relay 1
R.SZ2	Speed Zero Relay 2
R.SBL	Service Brake Loop Relay
R.DARS	Door Open Authorization Relay – Right Side
R.DLRS	Door Lock Right Side Relay
R.DALS	Door Open Authorization Relay – Left Side
R.DCLS	Door Close Left Side Relay
R.ATO	Automatic Train Operation Relay
R.ATOD	Door ATO relay
R.CORS	Cab Occupied Relay
R.CDLS	Close Door Limit Switch Relay
R.RM	Rescue Mode Relay
R.NS	Neutral Section Relay

R.BL	Brake Loop Relay
R.PBS	Parking Brake Pressure Switch Relay
R.NCOR	No Cab Occupied Relay
R.DRATOL	ATO Opening Door Relay (Right Side)
R.DRATOR	ATO Opening Door Relay (Left Side)
R.CL	Door Close Left Relay
R.CR	Door Close Right Relay
R.MF.BCE	Major Fault Relay. Brake Control Electronics
R.REV	Reverse Relay
R.TWU	Train Wakeup Relay
R.PA	Passenger Announcement Relay
R.PE	Pulse Enabled Relay
R.DM1	Dead Man Relay 1
R.DM2	Dead Man Relay 2

These above mentioned relays along with the circuit breaker ensure the safe operation of the train and safe transit for the passengers. The detailed explanations of the functioning of the relays are discussed along with the resting procedures.

The given below are the tests that are performed by ALSTOM once the train is arrived on site.

1. **New Train Reception** – In this it is ensured that the train arriving at depot site has no physical damages and it matches the client specification. This is just an overall visual inspection of the coaches. Once it is arrived all the necessary mechanical couplings are done and then cabling is provided for telecommunication, signaling and power supply. After cabling is provided the train is woken up.
2. **Non – Regression Static Test (NRT) / Static Test** – In this test the train is powered up by the auxiliary supply and the functioning of all the equipments under static conditions are checked. This test has around 25 sections which will have to perform.
3. **Routine Dynamic Test (RDT)** – In this test the train is fit to move in the test track and all the systems on board are tested when the train is in movement. This majorly includes acceleration, deceleration, braking etc.
4. **Signaling Test** – In this test the train's signaling systems are check thoroughly. This includes reception of signals and communication from sensors, instrumentations and OCC.
5. **Joint Test** – In this train is moved to the main line and the integrity of all the systems are checked, such as opening of doors in platforms, opening and closing of VCB automatically once neutral section is detected etc.



6. **Burn In Test** – In this test the train is operated in the main line for 1500kms and there must not be any failure. If there are any failure then then failure is rectified and the train is again run for 1500Kms. Once the completion of 1500kms and there is not fault, the train is fit for commercial run.

Known all the relays and circuit breaker that are onboard, now the first step before starting the tests on train is to wake up the train. If wakeup is successful then each sections can be covered step by step.

### **3.2 Train Wakeup Procedure**

1. Perform visual check of the entire train for any damages in cables, pressure devices and other equipments.
2. Ensure all the mechanical coupling, cabling is provided.
3. Bring the battery lever to service position.
4. In the driver cabin, press **BATTERY CONNENCT** for about 10s, after 10s, the cab lights must be on. This ensures the wakeup of train
5. Now we can connect the shore supply (auxiliary supply) and switch on.
6. Insert master key in the driver cabin
7. With function selector put the function to standby and then, turn on the train.
8. Now the train is ready for further testing procedures.
9. Open the **SCADA (DDU)** screen and look for the failures that the train is indicating and accordingly with reference with Train Schematic troubleshooting can be started.

Once the train has been switched on for the first time then, with each sections of the train can be tested sequentially. The procedure for testing each system is as mentioned below.

### **3.3 Non-Regression Testing (NRT)**

The systems that are tested under this section are as follows.

1. Door Control System
2. Return Current Test
3. Traction Control System
4. Passenger Announcement and Passenger Information System (PA-PIS)
5. Brake Control Systems
6. HVAC (Testing only with HV Supply)
7. CVS Command Test (Testing only with HV Supply)
8. Lighting Test
9. Vehicle Networks Test
10. Functionality Checks of the System on-board
11. Miscellaneous Body Checks (Leveling of Train with respect to platform)
12. Pneumatic Tightness Test
13. Compressor Test (Only with High Voltage Supply)
14. Traction Authorization Test

**Train Wakeup** – This is the preliminary process to be done before switching on the other equipments after the train has arrived at the Inspection Bay Line. For train wake up first ensure that the pantograph of 2 cars is in cut-out position and only the following switches are ON.

1. CB. TWU – Train Wakeup Unit
2. CB. RIOM – Remote Input Output Module
3. CB.RIO – Read Input Output
4. CB.MPU – Main Processing Unit
5. CB.DDU – Driver Display Unit
6. CB.TRAZ – Traction
7. CB.EVR – Event Recorder

**Pre – Test Checks:** Once the train is switched on for the first time, initially check the Driver Display Unit (DDU) for the software versions that is installed, check with the latest version if the versions do not match then first provide the latest software update with the help of ALSTOM train troubleshooting tool and then proceed for testing of the systems on board. The given below is the procedure for updating latest software package.

1. Open the software screen in the DDU and look for the software versions and look into which all the systems with old software versions. The following are the possibility of system with old software versions and the screen shots of the versions of the software of equipment is given below in figure 5. If the version is displaying 0.0.0 then check for the corresponding circuit breaker, if off then make it ON and check for the version. If there is no change in the version then software is not installed for the equipment and hence the equipment will not function.

Equipments	Software version
ACU 1 (DC)	1.1.0
ACU 2 (DC)	1.1.0
ATC 1 (DMC)	0.0.0
ATC 2 (DMC)	0.0.0
PCE 1 (DMC)	0.0.0
PCE 2 (DMC)	0.0.0
PCE 3 (DMC)	0.0.0
PCE 4 (DMC)	0.0.0
DDU 1 (DMC)	1.0.0
DDU 2 (DMC)	1.0.0
DDU 3 (DMC)	1.0.0
DDU 4 (DMC)	1.0.0
EVR (DMC)	1.0.0
MPU 1 (DMC)	0.0.0
MPU 2 (DMC)	0.0.0
PCE 1 (DMC)	0.0.0
PCE 2 (DMC)	0.0.0
PCE 3 (DMC)	0.0.0
PCE 4 (DMC)	0.0.0
RCCU 1 (DMC)	0.0.0
RCCU 2 (DMC)	0.0.0
UMC (DMC)	0.0.0

**Figure 5: Software Version Screen from DDU**

- a. Propulsion Control Electronics (PCE)
- b. Driver Display Unit (DDU)
- c. Main Processing Unit (MPU)
- d. Universal Mobile Controller (UMC)
- e. Brake Control Electronics (BCE)

Procedure for updating individual software package is as given below.

**a. Propulsion Control Electronics (PCE)**

1. Shutdown the train and remove the shore supply connection (Connection to Auxiliary Power Supply)
2. Open the traction control unit cover
3. Remove all the CAN and RS232 bus connections.
4. Plug in the MOXA Cable (RS232 to USB converter cable)



**Figure 6: Propulsion Control Electronics System**

5. Open the Flash32 software tool in Train Maintenance Laptop
6. Select the traction software package
7. Set the BAUD rate to maximum limit and the parity to NONE from the settings panel of the Flash32 tool
8. Click on program and wait for the response
9. Once updated power on the train and look for the version in software screen

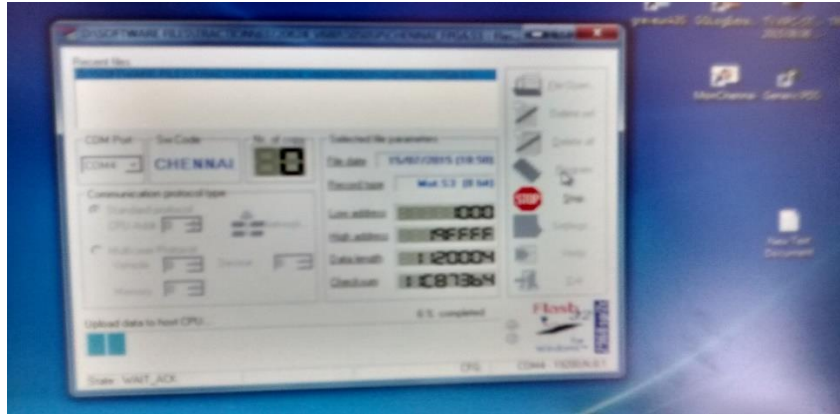

**Figure 7: Propulsion Control Electronics Software Installation**

**b. Driver Display Unit (DDU)**

1. Power on the train and activate the cabin in which the software needed to be updated
2. Isolate the power to DDU
3. Open the DDU cab beneath the DDU and plug in the USB loaded with latest software for DDU
4. Power on the DDU by making the CB.DDU high
5. The software will be automatically installed by the DDU and pops up a message to reboot the DDU
6. Power off DDU and then Power it ON by operating the CB.DDU switch
7. The DDU is loaded with latest software version

**c. Main Processing Unit (MPU)**

1. Power on the train and activate the cabin in which the software needed to be updated
2. Isolate the power to MPU
3. Open the MPU's USB slot and plug in the USB loaded with latest MPU
4. Power on the MPU by making the CB.MPU high
5. The software will be automatically installed by the DDU and pops up a message to reboot the MPU
6. Power off MPU and then Power it ON by operating the CB.MPU switch
7. The MPU is loaded with latest software version



**Figure 8: Main Processing Unit (MPU)**

**d. Universal Mobile Controller (UMC)**

Configuring the software for this particular equipment is carried out in 2 parts, initially the equipment is removed from the panel board and the Flash card of it is cloned with the help of ALSTOM Compact Flash Cloner software. Once this is over replace the equipment in the panel and power on the UMC circuit by switching in CB.COM. This is the first step. Once this process is over then with the help of Ethernet cable and GenericPDS software tool install the UMC media packages which will has the software for PA-PIS.



**Figure 9: Event Recorder and Universal Media Controller**

**e. Brake Control Electronics (BCE)**

Brake Control Electronics are not in the scope of ALSTOM. The brake system, pneumatic and the door control units are provided by Faively Transport. Hence the software is also installed by their representative. The procedure is as follows.

1. Open the EPAC unit of the train
2. Plug in the RS232 cable
3. Open the BCE software updating tool provided the Faively
4. Install the latest version of the software
5. Once installed, then test the software. This will release the pressure from the brake cylinder (Only Partial). This completes the software installation for Brake Control Electronics.

This completes the various procedures for installing software for different equipments onboard the train.

Now the train is ready for testing and commissioning. In the further sections we can see the procedures for testing different equipments of the train.

### **3.4 Non – Regressive Testing (NRT)**

This is the test that is performed once the train has undergone Routine Static Test (RST). In this test the train is parked at Inspection Bay Line (IBL) and only with the help of auxiliary supply to the Static Inverter (SIV) the test is conducted. Before powering up the train with shore supply check the continuity of the power cables in the LV box and check of grounding. The test procedures for different equipments are as follows.

#### **3.4.1 Train Wakeup**

- a) Insert the master controller key in the slot
- b) Bring the function selector to standby position
- c) Switch On the train
- d) Wait for the DDU display, once the display is ON then check for the faulty systems and then accordingly start the trouble shooting.
- e) Now with one cab active, try to activate the other cab. It must not become active. If happens then proceed with trouble shooting.
- f) Switch off the train and the train must shut down in 1 min exact.



**Figure 10: Driver Display Unit**



**Figure 11: Train Shutdown**

#### **3.4.2 Miscellaneous Body Checks (leveling)**

In this test the floor of the train is leveled with respect to the platform height, also the pressure in the secondary suspension is adjusted to the required need. This is very important because if the leveling of the train is not in par with the platform then application of brakes and opening of doors will be proper, as the operation of these are dependent on the leveling of the train. Given below table provides the value for pressure and height requirements.

**Table 6: Pressure and Height Requirements**

<b>CAR</b>	<b>Pressure(Bar)</b>	<b>Tolerance</b>	<b>Height(mm)</b>	<b>Tolerance</b>
Driver Car	3.55	+/- .25 Bar	1120	+10mm, -20mm
Trailer	3.8	+/- .25 Bar	1120	+10mm, -20mm

Once the above mentioned pressure and height is set, then the entire height of the train is calculated as given below

**For Driver Car**

***Total height of the car = average of heights of both suspension + 2794mm***

**For Trailer Car**

***Total height of the car = average of heights of both suspension + 2928mm***

Some of the basic details of the secondary suspension are as given below.

1. The secondary suspension consists of two air springs per bogie located between the bogie frame and the bolster, allowing car body vertical and lateral motions.
2. Emergency rubber springs ensure the suspension function in the event of air spring deflation.
3. Car body motions are damped by 2 outboard vertical and a single lateral hydraulic dampers.
4. Car body lateral travel is limited by two rubber bump stops fitted to the pivot.

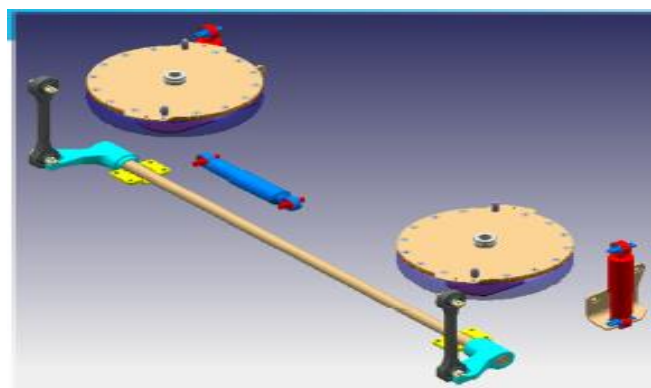

**Figure 12: Secondary Suspension**

The procedure for performing leveling operation is as given below

- (1) Switch ON the train
- (2) Provide the shore supply



- (3) Ensure that there is no heavy materials or people movement inside the train as the presence will affect the measurements
- (4) Check for the pressure and height of the particular car, if it is within the limits then move on to the next bogie for measurements.
- (5) If the pressure and the height doesn't match the requirements then with the help of the pressure adjustment screw adjust the pressure. By doing this the height of the car is adjusted accordingly.
- (6) If the pressure or height is not getting adjusted with the screw adjustment then with the help of test point deflate the secondary suspension and also operating the ASIC (Auxiliary Suspension Isolation Cock), then with compressor running inflate the suspension and then do the adjustment.

Given below pictures shows us how the testing is performed.

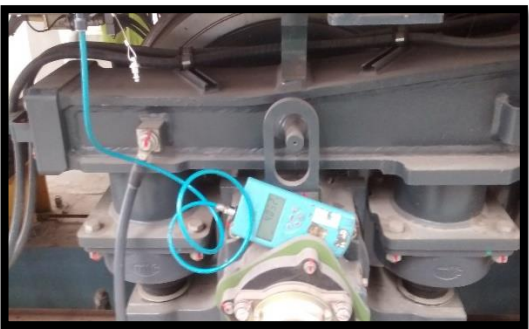
Picture	Description
	<p>Pressure screw adjustment for meeting the required height and pressure in the secondary suspensions</p>
	<p>Pressure measurement of secondary suspension with the help of Digital Manometer.</p>

	<p>Leveling and Height measurement of the train.</p>
---	--

**Table 7: Train Leveling Procedure**

### **3.4.3 Passenger Announcement and Passenger Information Systems (PA-PIS)**



PA-PIS is the announcement and information system that is on board the train which will help the passengers to know about the details of next station, emergency situations etc. For this to be enabled all the cars of the train is equipped with metro route maps of which one is static and the other is dynamic. It is called as **static route map (SRM)** and **dynamic route map (DRM)**, this displays the route of the metro and the current location of the train. The cars are also equipped with speakers, emergency contact intercom, internal LED displays etc. The various tests and their procedures are as given below.

#### **3.4.3.1 CAB – CAB Test**

1. Bring the battery to service position
2. Switch ON the train from any one of the CAB
3. Once ON, ensure that the switch CB.COM and CB.24v is switched ON
4. Press the CAB push button on the driver panel, now the CAB to CAB is active
5. Now the driver from the active CAB can communicate to the person/CAB in non – active CAB

Given below table shows the list of components involved in this testing

**Table 8: PA-PIS System Components**

Picture	Description
	<p>The Push-buttons in the white colors are used for communicating with the passengers.</p> <p>PTT – Push To Talk push button must be pressed in order to give announcements to the passengers with the help of mike</p> <p>PA – By acknowledging passenger announcement, the driver can give announcements to the passengers</p> <p>CAB – For communicating with other CAB</p> <p>PEI (Red Button) – Passenger Emergency Intercom</p>
	<p>Internal Speakers for passenger announcements</p>
	<p>Internal Display for Passenger Information</p>

	<p>Passenger Emergency Intercom for communicating with Train Operator in case of Emergency</p>
	<p>Driver CAB speaker.</p>
	<p>Dynamic Route Map from which the passenger can understand which station is next, and how many stations are left for his/her destination by the help of the LED's</p>

### 3.4.3.2 Passenger Emergency Intercom

Passenger Emergency Intercom is provided in every single car of the train. This particular device must be accessed only if the passenger is in emergency. Once this device is used a pop-up is displayed in the DDU along with that the PEI push button is activated. To communicate with the passenger, the driver in the CAB must first acknowledge the signal by pressing the PEI push-button. Then the train operator can contact the passenger and address the needs.



**Figure 13: Passenger Emergency Intercom**

The procedure for testing this section is as given below.

1. Switch ON the train
2. Ensure the CAB is active
3. Ensure that CB.COM and CB.24v is ON.
4. Activate the PEI from the train
5. Check the DDU for the display of PEI notification and the glow in the PEI push button.
6. Acknowledge the request by pressing the PEI push-button, once acknowledged the driver can talk with the passenger and see to that the need is addressed.
7. With the help of Push to Talk push button, talk with the passenger to attend his/her problem. The voice of the train operator must be clear and loud enough, also the passenger's voice must be loud and clear.

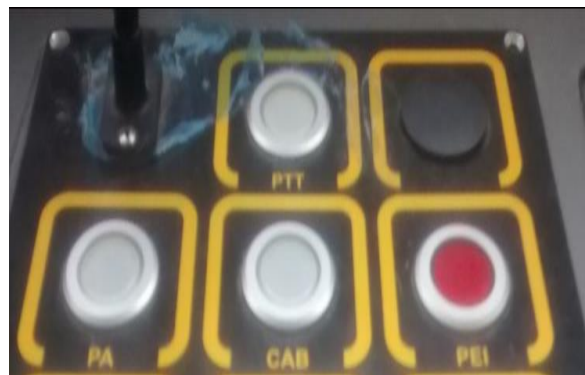

**Figure 14: PEI and PA-PIS Control Push-Buttons**

### 3.4.3.3 Passenger Announcement and Information Systems

In this the train is programmed with pre-defined messages that will be played in the speakers and displayed in the internal display of the train. The procedure for testing this section is as given below.

- a. Switch ON the train
- b. Ensure that CB.COM and CB.24v switches are ON
- c. From the DDU open PA-PIS test page as shown in figure 12
- d. Play the pre-defined messages and ensure that the selected message is played on the speakers and it is displayed in internal speakers. The announcements must be loud and clear
- e. Ensure that the played messages is audible in all the cars and in all the provided internal speakers
- f. Push the PA push-button and with help of provided mike make announcements and ensure that it is audible throughout the train.

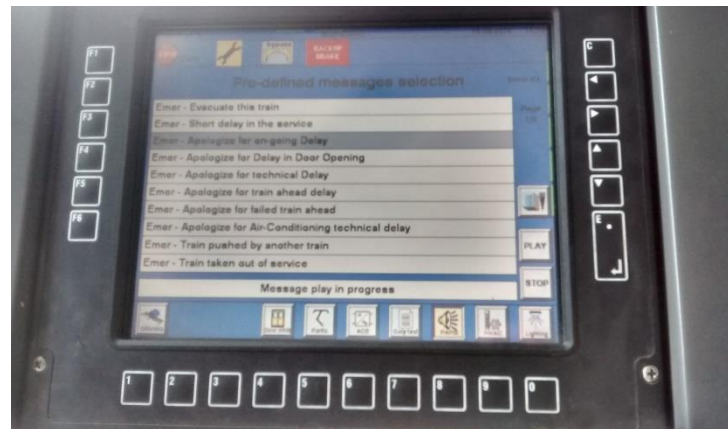
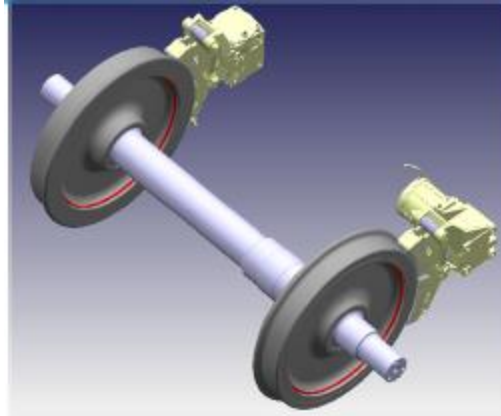

Figure 15: Pre-Defined Messages in PA-PIS

### 3.4.4 Brake Test

Metro trains are equipped with 4 different braking systems, but physically if we observe the bogie we can find 2 brakes. One is behind the wheels and the other is mounted in the axle. This is the disc brake of the train. The different braking systems of the train are as follows.

1. Service Brakes / Regenerative Braking
2. Parking Brake
3. Emergency Brake
4. Backup Brake



**Figure 16: Mechanical Tread Braking Unit**

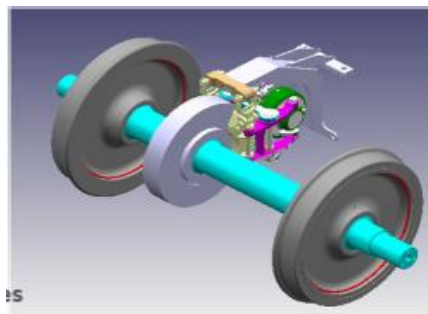

**Figure 17: Disc Brake**

The fig. 15 and 16 shows the mechanical brake assembly. Under any conditions, these are the brakes that will be operated when the train is in braking mode. The first brake that will come into picture is the regenerative brakes, in which the motors of the train behaves like generator and brings the train to standstill. Until the train reaches the speed of 10kmph the regenerative brakes will be functioning, beyond that it's always the mechanical braking that is present in the train. The mechanical brakes are operated with pneumatic systems for which there are compressors and air reservoirs fitted beneath the systems.

The reason behind providing 5 braking system is for the redundancy. If one of the systems fails, with the help of the other system we can bring the vehicle to standstill condition. If all the brake systems fail, the last option is to use the backup brake.

To ensure all the braking system is working fine, braking test is done.

#### **3.4.4.1 Parking Brake**

1. Switch ON the train and make the cabin active.
2. Ensure all the brake isolation corks are in its normal position
3. Connect the shore supply and let the compressor run if there is no sufficient pressure in the reservoir

4. Once the pressure reaches 9 Bar, with the help of selector switch in cab panel, put in apply position.
5. Now the parking brakes are ON, the LED glows indicating the brakes are ON and in the DDU, there is an indication of parking brakes applied condition



**Figure 18: Parking Braking Selector Switch**

#### **3.4.4.2 Backup Brake**

1. Switch ON the train and make any one of the cabin active
2. Connect the shore supply and allow the compressor to run in order to fill the reservoir with air
3. Once the pressure reaches 9 bar with the help of selector switch in CB panel board, make the backup brake “ON”
4. Now in DDU there must be indication of Backup Brake
5. Put the selector switch in forward position
6. Now release the master controller from emergency braking position and just bring it to braking position
7. The pressure from the reservoir is released
8. With the help of Backup Brake valve now fill the brake pressure cylinder and ensure that the brake cylinder pressure is 5 Bar
9. Now bring the valve to VENT position. This makes the brakes to apply and the same can be seen in the DDU.



**Figure 19: Backup Braking Operating Rod**



### 3.4.4.3 Emergency Brake

Emergency brakes are applied only when there is an emergency situation in the train such as passenger operates EED, service brake failure any movement across the train when the train is in main line. But the different conditions the emergency brakes will be applied automatically are as follows.

1. **Dead Man** – This is a condition in which the train operator (TO) has removed his hand from the master controller. Under this condition the preloaded algorithm considers that the TO has either slept or become unconscious and hence the emergency brake is activated. When the train is in coasting mode and if the TO removes his hand, then the dead man must be activated and the emergency brake must be applied within 6 seconds. This adjustment of the Dead Man activation can be adjusted with the help of time setting in the Dead Man relay panel.



Figure 20: Dead Man and Emergency Brake Indicators



Figure 21: Dead Man Time Setting Relay

### 2. Push Button Activation

Emergency Brakes can be activated with the help of push buttons that is provided in the Driver Cabin. Switch ON the train and ensure there is sufficient pressure in the reservoir, put the master controller in forward position and now push the emergency brake button. In the DDU there must be a display of EB activated with push button.



**Figure 22: Emergency Push Button**

### **3. Low Pressure in Brake Cylinder**

Whenever the pressure in the brake cylinder falls below 7 bars, the emergency brake is activated and along with that the compressor is turned ON in order to bring back the pressure to 9 Bar. In order to reduce the pressure we can do by moving the master controller from motoring to braking again and again. This will cause the pressure to drop in the brake cylinder and hence application of emergency brakes.

### **4. Emergency Brakes Through Master Controller**

This option is available with the master controller itself. When the braking is not achieved, if we bring the master controller handle a level down, then the emergency brake will be applied.



**Figure 23: Emergency Brake in Master Controller**

#### **3.4.5 Pneumatic Tightness Test**

The entire braking system of the train is operated through pneumatic systems. This includes the horn also. Hence the train is equipped with a main compressor which runs automatically when the pressure in the main reservoir is below a certain value. The air getting filled in it is responsible for the secondary air suspension, brakes, functioning of the horn etc.

Air Similarly to electricity cannot be stored; as it is continuously moving and hence achieving a perfect air tight pressure vessel is not possible. There will be air flow out of

the train when the train is in operation. This might be due to operation of brakes, change of train state from braking to motoring, use of Horn etc. Hence to ensure the proper functionality of the systems mentioned there must be sufficient pneumatic tightness with an acceptable tolerance. The procedure for carrying out the test is as given below.

1. Switch ON the train
2. Plug in the Shore Supply
3. Ensure that RM switch is in ON position. This allows the compressor to run
4. Let it fill the reservoirs and once it reaches 9 bar pressure, switch off the compressor unit by making CB.AGTU low.
5. Now wait for 3 minutes for the air pressure to stabilize.
6. With the help of manometer measure the pressure in Main Reservoir, Auxiliary Reservoir, and Brake Cylinder
7. With the manometer installed at test points, now wait for 10 minutes. The pressure difference shall not be more than .25Bar

**Table 9: Braking Systems**

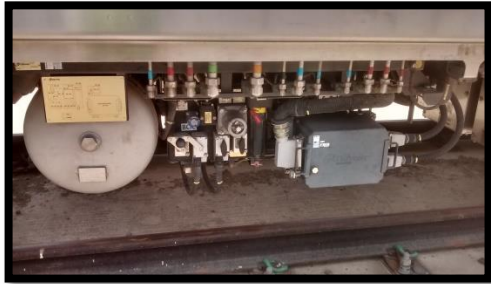
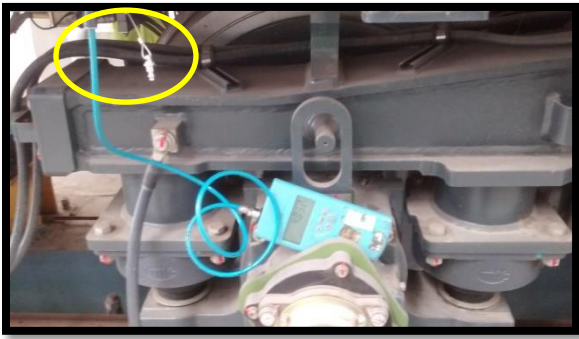
Image	Description
	<p>Main Reservoir</p> <p>BPIC – Brake Pressure Isolation Cork</p> <p>ASIC – Auxiliary Suspension Isolation Cork</p> <p>PBIC – Parking Braking Isolation Cork</p>
	<p>Pressure Measurement of the Secondary Suspension with help of manometer</p> <p>Circled Location – Pressure Test Point</p>

### 3.4.6 Lighting Test

Lighting is considered to be one of the important factors in case of passenger comfort and safety. All the metro trains are equipped with good lighting systems. In case of Metropolis series it has light sensors in the 2 driver cabs. This sensor converts the

irradiance to electrical signals and according to the irradiance received the lights inside the train is controlled. Apart from this the lighting can be controlled by its individual CB.SL switches in respective cars. This will result in partial loss of lighting in each car, but not complete loss of lighting. Procedure for testing is as given below

- i) Switch ON the train and make any of the CAB active
- ii) Ensure that CB.SL switches are ON in both the CAB sides; also ensure that the same switches are ON in the Trailer Car also.
- iii) Now close the light sensor in front with an opaque object such that there is no light falling in the sensor. Now all the lights must be ON in the train.
- iv) Now operate the corresponding the car's CB.SL switches and check for the partial loss of lighting in each car.

### **3.4.7 Doors Test**

Doors makes a larger number in case of every automotive starting a 4 wheeler to a large scale trains. It provides safety and comfort for the passengers inside the vehicle. In case of Metropolis every car has about 8 doors, 4 doors on the left and 4 doors to the right. Every door is looped and it has the following relays in it which is responsible for its operation. The relays are R.DARS, R.DALS, R.ATOD, R.CDLS, R.DRATOL, and R.DRATOR. Relays DARS is responsible for doors open and close authorization. This relay gets picked when the door open or close command is given by the driver from the cabin. Similarly when the train is operating under Automatic Train Operation (ATO) mode, the relays ATOD, DRATOL and DRATOR is responsible for the opening and closing of doors. Also for the indication to appear in the DDU, there is a limit switch CDLS (Close Door Limit Switch) which gets picked and send the communication to the MPU and then gets displayed in the DDU.

The following are the specification of the Door System on board.

- ▶ Door Opening Stroke : 1400 mm +10mm
- ▶ Opening & Closing Time: 2.5s  $\pm$  0.5s
- ▶ Operated by Permanent Magnet DC Motor
- ▶ Current Max:1.35Amps. Voltage 110V  $\pm$  30%
- ▶ Whole Operation Controlled By EDCU
- ▶ Smallest Obstacle detection Facility 10mm
- ▶ Force Applied on each Door leaf during opening: 150N
- ▶ Force Applied on Each Door Leaf during Closing: 150N
- ▶ Working Temperature : -25 °C to +40 °C
- ▶ Temperature storage range : -35 °C to +70 °C

**Figure 24: Door Specifications**

For opening and closing certain conditions must be met, and it is divided in 2 levels namely the train level and door level

#### Conditions at Train Level

1. The door will not open when there is “No OPEN Command”
2. The doors will not open if there is not zero speed signal and even if Open command is given
3. The will not move with an Open Door

#### Conditions at Door Level

1. The doors will not lock / close if an obstacle is found
2. The doors will close if the zero speed signal is lost

It is very common in every day commute that a person might try to enter a train while the doors are closing, in order to avoid any mishaps the trains are equipped with obstacle detection system which will open the doors if it detects any obstacle. In Metropolis, the obstacle detection is up to 10mm, that is even is an obstacle of 1cm is stuck, the doors will open. The logic of this is given below.

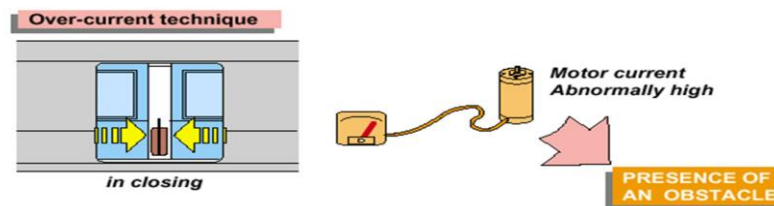

**Figure 25: Obstacle Detection**

In Metropolis the obstacle detection is done with the help of over current technique. Every door has a PMDC motor and during its normal operation it takes a normal current. When an obstacle is detected the motor tries to close it by drawing more current. This current is sensed by the current sensor and sends command to the Electronic Door Control Unit (EDCU), now this will partially open the door so that the obstacle is removed, if not happens it partially opens and closes 2 times, if not able to close after 2 tries, the door opens fully and then only by a close command the doors are closed.

Apart from this feature every car has EED (Emergency Egress Device) fixed which can be operated by the passenger in case of emergencies. The following is the figure and the sequence of operation of the EED.



**Figure 26: Emergency Egress Device**

1. The train is in motion and hence there is no zero speed signal
2. Passenger in the train due to emergency operates the EED.
3. There is an indication in the DDU telling the driver that there is an emergency. The door just gets unlocked but it cannot be opened unless the traction management system gets a zero speed signal
4. Once speed zero signals are achieved by emergency brake application, the train comes to stand still, speed zero relay is energized, command from the TCMS is sent to the EDCD for opening the doors.
5. The doors can be opened manually and the passenger can walk out of the train

### **3.4.8 Return Current Test**

Every electrical circuit must have a return path, similarly a train also has its return path. As discussed in the introduction to traction power supply it's evident that the train collects the current from the overhead conductor or a parallel 3<sup>rd</sup> rail in case of DC traction system. This current enters the various sections of the trains and components and each component is grounded to the train body, and finally the entire ground is given to the earthing bush which is fixed along the outer periphery of the axle. This axle is in turn in touch with the rails which are at a frequent interval grounded. In this way the train gets its return and grounding. The following is the procedure for performing the test.



**Figure 27: Earthing Bush**

1. Ensure there is no one inside the train
2. Barricade the train section for safety

3. Ensure the points in the rail at which test is going to be conducted is free from dust and rust
4. Loosen the grounding cables from the earthing bush
5. With help of inverter source provide supply to the train at any point, the train body is charged and make sure no one is near it.
6. Increase the current supply to 50A.
7. Now with the help of measuring instrument measure the resistance of the car body.
8. The resistance value shall not be more than .5 Ohms

**Note:** This test is a High Risk test and hence proper electrical safety must be provided to the train and to the personnel who is conducting it. The safety for the train can be achieved by operating the Earthing Ground Switch inside the train and for the personnel; the safety can be achieved by using electrical safety gloves and earth mat.

### 3.4.9 Vehicle Networks Test

This is one of the most important tests that are performed to ensure that proper functioning of the networks of the train. In metropolis, the door control units, VAC units and the brake networks are controlled by CAN (Controller Area Network) bus network and Echelon networks. CAN bus network is used for all the door control units and the VAC units whereas the brake control system is taken care by Echelon networks. These are nothing but communication and control BUS that runs throughout the train and it has certain variables which will hold the logical value of the control network. Apart from the mentioned 2 networks, one more network that controls the entire communication systems of the train is MVB (Multiple Vehicle Bus) network. This network communicates with the TCMS, MPU and other train networks. This network is also responsible for the feedback and the control signals for particular equipment that is connected to the network. Given below figure is the network screen that is visible in the DDU.

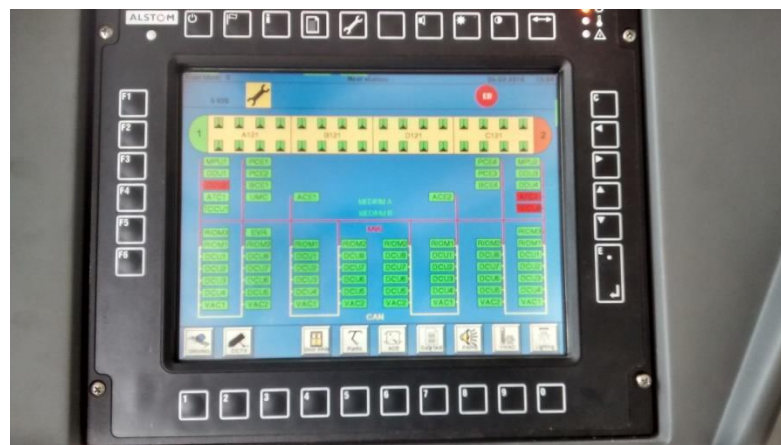

**Figure 28: Networks Screen**

From the networks screen we can see that there are 2 different networks, CAN and MVB. The doors and VAC units are controlled by CAN whereas TCCU, ATC, UMC, MPU are all controlled by MPU. In image the white lines are CAN controlled and the red line is MVB controlled.



### **3.5 Routine Dynamic Test (RDT)**

So far in the above discussion the tests were all static which ensures the functionality of all the systems and equipments on board and the mentioned test is done in static condition. In Dynamic test, the dynamics of the vehicle is tested. In this the vehicle is operated at different speeds and its acceleration and deceleration is noted down for different braking systems. Also the stopping distance is calculated in this and it is verified with theoretical values.

The different tests that are done under this section are as given below

1. Brake Preliminary Verification
2. Pneumatic Service Brake Test
3. Emergency Brake Test
4. Backup Brake Test
5. Service Brake Test
6. Speed Increase
7. Low Voltage Inputs
8. Train to Train tow Test





The procedures for the above mentioned tests are as given below.

#### **3.5.1 Brake Preliminary Verification**

This test is just to verify the functioning of all the brakes. The procedure is as given below

1. Activate the Cabin
2. Ensure that all reservoir pressure is  $\geq 9.5$  Bar
3. Move the master controller to full service brake position and see in the DDU that all the brakes are applied
4. Now release the master controller and check for the release indication in DDU
5. From the selector switch, apply the parking brakes. Now all the parking brakes are applied in all cars. Similarly release the parking braking brakes and check for the indication in DDU
6. With the push button activate the emergency brakes and release. The DDU displays the application of Emergency Brakes through push button
7. Move the master controller to coasting and slowly bring the train to 10kmph speed. Now activate the dead man by continuously keeping the master controller pressed. The emergency brake gets applied in 6 seconds
8. Now release the brakes and again give movement to the train and now bring the master controller to coasting position. Now dead man will be activated and the emergency brakes will be applied in about 30 seconds

**Table 10: Braking Systems Verification**

Picture	Description
	<p>Manometers for air pressure measurements. Ensure that the pressure is more than 9.5Bar</p>
	<p>Dead man indication. When the master controller is continuously pressed or not pressed this gives a buzzer, and if not acknowledged then automatically TCMS sends signal to BCE and emergency brakes are applied.</p>
	<p>Emergency Push Button Emergency brakes can be activated by operating this push button.</p>
	<p>Back Up brake selector switch Pneumatic Backup Brakes can be operated by operating this selector switch</p>
	<p>Master controller in Full Service brake position (FSB)</p>

	<p>Parking Brake selector switch</p> <p>Parking brakes can be applied with the help of this selector switch</p>
---	---

### 3.5.2 Pneumatic Service Brake Test

Pneumatic Service Brake Test is done for different speeds. 40, 60 and 80Kmph. The train is made to run the above mentioned speeds and the braking is tested. Once tested the stopping distance is noted from the vehicle mileage screen and it is verified with the theoretical calculations. This test is valid only on certain conditions which are as given below.

1. The track must be in constant gradient (ideally leveled)
2. Initial speed measured at the application of braking shall not differ more than +/- 3kmph
3. Automatic Train Control must be bypassed
4. Regenerative braking must be disabled
5. Restricted mode must be off

The procedure for carrying out this test is as given below.

- 1) Activate the Cabin and bring the master controller to Coasting position
- 2) Move the master controller to full motoring position
- 3) Once the speed is around 40kmph +/- 3kmph bring the master controller to full service brake position.
- 4) Note the distance at which the train is stopping. Now calculate the corrected stopping distance (in case of non-leveled tracks) and deceleration from the given below formula.

$$S_r = \frac{V_r^2 (S_0 - V_0 * T_e)}{V_0^2 - 2 * \frac{M_s}{M_D} * g * i * (S_0 - V_0 * T_e)} + V_r * T_e$$

Term	Description
$S_r$	Corrected distance in meters
$V_r^2$	Target Speed in m/s
$S_0$	Measured distance in m

$V_0$	Speed measurement at application of braking
$T_e$	Equivalent response time measured from brake cylinder pressure of TC car
$M_s$	Static mass in T
$M_D$	Dynamic Mass in T
$g$	Gravity
I	Gradient in m/m

**Table 11: Corrected Distance Measurement**

The deceleration formula is given by

$$A_e = \frac{V_0^2}{2(S_3 - V_0 * T_e)}$$

Term	Description
$A_e$	Equivalent Deceleration in $m/s^2$
$V_0$	Initial speed in m/s
$S_3$	Stopping distance in m
$T_e$	Equivalent response time

**Table 12: Deceleration Calculations**

A sample calculated values for a certain speed is as in the given below figure.

CHENNAI - Dynamic Type Test (TCMS)										
Test	Register	Target Speed	Real Speed	Stopping Distance	Corrected Stopping	Average Deceleration	Te	I	Theoretical Value	Date
RDT.BRK.PSB.01	RDTBRK.PSB.01.40.Kph.DMC1.01	40	40.10	64.83	64.55	xx	1.64	0.0	67	21-02-2016
	RDTBRK.PSB.01.40.Kph.DMC1.02	40	39.80	64.28	64.84	xx	1.56	0.0	67	21-02-2016
	RDTBRK.PSB.01.40.Kph.DMC1.03	40	40.20	65.89	65.32	xx	1.60	0.0	67	21-02-2016
	RDTBRK.PSB.01.40.Kph.DMC2.01	40	41.40	68.36	64.39	xx	1.52	0.0	67	21-02-2016
	RDTBRK.PSB.01.40.Kph.DMC2.02	40	40.20	64.60	64.04	xx	1.48	0.0	67	21-02-2016
	RDTBRK.PSB.01.40.Kph.DMC2.03	40	40.60	66.26	64.62	xx	1.84	0.0	67	21-02-2016
RDT.BRK.PSB.01	RDTBRK.PSB.01.60.Kph.DMC1.01	60	60.00	131.96	131.96	xx	1.56	0.0	138	21-02-2016
	RDTBRK.PSB.01.60.Kph.DMC1.02	60	60.60	133.42	131.06	xx	1.60	0.0	138	21-02-2016
	RDTBRK.PSB.01.60.Kph.DMC1.03	60	60.50	132.56	130.61	xx	1.72	0.0	138	21-02-2016
	RDTBRK.PSB.01.60.Kph.DMC2.01	60	60.20	128.74	127.99	xx	1.96	0.0	138	21-02-2016
	RDTBRK.PSB.01.60.Kph.DMC2.02	60	61.70	138.60	131.75	xx	1.48	0.0	138	21-02-2016
	RDTBRK.PSB.01.60.Kph.DMC2.03	60	60.50	135.61	133.60	xx	1.64	0.0	138	21-02-2016
RDT.BRK.PSB.01	RDTBRK.PSB.01.80.Kph.DMC1.01	80	80.90	239.80	234.89	1.05	1.60	0.0	235	20-02-2016
	RDTBRK.PSB.01.80.Kph.DMC1.02	80	80.90	238.25	233.47	1.06	1.98	0.0	235	20-02-2016
	RDTBRK.PSB.01.80.Kph.DMC1.03	80	80.70	232.90	229.24	1.08	1.88	0.0	235	20-02-2016
	RDTBRK.PSB.01.80.Kph.DMC2.01	80	80.50	237.84	235.15	1.05	1.88	0.0	235	20-02-2016
	RDTBRK.PSB.01.80.Kph.DMC2.02	80	80.50	231.20	228.56	1.08	1.60	0.0	235	20-02-2016
	RDTBRK.PSB.01.80.Kph.DMC2.03	80	80.30	235.92	234.31	1.05	1.76	0.0	235	20-02-2016

Figure 29: Pneumatic Tightness Test Readings

Fig 28 shows the calculated readings of the stopping distance and the deceleration values. In practical the stopping distance can be seen from the HMI provided and the vehicle mileage screen from the DDU.

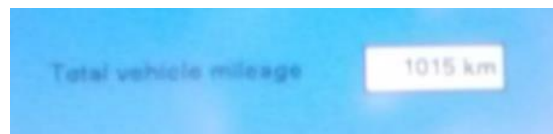

Figure 30: Vehicle Mileage from DDU

### 3.5.3 Emergency Brake Test

The train is equipped with emergency braking mechanism which can be operated when there is a sudden requirement to stop the train. Activating these emergency brakes will bring the vehicle to stand still immediately. The procedure for testing this remains the same as that of pneumatic service brake test i.e. this test is done for 3 different speeds 40, 60 and 80Kmph and the corresponding stopping distance and deceleration values are calculated and tabulated. The only difference in this test is that, instead of bringing the master controller to full service brake position it is kept in coasting position and the push buttons on the driver panel is activated for braking. The calculated values for this test is as given below.

CHENNAI - Dynamic Type Test (TCMS)										
Test	Register	Target Speed	Real Speed	Stopping Distance	Corrected Stopping	Average Deceleration	Te	l	Theoretical Value	Date
RDT.BRK.EB.01	RDT.BRK.EB.01 - 40 Kph - DMC1 01	40	40.80	45.80	44.25	xxx	1.04	0.0	53	21-02-2016
	RDT.BRK.EB.01 - 40 Kph - DMC1 02	40	40.40	45.55	44.85	xxx	0.88	0.0	53	21-02-2016
	RDT.BRK.EB.01 - 40 Kph - DMC1 03	40	40.70	43.30	41.97	xxx	0.76	0.0	53	21-02-2016
	RDT.BRK.EB.01 - 40 Kph - DMC2 01	40	40.10	43.35	43.16	xxx	1.00	0.0	53	21-02-2016
	RDT.BRK.EB.01 - 40 Kph - DMC2 02	40	40.40	43.70	42.95	xxx	0.97	0.0	53	21-02-2016
	RDT.BRK.EB.01 - 40 Kph - DMC2 03	40	41.30	46.28	43.71	xxx	0.84	0.0	53	21-02-2016
Test	Register	Target Speed	Real Speed	Stopping Distance	Corrected Stopping	Average Deceleration	Te	l	Theoretical Value	Date
RDT.BRK.EB.01	RDT.BRK.EB.01 - 60 Kph - DMC1 01	60	61.00	100.32	97.32	xxx	0.96	0.0	111	21-02-2016
	RDT.BRK.EB.01 - 60 Kph - DMC1 02	60	60.10	93.55	93.26	xxx	0.84	0.0	111	21-02-2016
	RDT.BRK.EB.01 - 60 Kph - DMC1 03	60	60.00	91.37	91.37	xxx	0.92	0.0	111	21-02-2016
	RDT.BRK.EB.01 - 60 Kph - DMC2 01	60	60.10	94.48	94.19	xxx	1.00	0.0	111	21-02-2016
	RDT.BRK.EB.01 - 60 Kph - DMC2 02	60	61.00	96.37	93.54	xxx	1.12	0.0	111	21-02-2016
	RDT.BRK.EB.01 - 60 Kph - DMC2 03	60	60.10	92.28	92.00	xxx	1.04	0.0	111	21-02-2016
Test	Register	Target Speed	Real Speed	Stopping Distance	Corrected Stopping	Average Deceleration	Te	l	Theoretical Value	Date
RDT.BRK.EB.01	RDT.BRK.EB.01 - 80 Kph - DMC1 01	80	80.60	167.24	164.92	1.50	1.00	0.0	190	20-02-2016
	RDT.BRK.EB.01 - 80 Kph - DMC1 02	80	80.60	165.70	163.41	1.51	1.00	0.0	190	20-02-2016
	RDT.BRK.EB.01 - 80 Kph - DMC1 03	80	80.70	166.72	164.06	1.51	1.16	0.0	190	20-02-2016
	RDT.BRK.EB.01 - 80 Kph - DMC2 01	80	80.50	175.71	173.67	1.42	0.96	0.0	190	20-02-2016
	RDT.BRK.EB.01 - 80 Kph - DMC2 02	80	80.50	168.06	166.11	1.49	0.92	0.0	190	20-02-2016
	RDT.BRK.EB.01 - 80 Kph - DMC2 03	80	80.60	172.24	169.85	1.46	1.00	0.0	190	20-02-2016

Figure 31: Emergency Brake Test

### 3.5.4 Back up Brake Test

Back up brakes are provided in the trains which will serve if all the brakes have failed to bring the train to stand still position. This can be operated by switching on the backup brakes from the selector switch from the panel. The procedure remains the same for this testing also, except the brakes are applied with the help of the backup brake handle provided at the driver panel. The observed and calculated values of stopping distance and deceleration values for different operating speeds are shown in fig 31

CHENNAI - Dynamic Type Test (TCMS)										
Test	Register	Target Speed	Real Speed	Stopping Distance	Corrected Stopping	Average Deceleration	Te	I	Theoretical Value	Date
RDT.BRK.BB.01	RDT.BRK.BB.01 - 40 Kph - DMC1 01	40	40.30	54.16	53.51	xx	1.90	0.0	81	26-02-2016
	RDT.BRK.BB.01 - 40 Kph - DMC1 02	40	40.00	50.29	50.29	xx	1.56	0.0	81	26-02-2016
	RDT.BRK.BB.01 - 40 Kph - DMC1 03	40	40.50	55.31	54.23	xx	2.02	0.0	81	26-02-2016
	RDT.BRK.BB.01 - 40 Kph - DMC2 01	40	41.30	53.58	50.82	xx	1.60	0.0	81	26-02-2016
	RDT.BRK.BB.01 - 40 Kph - DMC2 02	40	41.40	56.95	53.85	xx	1.84	0.0	81	26-02-2016
	RDT.BRK.BB.01 - 40 Kph - DMC2 03	40	40.70	56.27	54.70	xx	1.80	0.0	81	26-02-2016
RDT.BRK.BB.01	RDT.BRK.BB.01 - 60 Kph - DMC1 01	60	60.20	102.36	101.77	xx	1.64	0.0	153	21-02-2016
	RDT.BRK.BB.01 - 60 Kph - DMC1 02	60	60.40	108.71	107.44	xx	1.52	0.0	153	21-02-2016
	RDT.BRK.BB.01 - 60 Kph - DMC1 03	60	60.10	108.10	107.79	xx	1.64	0.0	153	21-02-2016
	RDT.BRK.BB.01 - 60 Kph - DMC2 01	60	61.80	111.31	105.70	xx	1.60	0.0	153	26-02-2016
	RDT.BRK.BB.01 - 60 Kph - DMC2 02	60	60.90	109.41	106.60	xx	1.64	0.0	153	26-02-2016
	RDT.BRK.BB.01 - 60 Kph - DMC2 03	60	60.30	109.11	108.17	xx	1.76	0.0	153	26-02-2016
RDT.BRK.BB.01	RDT.BRK.BB.01 - 80 Kph - DMC1 01	80	80.50	183.70	181.63	1.36	1.52	0.0	246	20-02-2016
	RDT.BRK.BB.01 - 80 Kph - DMC1 02	80	80.60	184.60	182.12	1.36	1.56	0.0	246	20-02-2016
	RDT.BRK.BB.01 - 80 Kph - DMC1 03	80	80.30	187.89	186.63	1.32	1.72	0.0	246	20-02-2016
	RDT.BRK.BB.01 - 80 Kph - DMC2 01	80	80.10	186.01	185.59	1.33	1.56	0.0	246	26-02-2016
	RDT.BRK.BB.01 - 80 Kph - DMC2 02	80	80.10	192.10	191.67	1.29	1.64	0.0	246	26-02-2016
	RDT.BRK.BB.01 - 80 Kph - DMC2 03	80	80.50	191.47	189.35	1.31	1.84	0.0	246	26-02-2016

Figure 32: Back Brake Test Results

### 3.5.5 Train to Train tow Test

This test is performed in order to check, when two trains are coupled, the train is able to push or pull the other train. This facility is provided because, there are chances that the train that is in commercial run might experience some fault and it might be able to operate, at those critical times the train which is behind the faulty train will either push or pull the faulty train to sliding line. In order to check this coupling tightness and brakes functionality, this test is performed.

### **3.6 Interface Test / Joint Test**

Joint / Interface test is the most important test of all, because after this the train is put in train run for about 1600Kms with a daily restriction of 100Kms per day. In this test the entire train operation with all the train signaling and telecommunication systems interfaces are checked and validated. The test includes train operation, signaling systems of the train, and telecommunications systems on board train. Before understanding the testing procedure understanding of train operation from depot to main line is necessary. The procedure for getting the train from depot to main line is as given below

- 1) Power ON the train in OHE zone and before movement ensure that all systems are functioning properly and there are no IOS (Inconsistent Operating State)
- 2) Ensure that the ATO mode selector switch is in ON position and not it bypass



**Figure 33: ATO Selector Switch**

- 3) Bring the master controller to braking position
- 4) Communicate to the Depot Control Center for movement request
- 5) Once a secret number is exchanged from the DCC to train operator, now the train can be moved to the main line. During this time the track is set by the OCC for the particular train. Once the train reaches the main line every train is provided with a unique train identity which will vary every time.

This is the general procedure for train movement from the depot to main line. Once reaching the main line again communication is made to the OCC for track and route setting. Once route is set and getting clearance from the OCC the train can start its journey.

Train has different modes of operation. Under each operation different automation systems will operate the train and each mode has its own restrictions. The different train operation modes are

- a) **Automatic Train Operation** - In this mode the train is under automatic mode, i.e. the driver will not need to operate the train. The train can run on its own with the help of signaling systems on board. In this mode the train communicates to the signaling circuitry systems on board.
- b) **Restricted Mode** – In this mode the train has a limitation on its speed at certain points such as a deep curve, near station. In this mode if we overshoot the given set speed then emergency brakes are applied and the train comes to stand still
- c) **Rescue Mode** – In rescue mode, the MPU of the train has failed (Both). Under this condition the train will must be got to the depot. Under this mode the train control and



management system (TCMS) has failed. In this mode only 30% of traction is provided, and there is a strict restriction on the speed and the only brakes that are operational under this mode is the backup brake. On entering the rescue mode the DDU of the train shows the given below image.

For interface testing, the train is usually put in ATO mode or in ATP (Restricted) mode.



As mentioned, this test includes testing of communications systems on board also; the test that is done in it is the live passenger announcement system from the OCC, telecommunication facility interface with the OCC, DCC.



In live passenger announcements the announcements of the next upcoming stations, emergency announcements are done directly from the Operation Control Center. By doing this the OCC can send in emergency announcements to the passengers inside the train.

The other test is the calling facility to the DCC and the OCC from the train. The train is equipped with telecommunication facilities. By this the train operator can contact the OCC and DCC and vice versa for movement request and also in emergency condition.

Signaling test will ensure the functioning of the train operation under automatic mode and protection mode. It will also validate the functioning of the dynamic route maps that are installed inside the trains, proper orderly announcements according the stations in the route, docking of train in the station, opening and closing of doors, emergency brake verification during and under and overshoot of the set speed. These are the systems that are covered in the signaling test.

**Table 13: Interface Testing Systems**

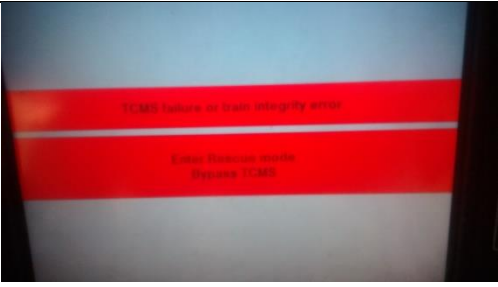
Image	Description
	Train in ATP mode (Restricted Mode) – Train is operated manually with speed restrictions.
	ATP – Automatic Train Protection signaling panel board inside the train with counter to count the number of times the train is operated with ATO cutout

	<p>Dynamic Route Map with LED that glows indicating the stations that has been covered and the number of stations that are left still</p>
	<p>Train Control and Management System failure. Train in Rescue mode wherein we do not have any information about the train and the train is operated manually.</p>
	<p>Train Communication and Control Unit – From this panel we can change the channel for communicating with the DCC and OCC.</p>
	<p>Telecommunication Facility inside the train for contacting the DCC and OCC for requesting train movement and emergency announcements</p>



## **Chapter – 4: Results and Discussions**

Metro trains have the capability to move on its own when it is in Automatic Train Operation (ATO) mode. This is only possible because of the sensors deployed on the tracks, stations and the control circuitry onboard the train. The sequence of train operation in ATO mode is discussed below.

- 1) The train is got to the main line by the train operator in manual operation by coordinating with the OCC and DCC.
- 2) Once the train is on the line main the route for the particular train and its identity is set by the OCC, and now the train is set for its mission.
- 3) Once the mission route is set, the ATP (Automatic Train Protection) system onboard the train is ready for its control action.
- 4) Driver acknowledges the Automatic Train Operation system with a push button and now the control circuitry is connected with the field sensors and starts receiving data through wireless communication mode.
- 5) Now the sensors (Axle Counters) deployed throughout the track length is active. Once a train starts to cross it, the counter in it activated and it starts counting the axles.
- 6) For the existing network the number of cars is 4 and hence the total number of axle is 16, therefore once 16 axles are counted by the counter a control signal is sent to the ATC system.
- 7) The distance between the stations, the gradient of the tracks, angle of track curves, and angle of banking is all programmed in the ATP control circuitry.
- 8) Based on the data coming from the sensors and above mentioned constraints, the ATP system will decide on whether to accelerate, brake or to coast the train.
- 9) Once reaching the station, the train is docked in such a position that the first axle is in touch with the axle counter and accordingly the station indication is shown in the Dynamic Route Map (DRM), announcements are made and then opening and closing of doors.
- 10) Once passengers have boarded the train the doors are closed, and when the train departs after the last axle crossing the axle counters, the same process is repeated again.

These are the sequence of operation that takes place when the train is in Automatic Train Operation mode.

### **4.1 Recommendations for the Chennai Metro System**

While testing the metro train the following observations were made and accordingly suggestions have been provided to the organization for its betterment.



#### **4.1.1 Ventilation and Air Conditioning Unit (VAC)**

In one of the observations it was found that the VAC units of the trains weren't efficient and there was difference in air flow in different cars. Hence the VAC units were checked for its air flow measurements with help of anemometer it was found that the for the existing duct design

the fan was under designed. This caused the difference in air flow in each car. Also its efficiency was about 60% only.

For the existing design the fan was made of 5 leaves / blades and the speed of the motor was about 800rpm. After measurement and arrival of VAC unit validation team onsite the fan design was changed to 6 leaves / blades, and the speed of the motor was replaced with 1400rpm. This change in design is applicable to all the 42 train sets. The given below table shows the air flow measurements and replaced fan units of the train.

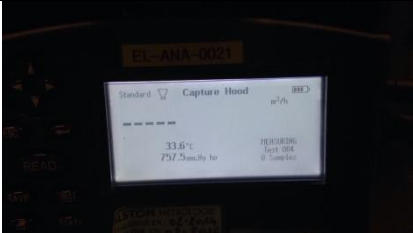
**Table 14: VAC Unit Replacement**

Image	Description
	Air Flow Measurement from the Anemometer indicating the current air flow
	Anemometer for air flow measurements
	VAC unit the train replaced with 6 blades

#### **4.1.2 Single Point Data Collection**

Metro trains, being highly integrated and complex machines are susceptible to minor faults and failures, hence accordingly to make the troubleshooting easier modern day metro trains are provided with data logging systems from which we can find out the type of faults that have occurred in which part of the system.

In metropolis, which is supplied for Chennai metro rail project has data logger too, except that it is not connected with a central point from which it can be accessed. For example, if there is a fault in traction system, then the testing / maintenance engineer will have to request the OCC for

placing the train Inspection Bay Line (IBL), then open the traction system which is beneath the train and then extract the data from it. This process is tedious and time consuming.

In order to overcome this suggestion was made that the train can be equipped with a single point of data extraction, from which all the equipments can be accessed. All the equipments and systems are networked. Hence, if a proper port address for the particular equipment along with its IP address is provided then this single point of data extraction is very much possible and it reduces the time taken for trouble shooting the problem.

## Chapter – 5: CONCLUSIONS

As known to us we can define a Smart Grid as a superimposing of information and communication infrastructure with the electrical infrastructure. On the similar basis if we analyze the systems of the metro trains we can say that it is a superimposed product of electrical, information and communication technologies along with mechanical system. To understand this concept this, the project have been carried out in the domain of testing and commissioning which tells us a clear idea about the various systems onboard the metro trains and how the operation of train is happening in autonomous modes.

According to NIST 7168 the smart grid is defined by the following picture. On the similar basis if we explain the see the systems of a metro train we can see that it also has an electrical system, information and communication systems, along with this it has a mechanical system which makes the train to move.

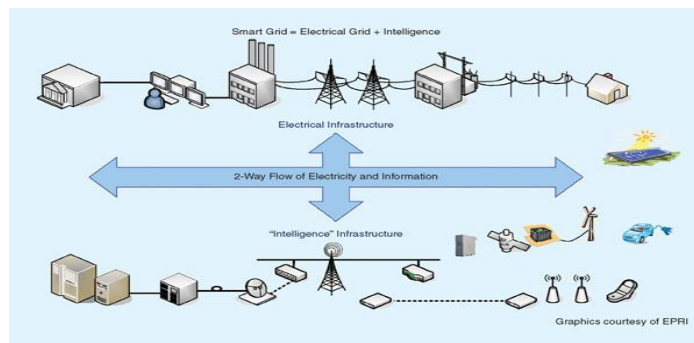



**Figure 34: Smart Grid Definition (Base Line)**

The different systems of the metro train are explained in brief here.

- 1) **Electrical Systems** – It comprises of the overhead power supply from which the train receives the power to move. Along with that it has electrical components such as transformers, vacuum circuit breakers, power supply conversion units for supplying power to auxiliaries, internal power distribution panel, relay arrangements for protection etc.

**Table 15: Electrical Systems of Metropolis**



Image	Description
	<p>Electrical Relay and Switches panel for train operation and protection</p>

	<p>Auxiliary power supply chamber provided with power conversion modules</p>
	<p>Traction power supply and conversion unit</p>





## 2) Information and Communication Systems

Modern metro trains are fully equipped with latest information and communication systems which will ensure the safe functioning of the trains and also it provides safety to the passengers commuting in it. The various communication systems that are on board the trains are the PA-PIS systems, telecommunication interface systems with DCC and OCC, dynamic route map display systems, automatic train operation systems panel which involves many communication with the field sensors deployed on the stations and tracks, event recorders, network video recorders, on board processing systems etc. The metropolis series is mostly controlled by software. This accounts to the IT systems on board. The equipments of the train is all connected and controlled by CAN and MVB bus networks. This will majorly account for the communication systems on board.

**Table 16: Information and Communication Technologies**

Image	Description
	<p>Onboard main processing unit (MPU), which is responsible for all the logical decision for train functioning</p>
	<p>Multiple Vehicle Bus (MVB) Controller card responsible for TCMS, ACE, BCE communication to ATO System and MPU</p>





	<p>Controller Area Network (CAN) card responsible for communication of electronic door control units of all doors, ventilation and air conditioning(VAC) units</p>
	<p>A-Gate controller card – Embedded card responsible for control action for all the auxiliary supply systems power conversion, traction power conversion system and firing of IGBT.</p>
	<p>Propulsion Control Electronics (PCE) – software installation for traction control system of the Train</p>
	<p>Event Recorder and Network Video Recorder Systems – Onboard IT Systems of the train</p>
	<p>List of software that is installed for the train operation. Software is for DCU, PCE, ACE, VAC, MPU, DDU, UMC, and ATO.</p>

### 3) Mechanical Systems

This accounts to the overall parts of the train. This includes parts such as traction motors, doors, braking systems, car body, axle, pneumatic systems etc. This in combination with the other systems will make the train move.

**Table 17: Mechanical Systems**

<b>Image</b>	<b>Description</b>
	Car Body
	Pressure Vessel – From this pressure is supplied to braking systems of the train

From the above mentioned procedures for testing various equipments of the trains, understanding the different systems that are on board the metro trains is similar to that of the system that will comprise the smart grid.

Hence from this we can conclude that all the metro trains and the other transportation systems which use electricity for its propulsion can be called as a mini smart grid which is on the move.

## **REFERENCES**

1. Pre-FDR bogie-2011-10-31 – “Train Bogie” – ALSTOM Transport India, 2015
2. Pre-FDR\_Chennai\_Auxiliary\_Converter – “Shore Supply Unit”, ALSTOM Transport India, 2015
3. Pre-FDR\_Door system\_Chennai – “Door Control Systems”, ALSTOM Transport India, 2015
4. Pre-FDR Chennai - HVAC System – “Ventilation and Air Conditioning Unit”, ALSTOM Transport India, 2015
5. Pre-FDR\_Lighting system\_Chennai Metro – “Lighting Systems”, ALSTOM Transport India, 2015
6. PA-PIS - Pre-FDR\_CHENNAI\_v1 – “Passenger Announcement and Passenger Information Systems”, ALSTOM Transport India, 2015
7. Pre-FDR\_CHENNAI TCMS & software quality –“ Train Control and Management Systems”, ALSTOM Transport India, 2015
8. Pre-FDR Chennai Traction – “Traction Systems”, ALSTOM Transport India, 2015
9. “AC Traction Manual” – Indian Railways, 1970
10. “Signaling Operation and Maintenance Manual” – Indian Railways, 1970
11. <http://chennaiemtorail.gov.in/metro.php>
12. SPPA001.87.447 REV.12 – “Testing Procedures” – ALSTOM Transport India, 2015
13. PT 06.32.007 rev03 - Routine Dynamic Test