

REJUVINATING SELF DRIVEN VEHICLE FOR MOBILITY IMPAIRED PERSON

By

Vaibhav Kulkarni

R109231010

M. Des. – Transportation Design
(2013-15)



School of Design Studies

University of Petroleum and Energy Studies

Dehradun

April 2015

**REJUVINATING SELF DRIVEN VEHICLE
FOR MOBILITY IMPAIRED PERSON**

Project submitted in partial fulfillment of the requirements

For the award of the Degree of

MASTER OF DESIGN

IN

TRANSPORTATION DESIGN

Under the guidance of

Manas Ranjan Mishra
Head of Department
School of Design Studies
UPES, Dehradun

By

Vaibhav Kulkarni
Enrolment No. R109231010
SAP ID: 500028551



Declaration

I hereby declare that the project work entitled “Rejuvenating Mobility for Mobility Impaired Person” submitted by me in partial fulfilment of the requirements for the award of the degree of Master of Design (Transportation Design) at School of Design Studies, University of Petroleum and Energy Studies was carried out by me during 15 Jan 2015 to 16 April 2015.

Date: 20/04/15

Sign:

Place: Dehradun

Name: Vaibhav Kulkarni

SAP ID: 500028551

ACKNOWLEDGEMENT

I take this opportunity to express my sincere gratitude to **Mr. Atul Kedia**, for his whole hearted support in completing this project.

I also thank my internal guide **Mr. Manas Ranjan Mishra** , Head of the Department, School of Design Studies, UPES for his valuable guidance and constant encouragement throughout the course of this project.

I also thank Dr. Kamal Bansal, Dean, COES, UPES for all the encouragement and support for this project.

I also thank Mr. Ashish Deshpande, Mr. Anand Palsodkar from Elephant Strategy + Design, Pune for their support during the entire endeavor.

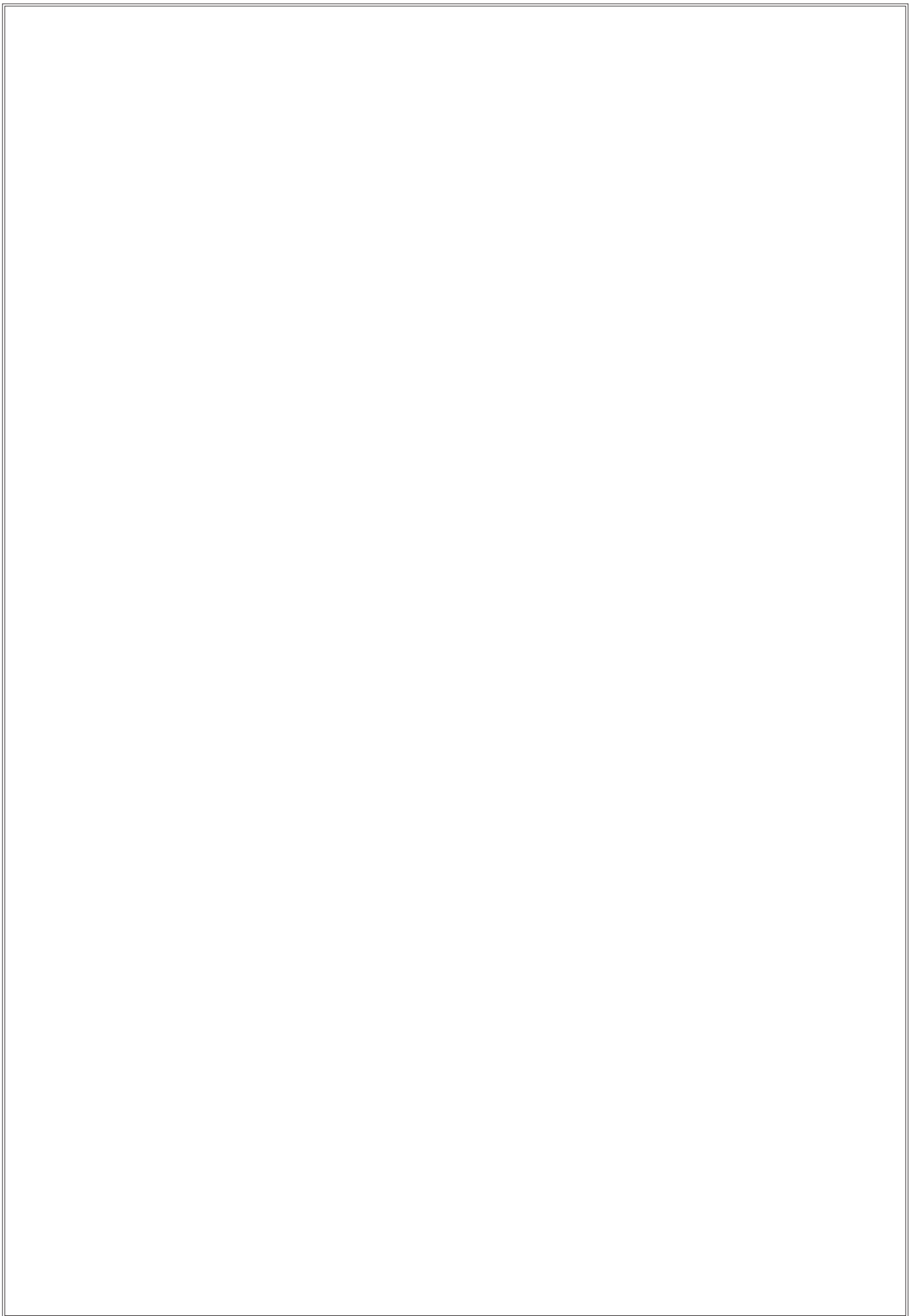

ABSTRACT

The objective of a project is to design a mode of a transportation for mobility impaired person. The conveyance which reduce efforts and support them to carry out day to day commute.

Study the modest solutions that are used at present and understanding their operation. Also studying lifestyle of a mobility impaired person and providing affordable solution.

MOBILITY

The meaning of Mobility varies from person to person: Physical mobility, social independence, flexible lifestyle, etc. This also applies to people who are dependent on devices or products to aid mobility. These mobility aids should be functional, in context with their usage to help the users cross boundaries and offer independence with dignity.

The mobility devices mainly available to the physically challenged are:

- Wheelchair for indoor use
- Tricycle for outdoor use

In current scenario most wheelchairs, tricycles available are manufactured and distributed by NGO's.

There have been lot of innovations and variations in the wheelchair designs. Wheelchairs are available for all kinds of different purposes but the tricycle design has still remained the same. The tricycle design is just an extension of a bicycle with reinforcements and additional utility components.

The tricycle designed for ease of manufacturing and affordability, little attention is paid to comfort, ergonomics and the environments in which it is to be used.

There are no products available to aid mobility both indoors and outdoors in India.

There is a certain stigma attached to the tricycle as it has been poor man's mobility aid on the road.

People often refer to the tricycle user as a beggar; it is most commonly used by people with lower income groups and not by the middle or higher income groups. In west tricycles are used primarily for recreation, shopping and exercise. Tricycles are favoured by children and senior citizens alike for their apparent stability versus bicycle. The tricycle has gone various transformations in west as per the change in usage.

A Tricycle must meet the user's individual needs and environmental conditions, provide postural support, and are safe and durable. The tricycle must be available at affordable cost, should be maintainable and sustainable in the country of use. This is not always easy, because users are a diverse group with different requirements and environmental and socioeconomic conditions.

To study the diverse group of users a user survey was carried out in various parts of the country.

The problem areas were identified after interviewing the users, parents and caretakers along with the manufacturing and distribution of the tricycle.

Considering the socioeconomic structure of the users the scope was narrowed down to manual Tricycle with a possibility to be converted to into a motorized tricycle.

A tricycle is defined as appropriate when it:

- Meets the user's needs and environmental conditions;
- Provides proper fit and postural support;

- Is safe and durable
- Is available in the country
- Can be obtained and maintained and services sustained in the country at an affordable cost.

Factors considered in tricycle design:

- Users health, Safety
- Ergonomics
- Environment: home, work (indoors, outdoors)
- Manoeuvrability
- Other functional features: ability to aid transfer, portability
- Seating system
- Components
- Stability
- Postural support
- Strength, durability
- Gender issues
- Manufacturing
- Cost effective
- Material, finishes, upholstery, colour
- Adaptations required if any

INITIAL SCOPE

Initial design brief

To design self driven vehicle for mobility impaired person to ease routine commute.

Scope

The objective of a project is to design a mode of a transportation for mobility impaired person. The conveyance which reduce efforts and support them to carry out day to day commute.

Study the modest solutions that are used at present and understanding their operation. Also studying lifestyle of a mobility impaired person and providing affordable solution.

For the initial project proposal study was done on the existing mobility solutions available for the mobility impaired persons. It involved interaction with the user and their families, the mobility aid manufacturers and suppliers. The user survey and market survey was conducted in the three different cities- Dehradun, Pune, Mumbai to understand the broad pattern of usage among various levels in the society.

The user survey helped in understanding various indigenous methods of mobility used in the various parts of the country along with manufacturing and the distribution.

Research methodology

➔ Field research

Observation
Participative
Non participative

➔ First hand data collection

Interviews
Questionnaires

➔ Secondary data collection

Literature review
Standards and norms
Internet research

➔ Audit

Product
Service
Infrastructure

➔ Existing system model study

Study of existing products
services, organizations etc.
related to physically challenged

Data interpretation and analysis

Organisations Visited

Intent Of Visit

1. Paraplegic Rehabilitation Centre, Pune	User survey
2. Harbans Cycle Industries	Study tricycle manufacturing
3. Scope T& M	Study electric wheelchair manufacturer
4. Fellowship for Physically Handicapped, (FPH), Mumbai	Study tricycle manufacturing, User survey
5. National Society for Equal Opportunities for Handicapped (NASEOH), Mumbai	Study tricycle manufacturing, User survey
6. Ekansh Trust, Pune	User survey
7. Cheshire Disability Trust, Dehradun/ Mumbai	User survey
8. Other	User survey

Places visited

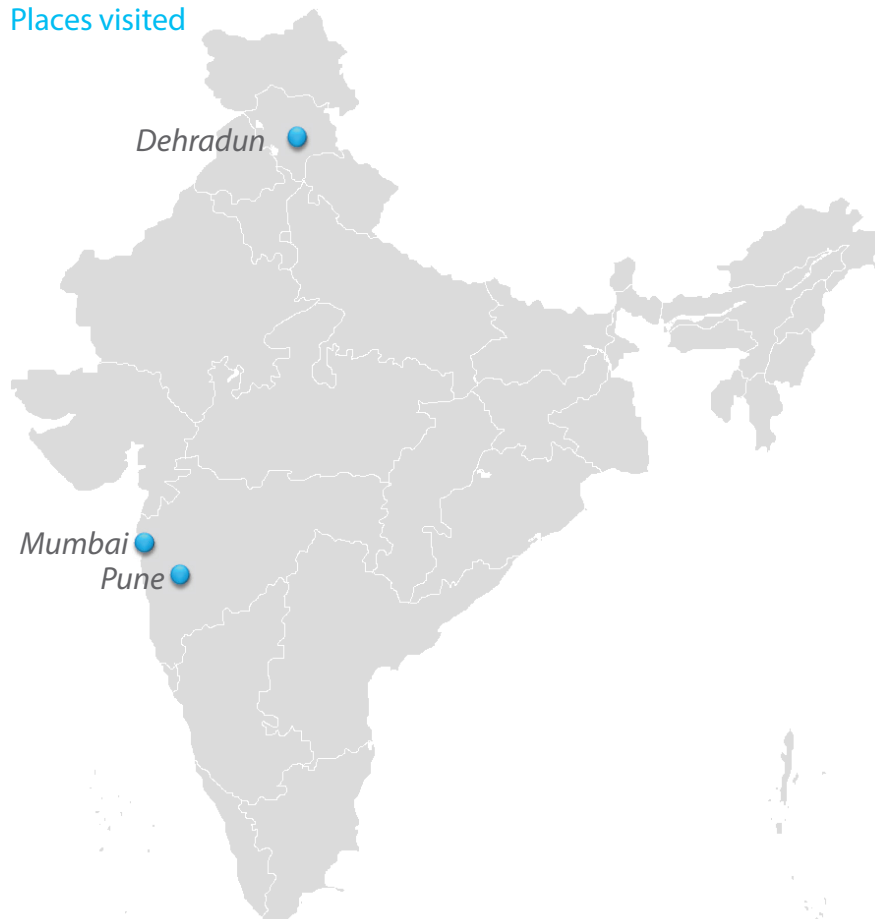

TABLE OF CONTENTS

SR. NO. CONTENTS	PAGE NO.
1.0 INTRODUCTION	12
2.0 DATA COLLECTION	15
2.1 DISABILITY STATISTICS	16
2.2 DEFINING DISABILITY	18
2.3 REHABILITATION	21
2.4 ASSISTIVE DEVICES	22
Assistive Devices For Mobility	
Adaptive Mobility Devices	
Ground Mobility Device	
2.5 WHEELCHAIR	25
Anatomy Of Wheelchair	
History Of Wheelchair	
Wheelchair Design Today	
Types Of Wheelchair	
Wheelchair Accessories	
Wheelchair Transfer	
Wheelchair Design	
2.6 TRICYCLE	51
History Of Wheelchair	
Hand Pedalled Tricycle	
Types Of Tricycle	
2.7 USER SURVEY AND ANALYSIS	61
3.0 REDEFINE BRIEF	79
3.1 BRAINSTORMING	81
3.2 PROJECT SCOPE	82
3.4 MATERIALS	83
3.5 USER PERCEPTION	84
3.6 MOOD BOARD	85
3.7 ANTHROPOMETRIC DIMENSIONS	86

TABLE OF CONTENTS

SR. NO. CONTENTS	PAGE NO.
4.0 CONCEPT SKETCHES	88
4.1 FRAME OPTIONS	98
4.2 DETAIL SKETCHES	103
5.0 DIGITAL MODEL	107
6.0 CONCLUSION	118
REFERENCES	120
BIBLIOGRAPHY	121

INTRODUCTION

The final project is the culmination of a professional education program in design. The project can be an industry sponsored project where the student formulates one's own design brief or work with a client defined brief. It aims at sensitizing a design student to the needs of the users and the industry.

It serves as an opportunity to put the acquired skills to test as the student prepares to embark upon a professional career. It gives the student industry exposure and firsthand experience of the design process followed in the particular industry along with self learning.

With guidance from the institute and the various experts in the industry one can relate theory to practice, classroom to industry and take in the lessons industry has to offer.

Also it helps the student realize one's own interest, strengths and potential which helps in preparing to enter the professional world of design.



ABOUT THE INSTITUTE

Indian School of Petroleum and Energy was established in 2001 and University of Petroleum and Energy Studies in 2003. Both institutions were conceived and established through the contributions of industry captains and leaders, active support and encouragement from the industry players and the academic experts taking the challenge to transform education by making it futuristically relevant to the industry.

School of Design Studies (SoDS) was established under the bigger umbrella of University of Petroleum and Energy Studies (UPES).

With the increasing focus on innovation and creativity and exemplary vision on future of design, UPES established the School of Design Studies (SoDS) keeping in view the requirement of commercially viable and technically advanced designs.

School of Design Studies provides creative design courses that help students understand and master visual design aspects of transportation, industrial and product development and build a successful career in the industry of various choices.



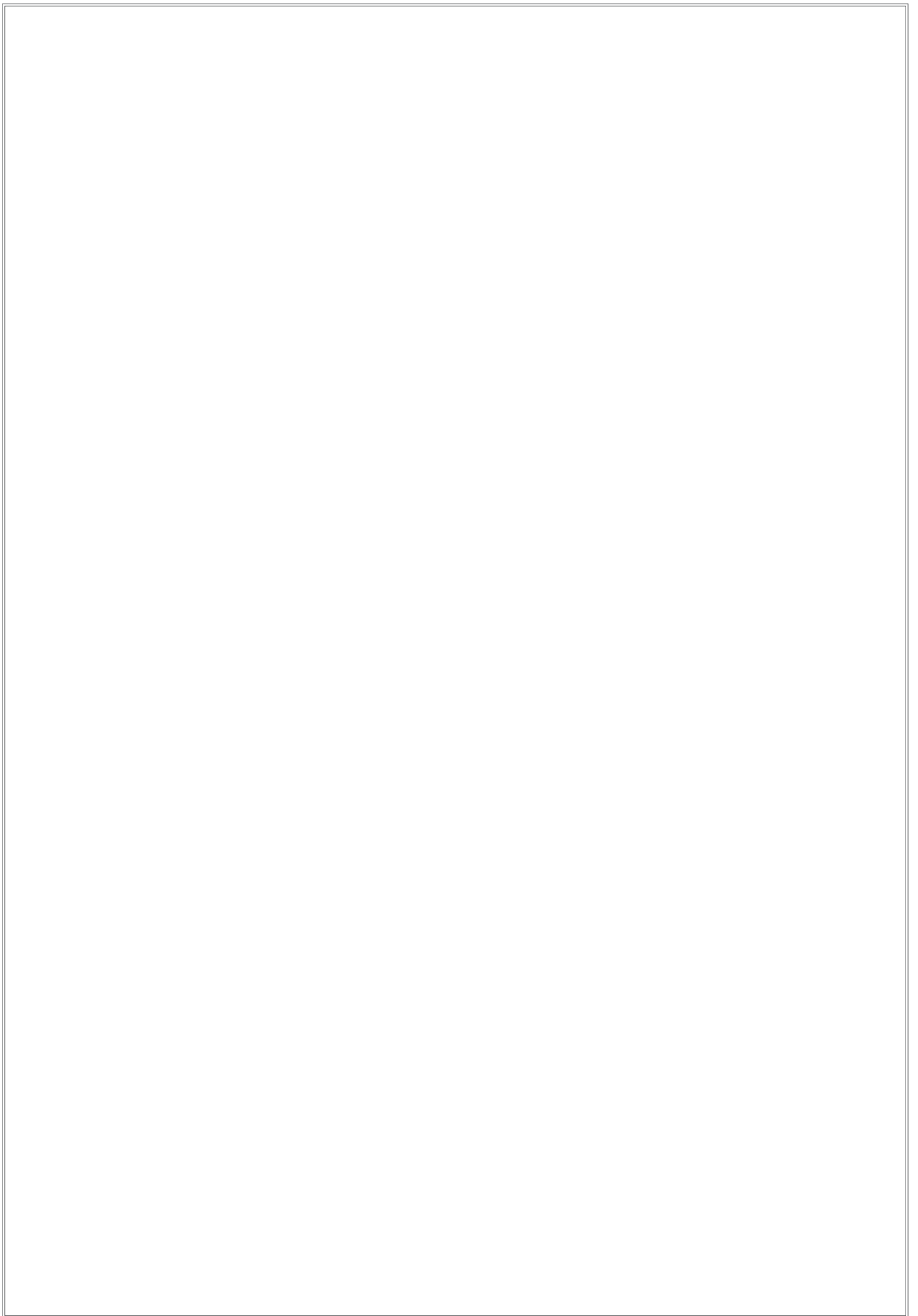

DATA COLLECTION

DISABILITY STATISTICS

The disability data indicates that the mobility challenged population is more than any other type of disability (20.3 %) and need to be addressed by providing mobility aids that are appropriate to the users.

- The disability in seeing and hearing is more among females.
- Disability in movement is more among males

Disabled Population by Type of Disability India, 2011

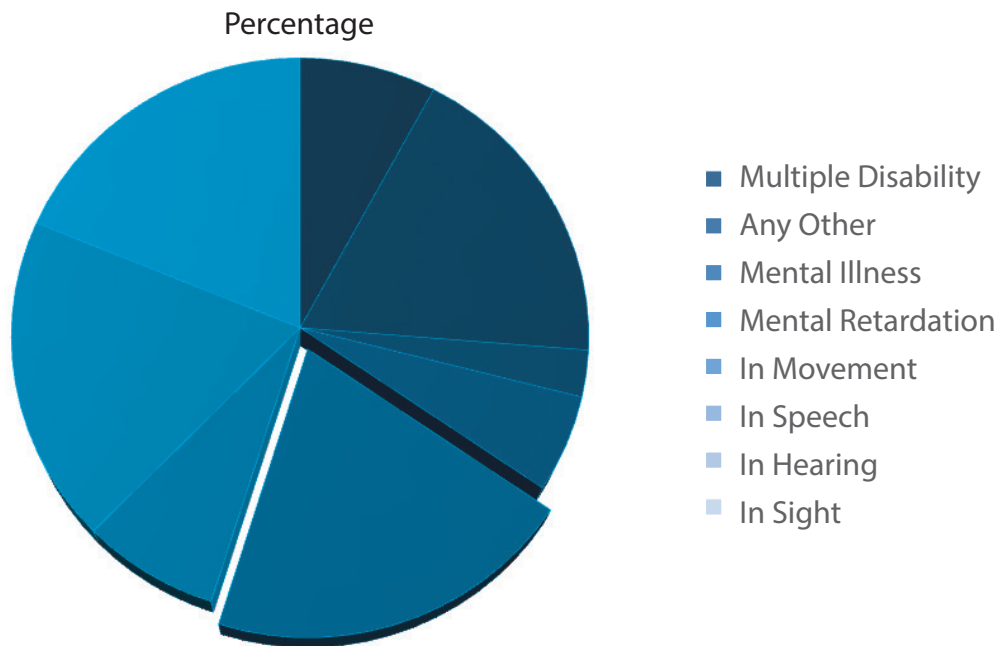

Disabled Population by Type and Sex India, 2011

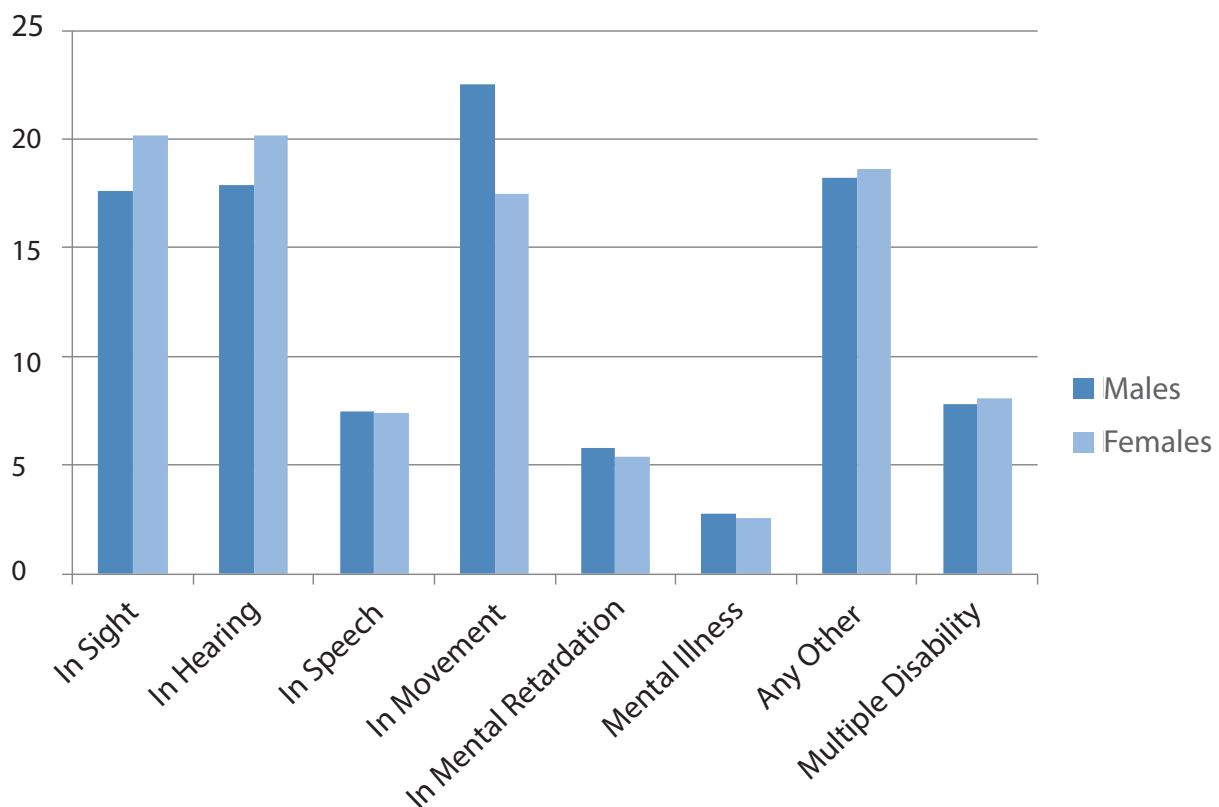

Disability Data

Disabled population by the type of disability (details in lakhs), India 2011

Disability Census in lakh (Percentage)

Type of disability	Persons	%	Males	Females
Total	268.10	(100%)	14,986,202	11,824,355
In Seeing	50.32	(18.8%)	2,638,516	2,393,947
In Hearing	50.71	(18.9%)	2,677,544	2,393,463
In Speech	19.98	(7.5%)	1,122,896	875,639
In Movement	54.36	(20.3%)	3,370,374	2,066,230
Mental Retardation	15.05	(5.6%)	870,708	634,916
Mental Illness	7.22	(2.7%)	415,732	307,094
Any Other	49.27	(18.4%)	2,727,828	2,199,183
Multiple Disability	21.16	(7.9%)	1,162,604	953,883

(Source: Census-2011)

DEFINING DISABILITY

A state in which the individual experiences a limitation of ability for independent physical movement

Alteration in mobility may be a temporary or more permanent problem. Most disease and rehabilitative states involve some degree of immobility, as seen in strokes, leg fracture, trauma, morbid obesity, multiple sclerosis, and others. With the longer life expectancy for most Americans, the incidence of disease and disability continues to grow. And with shorter hospital stays, patients are being transferred to rehabilitation facilities or sent home for physical therapy in the home environment.

Mobility is also related to body changes from aging. Loss of muscle mass, reduction in muscle strength and function, joints becoming stiffer and less mobile, and gait changes affecting balance can significantly compromise the mobility of elder patients. Mobility is paramount if elder patients are to maintain any independent living. Restricted movement affects the performance of most activities of daily living (ADLs).

Elderly patients are also at increased risk for the complications of immobility. Nursing goals are to maintain functional ability, prevent additional impairment of physical activity, and ensure a safe environment.

Causes of Disability (affecting mobility)

- Spinal Injury

Injuries to the spinal cord cause different types of mobility impairments, depending on the areas of the spine affected.

Quadriplegia refers to the loss of function to arms, legs, and trunk. Person with quadriplegia have limited or no use of their arms and hands and often use motorized wheelchairs.

Paraplegia refers to the loss of function to the lower extremities and the lower trunk. People with paraplegia typically use a manual wheelchair and have full movement of arms and hands.

Tetraplegia is much more serious, since the damage to the spinal cord is higher up at the neck level and all the four limbs and possibly the lungs will be affected.

- Amputation

Amputation is the removal of one or more limbs, sometimes caused by trauma, malignancies or other conditions.

- Arthritis

It is the inflammation of the body's joints, causing pain, swelling and difficulty with mobility.

- Back disorders

They can limit a student's ability to sit, stand, walk, bend, or carry objects. They include, but are not limited to, degenerative disk disease, scoliosis, and herniated disks.

- Scoliosis

It is abnormal curving of bones that make the structure surrounding spinal cord.

- Cerebral palsy

It is the result of damage to the brain prior to or shortly after birth. It can prevent or inhibit walking, and cause a lack of muscle coordination, spasms, and speech difficulty.

- Neuromuscular disorders

It includes a variety of conditions, such as muscular dystrophy, multiple sclerosis, and ataxia, which result in degeneration and atrophy of muscle or nerve tissues.

- Fibromyalgia

Is a form of “soft tissue” or muscular rheumatism causing constant pain in muscles

- Spina bifida

Is a birth defect in which parts of bones that make up the structure surrounding the spinal cord do not come together properly.

- Muscular Dystrophy

It is a neuromuscular disease caused due to disorder of central nervous system involving one or many parts of the motor units. Muscular weakness is the major cause of the disability. It is a degenerative condition but it is essential to keep the child mobile & active. The progress of the disease is fairly predictable. By the time the child is 8 or 9, he will be showing marked curvature of spine & will probably use the ‘toe’ walk. Between 8 and 11, he may have to start using a wheelchair. Hands are usually affected after the legs, but gradual loss of movement will be experienced. Between the ages of 16 and 25, deterioration may also affect the muscles of the face, hands and respiration, and the adolescent is exposed to infections and strain on heart. In the final stages, the child will require 24 hours attention.

- Multiple Sclerosis

It affects older adolescents and adults: it is a disease of the central nervous system, which affects the nerve fibres.

- Poliomyelitis

Polio is regarded as one of the few success stories amongst the major handicapping conditions affecting the central nervous system.

Development of vaccine in 1960 has ensured that the children (in theory at least) can now be totally protected. Better hygiene and sanitation in western countries have eliminated most potential breeding grounds for the virus.

However, with air travel and increased world mobility, it is still possible to be exposed to infection, reluctance to take vaccination.

The majority of current polio victims suffering from a handicapping degree of paralysis are adolescents and young adults. It is not a progressive condition and the major practical problem lies in the adjustment to a severe degree of disability.

- Friedreich's Ataxia

It is a hereditary disease of central nervous system, starts in childhood or adolescence. In early stages child will show slight unsteadiness in walking followed by increasing awkwardness & clumsiness of hands & difficulties in manipulation which becomes progressive over years. Vision & hearing is unaffected, but speech can become indistinct and slurred. There is no treatment, but physiotherapy can play a useful (if limited) part in maintaining mobility & helping with adjustments to everyday life.

- Haemophilia

It is a relatively rare condition (one in every 25,000), it is a disorder of the normal clotting mechanism of blood, genetically transmitted through both sexes but commonly affecting only men. Children affected by haemophilia will never need a wheelchair however severely affected suffer haemorrhages into muscles & joints which are acutely painful, potentially crippling. Knees, elbows, & ankle joints are commonly affected, in many cases child will have to rest in bed with the limb immobilised.

- Amelia of dysmelia

Abnormality resulting in the absence or shortening of a limb. As congenital defects of this kind are comparatively rare, it is unlikely that a good service for the artificial limb or appliances needed can be obtained outside a specialist centre. Wheelchair children with limb deficiencies will normally be affected in the lower limbs and may be able to crawl or move themselves around shuffling movement. Many of the severely affected children will have to use a wheelchair for part of the time, particularly outdoors.

- Mental Handicap

Majority of mentally handicapped children are in no way physically handicapped. But those who are multiply handicapped will usually be brain damaged during or shortly after birth. Most of these children will not become independently mobile, and their use of a wheelchair will be dependent upon an assistant to push. Powered wheelchair require a degree of skill to operate them successfully, although some children will manage to use them to a limited extent.

REHABILITATION

Rehabilitation is a process aimed at enabling patients to reach and maintain their optimal physical, sensory, intellectual, psychological and social functional levels. Rehabilitation provides people with disabilities the tools they need to attain independence and self-determination.

Most of the estimated 650 million people living with disabilities around the world lack access to appropriate medical care and rehabilitation services, especially those living in low- and middle-income countries. As a result, people with disabilities experience greater challenges in attaining and maintaining maximum independence and health. Lack of services creates a barrier to full inclusion and participation in all aspects of life.

- Physical medicine and rehabilitation (PM&R)
- Emotional rehabilitation
- Community-based rehabilitation (CBR)

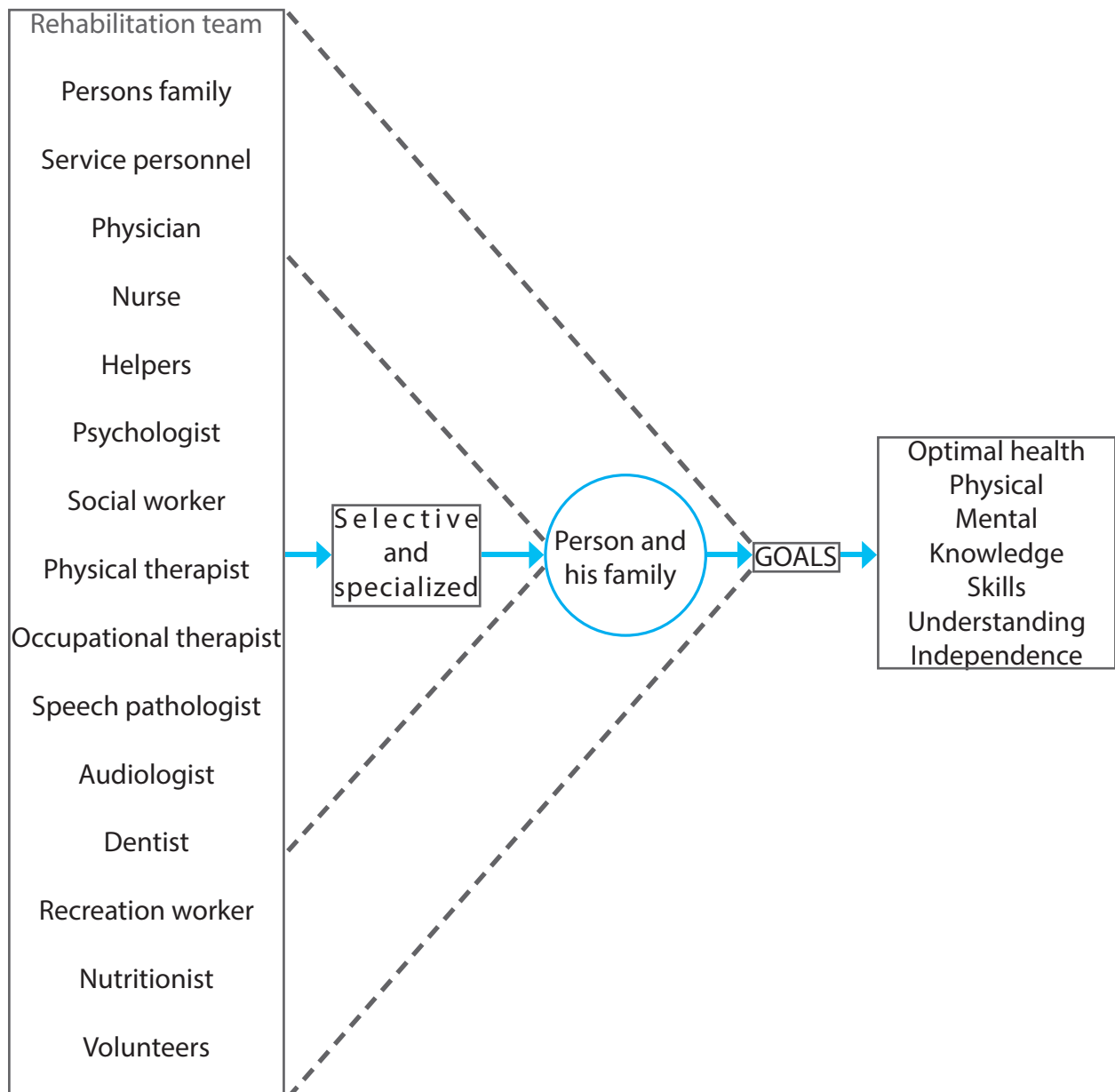

ASSISTIVE DEVICES TO AID MOBILITY

Assistive devices and technologies are items that enable people with disabilities to participate in activities of daily living, helping ensure equal opportunities. It levels the playing field between disabled and the able-bodied counterparts. Many of these devices can be inexpensive, easy to use and can seamlessly interface with one's environment, blurring the lines between disabled and able-bodied.

These includes standing/walking aids, transfer aids, stair lifts, walkers, scooters, wheelchairs , adapted bikes, trikes, car seats/bed, stretchers, patient chairs, ramps, recliners, strollers, patient and wheelchair lifts, wheelchair loaders/carriers, wheelchair restraint systems, etc.

Common sub-categories include

Vehicle Conversions

Includes car-top carriers, custom cars and vans, adaptive driving control, hand-controls, child restraint systems, ramps, lifts, etc..

Ambulatory Aids

Includes canes, cane accessories, crutches, walkers, walker accessories, etc.

Scooters and Power Chairs

Wheelchairs



Walking stick, crutches



Adult walking frame



Manual wheelchair



Wheelchair lift



Mobility scooter



Toilet wheelchair



Stretcher wheelchair



Sports wheelchair



Motorized wheelchair



Motorized scooter



Modified scooter



Modified car

ADAPTED MOBILITY DEVICES

Many times the most efficient and inexpensive mobility solution is "homemade." What can provide the best support while allowing the user to participate in his world to the fullest extent possible, are ideas to be considered while thinking about mobility solutions.



Kids walking frame by:
Don Caston

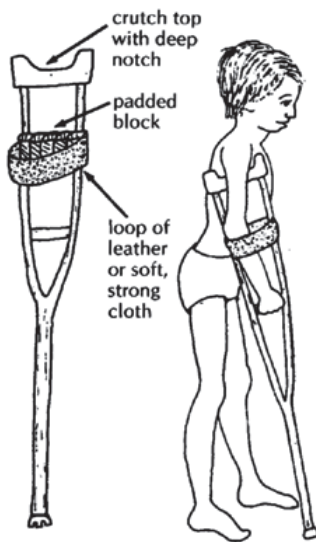

Crutches



Scooter board

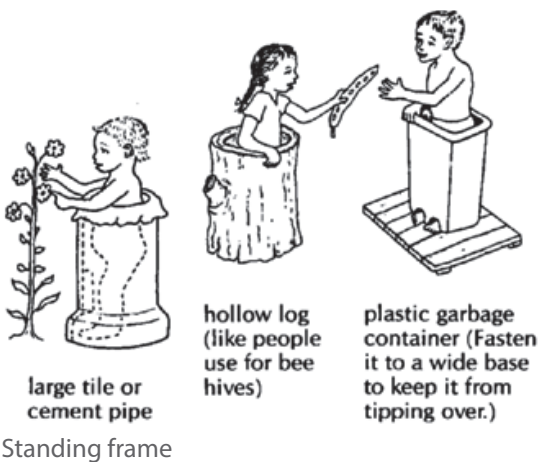

GROUND MOBILITY DEVICE

Purpose

A ground mobility device/ chariot provides an alternative way for a disabled person to move inside and close to home. As the seat is close to the ground it eliminates the need to change the environment to a wheelchair height. This design will help the person to:

- Move from one place to another independently;
- Perform activities at ground height (e.g., eating with the family, sweeping, school work, child care, cooking, washing dishes);
- Carry items (e.g., water bucket, children).

Who can use this device?

For people with old or new injuries to their legs (e.g., polio, amputations, spinal cord injuries); People with long or short term difficulties, children, adults, women - men or the aged with good upper body strength.

It can be used in communities where activities are performed on or close to the ground, indoors - outdoors, urban or rural areas; at home, school, or at work.

Other features

- Push handles
- Seat belt
- Back cushion, extra back or side support
- Seat cushion
- Leg extension
- Larger or smaller seating area
- Motorised version weaving and one castor wheel.

Options for pushing

- Hands on wheels;
- Hands on rim;
- Hands on pegs.
- Design with jute or plastic weaving and one castor wheel.

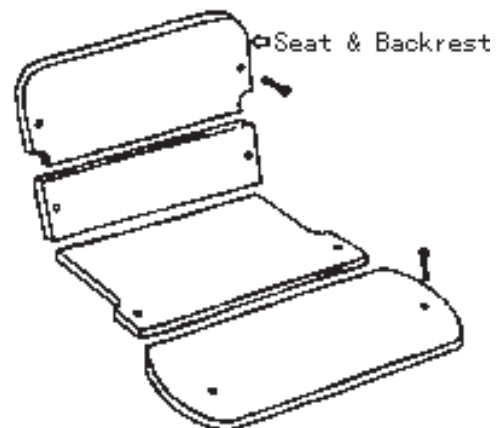
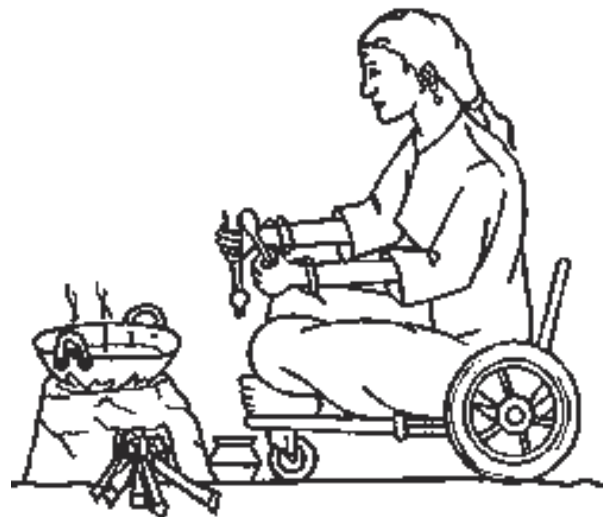
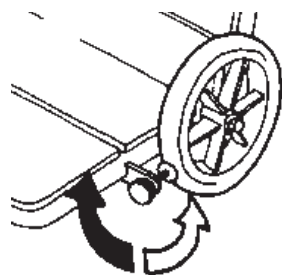
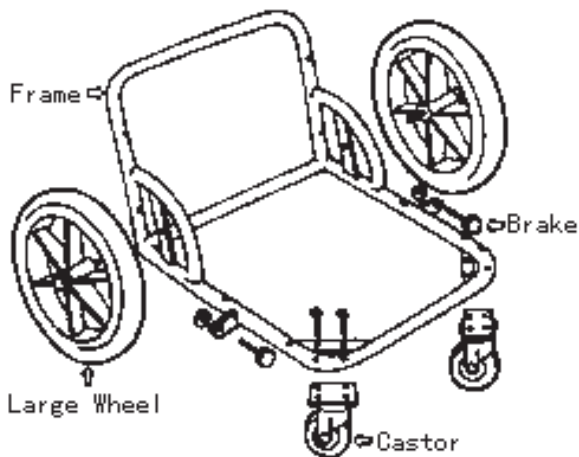

http://hcdg.org/ground_mobility.htm

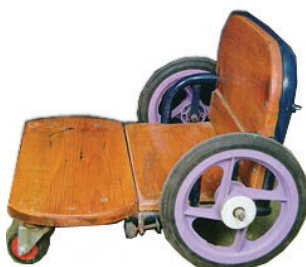

Manual ground mobility device
http://hcdg.org/ground_mobility.htm



Motorised ground mobility device
<http://www.callidai.com>

WHEELCHAIR



WHEELCHAIR

The wheelchair is one of the most commonly used assistive devices by people for whom walking is difficult or impossible, due to illness or disability for enhancing personal mobility, which is a precondition for enjoying human rights and living in dignity and assists people with disabilities to become more productive members of the community.

Wheelchairs can be roughly categorized into manual and motorized or powered. Wheelchair designs vary to enable users to safely and effectively use their wheelchair in the environment in which they live and work.

WHEELCHAIR

Wheelchair designs vary to enable users to safely and effectively use their wheelchair in the environment in which they live and work.

Types of Wheelchair

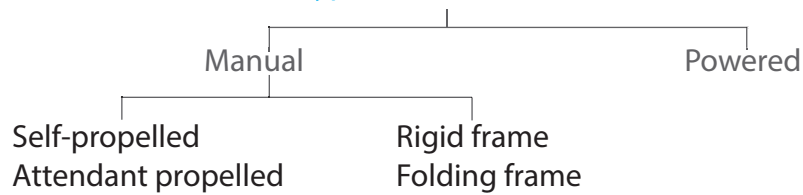

Indoor
Outdoor
All terrain

Quick release wheels
Detachable wheels

Temporary use
Long term use
Postural support

➔ Other wheelchair variants

Standing wheelchair
Mobility scooter
Bariatric wheelchair
Paediatric wheelchair
Knee scooter

➔ Sports wheelchairs

Power chair football/ power, soccer
Transfer, stretcher or mechanical chairs
Beach wheelchairs

➔ Transfer wheelchairs

Transfer, stretcher or mechanical chairs

Appropriate wheelchair

A wheelchair is appropriate when,

- It meets the user's needs and environmental conditions
- Provides proper fit and postural support
- Is safe and durable
- Is available in the country
- Can be obtained, maintained, services sustained in the country at most economical & affordable price.



ANATOMY OF WHEELCHAIR



Self-propelled, foldable, manual wheelchair

cnwheelchair.com

HISTORY OF WHEELCHAIRS

The chair and the wheel are two of mankind's oldest inventions. The first image that is documented of furniture on wheels was found on a Greek vase in 530 B.C. The picture was of a child's bed on a set of four wheels, giving the image of attaching wheels to furniture.

After which evidence was found of a chariot on spoke wheels in China in 1300 B.C, but in 525 A.D, an engraving of a representation of a wheelchair was discovered, this is the earliest impression found of a wheel chair to date.

Wheel chairs were originally referred to as 'invalids chairs' and in 1554 one of the first wheel chairs was made by Jehan Lhermite for Phillip II of Spain. It was constructed of iron, leather and wood, and featured footrests. An artist sketched the king sitting in this wheelchair in 1595.



Image on Greek vase of wheeled child's bed



525 A.D. engraving of one of the earliest representations of a wheeled chair



King Phillip II (1595) of Spain on his rolling chair with foot rest



Paraplegic watchmaker, Stephen Farler (1655) built his own chair at 22 yrs of age

Later on in 1655 a disabled British watchmaker called Stephen Farler built himself a three-wheeled chair to help himself get about on. Unlike earlier wheelchairs, which had to be pushed by another person, this one was made to be moved by the occupant. It was boxy, with two back wheels and one front wheel. The rider turned two levers, one on each side of the front wheel, to move the chair.

In 1881 the 'push rim' was invented which meant no more dirty hands for wheelchair users, a smaller circular steel tube was attached to the wheel. They could use the push rim to move the wheels and not get covered in mud. A smaller circular steel tube was attached to the rear wheel. This circular tube, made turning the wheel easier, because the user could grab the tube instead of directly grabbing the wheel. Push rims became standard and provided a better means of spinning the wheel.

In 1783, John Dawson invented the Bath chair, so named because it was used to transport disabled bathers to and from the spas in Bath, England. It was made in a number of styles, some open and others enclosed. The occupant steered it with a handle, but the Bath chair had to be pushed by an attendant.

Comfort for the disabled person became more of an issue, so in 18th century a convertible chair with reclining back and adjustable foot rests was made.

Through the 19th century, wheelchairs were mostly made of wood, with wicker backs and seats. The wheels were made increasingly larger, however, and riders began to push themselves by turning the wheels. From wheel chairs came the invention of powered chairs and mobility scooters, which takes the basic concept of the wheelchair but instead of it being self propelling



"Bath" chair

the chair is moved forward by electricity and power. The first motorized wheelchair was invented in 1916, but as they are expensive manual wheel chairs were still the more popular choice. The powered chairs were also very heavy and so were hard to move about. Until the 1930's, the wheelchair was a rather cumbersome device. They were bulky and while a lightweight wicker wheelchair had been built, even this could not be easily transported; making travelling very difficult for many wheelchair users. In 1933 Harry Jennings invented a lightweight steel powered wheelchair. He invented this because his friend was caught in a mining accident that broke his back and he had to use a heavy and non-foldable wheelchair as that was all that was available.

Jennings was a mechanical engineer and after hearing his friend complain so much about the wheel chair set to work on inventing a lightweight and folding wheelchair. After he had invented the chair the two friends saw the potential in the business and set up the mass-manufacturer international company Ernest and Jennings.

About twenty years after the invention of the E & J wheelchair, the first electric wheelchair was built. This chair utilized the E & J frame, outfitting it with an electric motor. A simple hand control was mounted on the handle bar of the chair. New control methods were also created at this time, including those that relied on head movements to control the chair. As the popularity of this first electric wheelchair began to unfold, many companies began selling converter kits that allowed an existing E & J wheelchair to be made electric.

Today, there are many electric and manual wheelchairs to choose from. Many off road and alternative wheelchairs are available. These chairs have changed a good deal since the early Greek wheeled vehicle, but many of these early wheelchairs helped to mold the wheelchair of today.

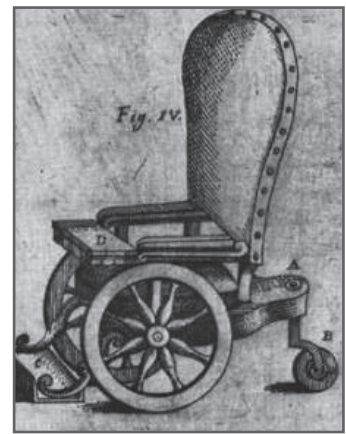

18t century seating

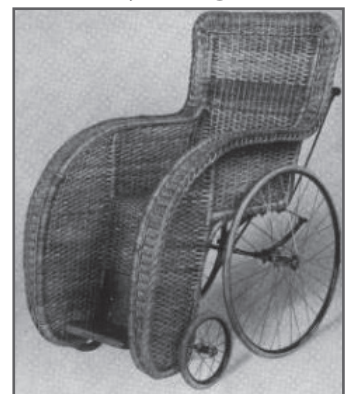

Indian reed light weight wheelchair



First folding metal wheelchair

Wheelchair Timeline

4000 B.C.	Man's two earliest inventions: Chair and Wheel Eastern Mediterranean basin
1300 B.C.	Spoked wheels on chariots it is the oldest evidence of wheeled chairs, China
530 B.C	First record of combining wheels to furniture Image on Greek vase of wheeled child's bed, Greece
525 A.D	engraving of one of the earliest representation of a wheeled chair, China
3rd century	Wheel barrow: Used for moving sick or disabled to "Fountain of Youth", China
1553	Greek and Roman physicians prescribed a "gestation" or transportation for the sick or disabled Get into fresh air and help work with whatever they could do in the fields. Carried on a sedan or push on a chair with wheels, Europe
1595	King Phillip II of Spain Had his own rolling chair with foot rests
1655	Self propelled chair-Paraplegic watchmaker, Stephen Farfler built his own chair at 22 yrs of age.
1783	Bath Chair- Bath, England Invented by John Dawson, "Wheel-chair maker" 1783 Dominated the market of 19th century Two large wheels, one small wheel
18th century	Comfort for the disabled person became more of an issue Convertible chair (reclining back and adjustable foot rests)

images: wheelchair.net

WHEELCHAIR DESIGN TODAY



i-real Toyota



i-unit Toyota



ibot DEKA



Balanced sports wheelchair



HELLO Honda Electric mobility Loop



MIO Suzuki Motor



Wheelchair bikes



Speedy Electra



TYPES OF WHEELCHAIRS

Manual wheelchairs

Manual wheelchairs are those that require human power to move them. Many manual wheelchairs can be folded for storage or placement into a vehicle.

Manual wheelchairs can be self-propelled and attendant propelled. Which can be further categorized into rigid or folding according to the structure of the frame.

Powered/ motorized wheelchair

A motorized wheelchair, power chair, electric wheelchair or electric-powered wheelchair (EPW) is a wheelchair that is propelled by means of an electric motor rather than manual power. Motorized wheelchairs are useful for those unable to propel a manual wheelchair or who may need to use a wheelchair for distances or over terrain which would be fatiguing in a manual wheelchair. They may also be used not just by people with 'traditional' mobility impairments, but also by people with cardiovascular and fatigue based conditions. An electric-powered wheelchair is a wheelchair that is moved via the means of an electric motor and navigational



Self-propelled, non-foldable, wheelchair

www.canadiandesignresource.ca

Folding wheelchairs

Folding mechanism is available in both manual and powered wheelchair.

Manual wheelchairs are easy to fold where as, in case of powered wheelchair the battery needs to be removed requires assistance and training.



Power Wheelchair with controller
www.rehabwa.com.

Advantages of a Folding Wheelchair

- Folds for car transport
- Can be folded and stowed without removing any parts
- Its flexibility keeps all four wheels on the ground on rough surfaces
- Has swing-away leg rests, where rigid frames have fixed front ends
- Stores in out of the way places in small homes

Disadvantages of a Folding Wheelchair

- Has adjustable and removable parts that could break or be lost
 - Maybe too flimsy for certain sports
 - Seat angle is usually not adjustable
 - Harder to push than rigid models
- Less durable than rigid models



www.shermanoaksmedical.com

BASIC WHEELCHAIRS

Wheelchairs are durable medical equipment that include footrest and leg rest, sometimes offering an elevating leg rest capability, in either full-length or desk-length arms, and seat



Ultra light Wheelchair



Ergonomic Wheelchair



Transport Wheelchair



Active Wheelchair

BATHROOM WHEELCHAIRS

Bathroom wheelchairs (also known as shower wheelchairs) are designed to make hygiene maintenance easier for those who find it difficult or impossible to make it to the lavatory. These chairs typically feature an opening in the seat -- to allow users to toilet themselves while remaining on the chair -- and rust-resistant frames for use in the shower. Bear in mind that, when transferring your chair into the shower, you will most likely need a caregiver to assist.



Marine Wheelchair



Shower commode Wheelchair



Borris shower Wheelchair



Narrow shower and commode Wheelchair

RECLINING WHEELCHAIRS

Reclining Wheelchairs are specially designed to allow a person to comfortably recline at incremental angles safely and comfortably. Typically used for accommodation of severe hip extension contractures, orthostatic hypotension, and pressure re-distribution for prevention of skin breakdown.



High back Wheelchair



Foldable tilt adult Wheelchair



Foldable transport tilt Wheelchair



PEDIATRIC WHEELCHAIRS

Children's pediatric wheelchairs that cater to parents and caregiver who take care of younger people with certain conditions. Our wheelchairs provide assisting technology to all kinds of disorders; these rehabilitative benefits are further outlined in our pediatric stand up series of wheelchairs.



Pediatric stroller



Pediatric Wheelchair



Pediatric standup frame



Pediatric standing Wheelchair

TRAVEL WHEELCHAIRS

Transport foldable wheelchairs are a perfect solution for anyone looking for a lightweight portable frame, which features smaller rear wheel size, to allow more portability. Since smaller wheels are used with these chairs, they are designed to only be propelled by a caregiver or other individual, which explains why they are referred to as "companion chairs" in the industry. Chairs in this category weigh between 18-29 lbs., and most also feature swing-leg rests, and fixed armrests and side panels.



Light wheelchair



Ultra Light wheelchair



Detachable desk length arm wheelchair



Ultra light reclining Wheelchair

POWER AND STANDING WHEELCHAIRS

Standing wheelchairs from Karman Healthcare feature state of the art technology that can help change your life. Featuring an easy to access joy-stick controller that allows you to fully control the movement of the chair. It also features a stand up mode, which allows you to drive the chair while in a standing position. Standing chairs are typically used for environmental access and pressure relief. You can control the speed of the chair through the easy to access joy-stick controller, which is positioned perfectly within reach of any type of user. You can easily adjust the length of the arms in order to better suit your needs.



Power Wheelchair



Standing Wheelchair



Ultra light power Wheelchair



Portable folding mobility scooter

WHEELCHAIR ACCESSORIES

Seat cushion

Chair and cushion are a team, each influencing the other. The proper combination of chair and cushion will enable one to sit in a neutral and stable posture and to operate the chair safely. Cushions come in various depths and sizes which need to be accommodated by the size of the wheelchair frame.

The four basic types of cushions: foam, gel, air flotation, and urethane honeycomb, as well as designs and systems for more specialized needs.



Functions of seat cushion

The kind of cushion to choose depends on a variety of factors, including how much time is spent in the chair, how much one move around in the chair, and how stable the body posture is.

To prevent pressure sores: When we sit, only 1/3rd of the body's surface is supporting all of its weight, blood flow is restricted. In the presence of muscle atrophy which is experienced in spinal cord injuries - circulation is limited further by the loss of muscle which once served as a natural cushion. An additional risk of sitting is shear force, as we tend to slide forward in the cushion, causing stress across the surface of the skin. Resulting pressure sores (decubitus ulcers) can be very serious, leading to hospitalization, surgery, and though rare even death. The right cushion is a primary tool for maintaining the health of skin.

Provide postural stability: The right cushion helps to support the spine. For asymmetry in the body, one needs to be supported in a way that will not increase any spinal deformity. For manual chair users, greater stability in chair can help push the wheels with more confidence and strength. The wrong seating system leads to poor posture, which leads to physical problems, which leads to becoming more sedentary, which leads to a negative emotional and personal experience.

Foam cushions

Foam comes in a range of densities and with varying degrees of "memory," holding its shape as you sit, contributing to stability. The new foams can adapt to any shape, and still provide even support, spreading pressure across the sitting surface. Different foams are often used in combination, layered for their various properties of softness, even support, and memory. Foam is relatively inexpensive, and it is easy to cut.

Foam wears out faster than other materials and loses its shape. It needs to be replaced when its time is up as old foam that is compressed can allow pressure points to form that can lead to a sore. It can be used as a backup for air flotation cushion as gel & air flotation cushions can leak.



Gel cushions

Gel cushion designs attempt, in effect, to replace the consistency and support of atrophied muscle tissue. Highly engineered gel fluids are placed in pouches and usually attached to a foam base, so that the cushion conforms to the pressures placed on it. As a result, gel cushions provide excellent pressure distribution and are very comfortable. Many gel products also offer supplemental inserts to stabilize legs. When knees tend to fall together (adduction) or apart (abduction), such an accessory can help keep legs straight which also aids overall posture.

Another drawback to gel cushions is the possibility of them “bottoming-out” as the gel is pushed aside by body weight. It can be prevented by kneading the gel cushion once a day, keeping the fluids loose and spread evenly. The gel portion is divided into several sections so that all of the gel cannot push to the sides.

There is also chance of the gel leaking. While cushions arrive with patching kits, patches are ineffective when the breach is at a seam, which is often the case. A leak might be very minor, or it could be extremely messy.



Urethane honeycomb cushions

Thermoplastic urethane honeycomb cushions are the most recent development. Because there are many individual cells-like a beehive—these cushions are able to distribute weight evenly, but there is no risk of leaking gel or of an air bladder being punctured. The many open spaces in the beehive structure of the cushion allow air to travel more effectively. This design helps to protect against skin breakdown because your skin is kept cooler and moisture is prevented from collecting. Urethane honeycomb cushions are very light, absorb shock, and a low profile cushion can provide significant support. These cushions are washable hence can be used for people with incontinence.

Types of Urethane honeycomb cushions

- Multiple layers of varying stiffness to allow your sit bones to sink into the cushion while deeper layers provide overall support and weight distribution.
- Contoured to provide adduction and abduction, plus a rear dish for pelvic positioning.

Air or dry flotation cushions

It supports the body entirely on air. It is designed with a group of small, interconnected rubber balloons arranged in rows. Pressure is balanced by air shifting out to surrounding balloons, spreading pressure evenly against the skin. The whole system is closed so air flotation cushions can't bottom out the way gel cushions can.

If you have a pressure sore, you can tie off individual balloons to reduce contact under that area, allowing to spend more time sitting as the sore heals. It comes in many different sizes and shapes, is made of heavy duty rubber, and although different from the balloon design it is uniquely formed to minimize pressure at the bony protrusions on which we sit.

Air cushions can be less stable for those who move around a lot in their chair, but recent designs offer either low profile or quadrant options that minimize this problem. The balloons used in air cushions can be punctured, of course, and leaks do occur, although a fairly heavy duty rubber is used. But patching them is easier than with the gel design. The hard part is submerging the cushion under water to find the leak (look for escaping air bubbles).

The biggest drawback to air cushions is that they require more maintenance. It is necessary to check the pressure frequently, especially if you have pressure sores.



Alternating pressure

An air pump is used to create alternating pressure, for those with more severe disabilities who are unable to perform their own weight shifts to relieve pressure. Sitting for extensive periods of time without pressure relief causes the muscle and fatty tissues to separate, putting the delicate skin layer in closer contact with the bone, increasing pressure on the skin. Lack of air circulation increases the temperature between body & the cushion. Moisture collects & is trapped against the skin increasing risk of a sore.

Alternating pressure solution seating system that pumps air into and out of alternating portions of the cushion. The product is contoured for pelvic stability, with a pre-ischial cross-bar design that prevents forward slipping-and therefore shear-on the cushion. Special vent holes serve to allow the flow of air and moisture. In a five-minute cycle, compartments are inflated and deflated to shift support alternately between the ischial (sit) bones and the hips. Both areas get regular periods of complete pressure relief. It promotes blood flow and may also heal a pressure sore while you sit. This cushion system can be plugged into some power chair batteries or charged in a cigarette lighter in the car.

Alternating pressure products are of course heavier-given their use of batteries and air pumps-and, like air flotation cushions, prone to puncture.

Positioning systems

Advanced needs such as significant spinal curvatures or asymmetries in the body require more complex kinds of trunk support. Such as a support system which customizes seat and back cushions to ones exact shape. First, a special chair takes an imprint of the body's shape. A therapist views a computer image of the shape and can customize the contours of the cushion. From the imprint and the therapist's specifications, a foam cushion that gives an optimal support is manufactured. Since the cushion is formed to your shape, you will only be comfortable in it when you sit in the right relationship to the customized contours.

Spoke guard

Spoke guard or spoke protector are lightweight discs that cover the back wheels of wheelchairs to reduce injuries, by preventing fingers from accidentally going into the spokes of the wheelchairs. It also adds playfulness and personality to the wheelchair. The spoke guards are made of fabric or other lightweight sturdy material like acrylic, connected by band or snap-on.



Spoke guard

Wheelchair gloves

Wheelchair users hands are exposed to constant friction and heat generated by overuse, are numbed and desensitised in cold and wet weather. Active and athletic wheelchair owners are particularly vulnerable to overuse injuries. At least 18% of all wheelchair users experience blisters, abrasions, and lacerations and develop thick, rough calluses. Properly designed wheelchair gloves can provide:

- Protection against skin damage caused by friction.
- Protection against injury caused by vibrations and repeated impact
- Improved stopping and manoeuvrability
- Comfort in cold or wet weather



Harness / Securing straps

Supports and harnesses are available which provide support and encourage a child to sit in a firm, stable position and some also provided with alarm for fall monitor and safety. Waistcoat, bib and butterfly harnesses are more supportive and comfortable than shoulder and chest straps for children with poor trunk control.



Harness/ strap

Wheelchair bag

This detachable wheelchair bag can be used by children and adults to carry books and other items. It is provided with straps to hang to the assistant handles.



Wheelchair bag

Bottle holder

Provided for children who need to carry out activities from the wheelchair. Detachable bottle holder can hold bottles or cup to carry along and prevent spillage. They come in various colours and forms to match the wheelchair.



Bottle holder

Wheelchair canopy

It can be attached to wheelchairs or scooters to protect from the sun and rain. Ideal for outdoors for getting to and from work, daily errands, waiting at the bus stop. It can be of solid fabric or mesh material for ventilation. It can also come with additional drapes slip over and are easily removable.



Wheelchair canopy

Wheelchair lap tray

Provided for children who need to carry out activities from the wheelchair to increase independence. They are available in standard sizes or can be customized, including half and full size, flip to allow easy transfer and detachable. They come in variety of materials such as polycarbonate and with magnetic boards and protective edging to prevent spilling of objects. They can also be custom made from inexpensive materials like plywood and fixed by means of velcro to the frame.



Lap tray



Spoke reflectors



Wheelchair slippers

WHEELCHAIR TRANSFERS

Persons who use wheelchairs become much more independent if they can learn to transfer (get in and out of their wheelchairs) by themselves, or with limited help. For those who need some help, it is important to find ways to transfer that make it easiest both for the disabled person and the helper.

Too often, as disabled children get bigger and heavier, mothers and fathers hurt their own backs.

Different persons will discover their own 'best way' to transfer with or without help, depending on their own combination of strengths and weaknesses.

Transfer methods

It is often easier to transfer sideways out of a chair, and also back into it. To transfer sideways, however, a wheelchair without armrests, or with at least one removable armrest, is needed. Therefore, for many disabled children, make an effort to get or make wheelchairs without armrests or with removable armrests. Unfortunately, most wheelchairs in many countries have fixed, often very high, armrests. The following examples of transfers are both with and without armrests.

A good way to transfer the child who needs help:

Put the child's feet on the floor and lean her forward against your body. Have her hold on as best she can. Alternatively a sling can be used to lift and swing her onto the bed.

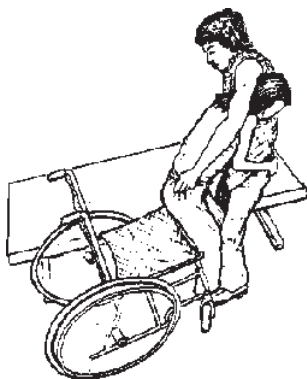

To lift the child, grip his pants or make a canvas or leather sling to help transfer

Transfer from cot or bed to wheelchair with armrests

1. Position your wheelchair so that you can swing body past armrests.
2. Place one hand on bed and one on the far armrest. Push yourself up while leaning forward with head down, weight over knees.

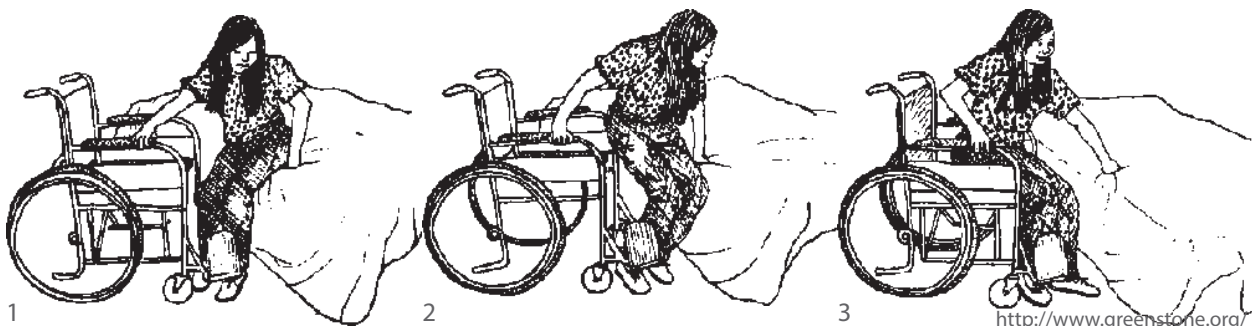

Ingress

- The wheelchair is pushed towards self in position.
- Once the wheelchair is in position to sit the hand brakes are applied to prevent the wheelchair from moving, make sure foot rest are up out of the way.
- Holding the wheelchair seat tube as pivot point with one hand and the bed with the other the buttocks are raised and transferred to the wheelchair.
- The wheelchair breaks are released and push rims are pushed to move.

Egress

- Pushing the wheelchair towards the bed or chair in position.
- Putting the hand brakes on to prevent the wheelchair from moving, foot rest are up out of the way.
- Holding on to the seat tube with one hand & resting the other hand on the bed or chair.
- Using the hand holding on the bed or chair as the pivot point the buttocks are lowered and rested on the bed or chair.
- The hand brakes are released and the wheelchair is kept away from the bed.

Transfer from bed to wheelchair and back



Transfer from wheelchair



Transfer 1:
Hips with arms extended



Transfer 2:
Head-hips with arm close



Transfer 3:
Trunk upright with arm extended

Transfer forward from wheelchair to cot or bed (works well for children)

1. Lift feet onto bed and wheel the chair forward against bed. Put on brakes. Then bend forward and lift butt forward on chair.
2. With one hand on the cushion and one on the bed, lift the body sideways onto the bed.
3. Repeated lifts and lifting of legs may be needed.

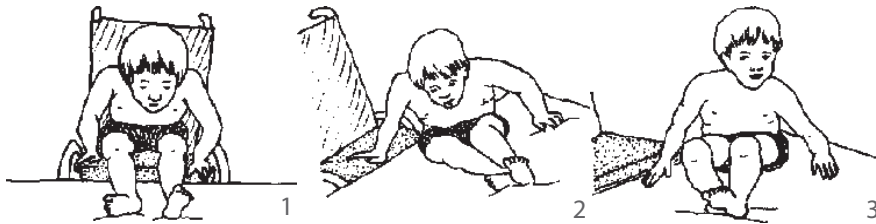

Transfer from floor to wheelchair - with help of a low seat

1. Sit with legs straight. Pull seat to your side opposite the wheelchair (a person's knee can also be used).
2. With hands on each chair, push up, with your head forward over knees.
3. Swing onto the seat.
4. Now, with your head forward over your knees, swing body onto the wheelchair.

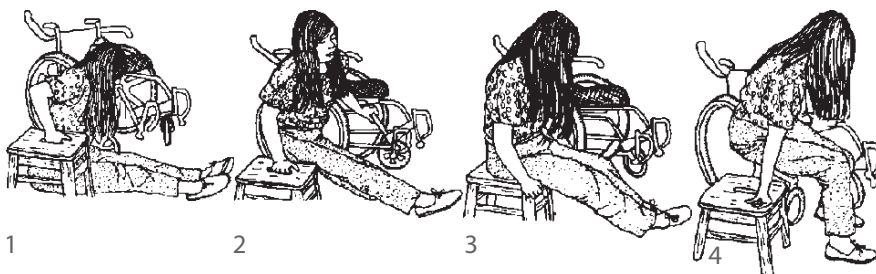

Transfer from wheelchair to floor and back again - without help of a stool

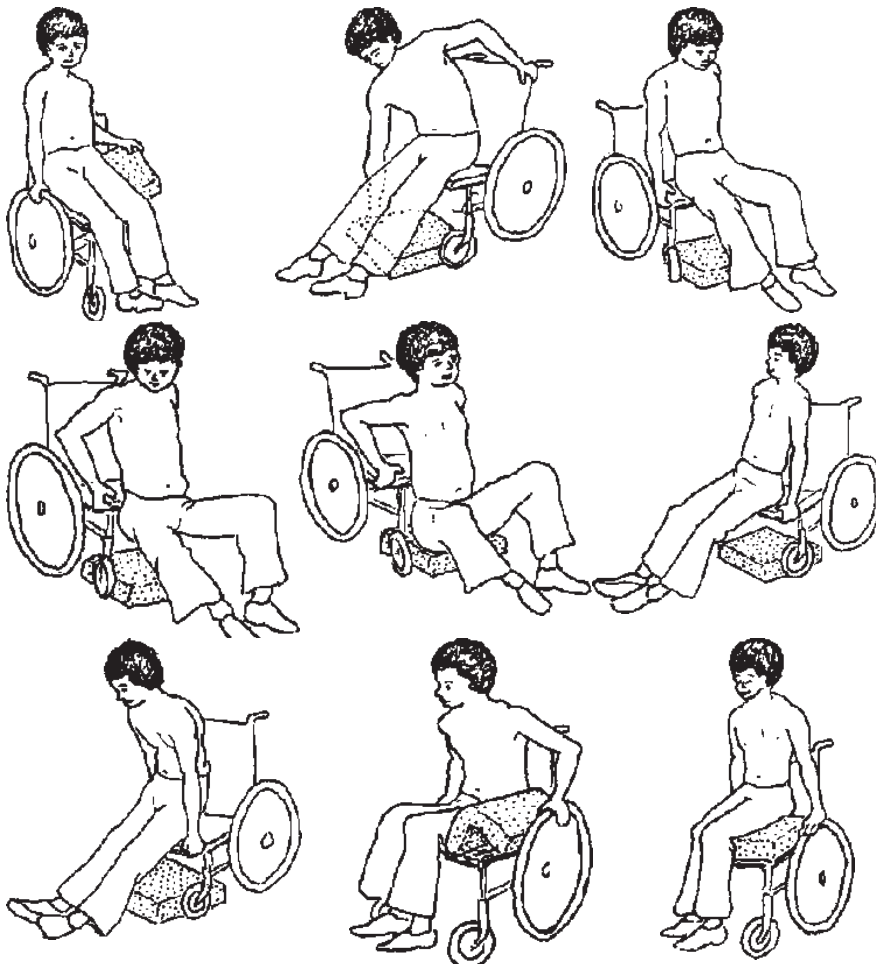

Transfer from wheelchair to toilet seat

Diagonal Approach (For narrow bathrooms, 3 to 4 feet in width size)

1. Position manual wheelchair diagonally about 6 inches away from toilet. Swing the footrest out of your way. Lock the brake.
2. Remove armrest. Place one hand on wheelchair seat and other on toilet seat. Redistribute weight on hands as you move across. Grab bar handle if necessary and sit on the edge of the toilet.
3. Move wheelchair out of the way and change position (some people fold chair or pivot it 90 degrees to the toilet)
4. Position yourself on toilet and release the brake.

For public bathrooms, paper is applied on the seat first, since the toilet seat is used as a brace to make the wheelchair toilet transfer.

Side Approach (For handicapped bathrooms about 5 feet in width size) 1. Position wheelchair to the side of the toilet. Remove the armrest and apply the brakes.

2. Use the same weight transfer technique on the hands to sit on toilet seat.
3. Grab bar handle to adjust your seated position on toilet.

To make your toilet transfer a lot easier, toilet transfer benches or handicap transfer boards are used that hooks onto your wheelchair and creates a bridge connecting the toilet seat to your wheelchair. There are other transfer boards that simply provide for a sliding board between two points. Another alternative to help wheelchair toilet transfer is to obtain some grab bars.

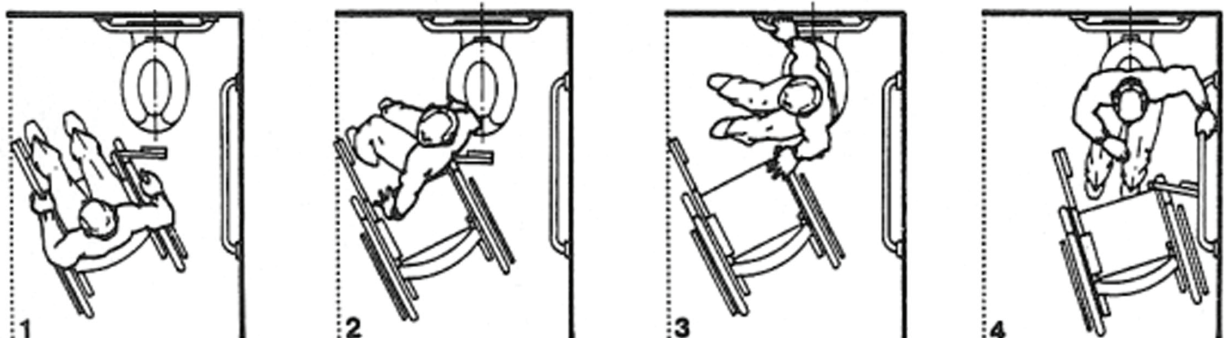

Diagonal transfer

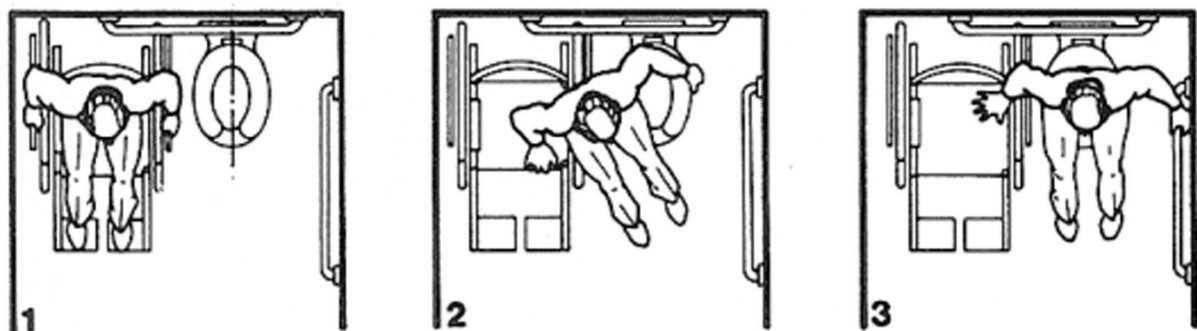

Side transfer

Transfer with sliding board without assistance - for getting into and out of bed, a car, etc.

1. Place board under hip by leaning to opposite side or by pulling up leg.
2. Lean forward, with your head and weight over knees.
3. Push yourself along the board.
4. When you are in the chair, remove the board and put it where you can easily get it.

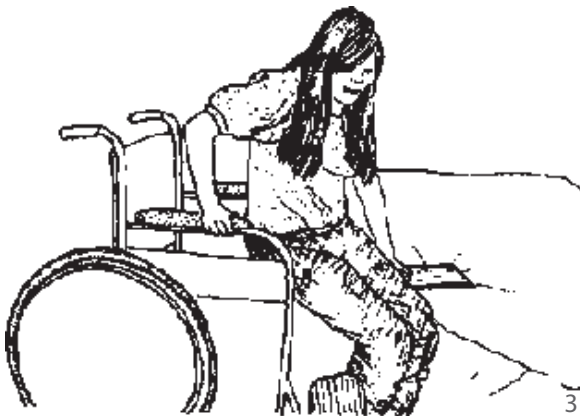
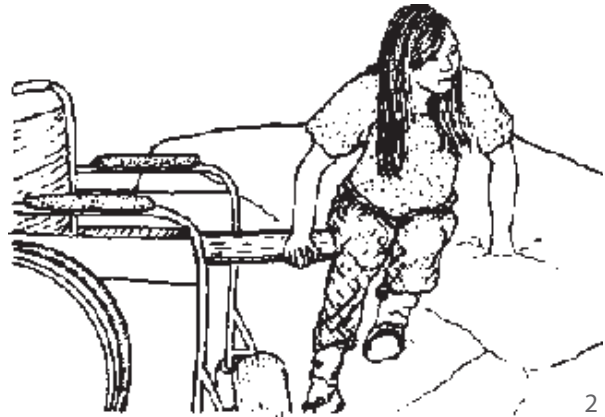

Toilet transfer board



www.handicappedequipment.org



child transferring from
a chair on a board— one
armrest removed

WHEELCHAIR DESIGN

Although basic ergonomic principles have permeated most modern seating in the mainstream of western society, they have yet to reach all corners of the wheelchair industry. Most wheelchairs available in low-income countries are still based on the basic cross-folding format, an outdated 1930's design that, because of its ease of manufacture, transport and storage has hung on perniciously, causing postural deformities and pressure ulcers. In richer countries, these wheelchairs are now acceptable only for short-term use, usually within hospitals and would not be considered for people who need postural support.

However, these wheelchairs are still being distributed widely in low-income countries under the philosophy that "something is better than nothing."

Unfortunately these products were not designed for everyday, outdoor use and do not survive long in the reality of low-income countries. The low production cost and convenience of folding for transportation would be positive factors if donor organizations provided supportive, pressure relieving cushions, adjustable backrests and increased local service capacity, which seldom happens.

As per the mainstream ergonomic practice the seating methodology should be based on achieving a neutral or as close to neutral posture as possible.

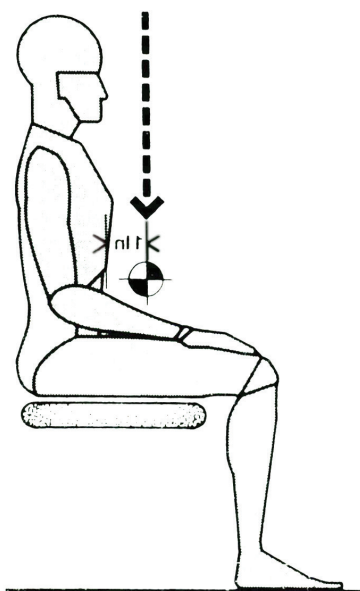

Centre of gravity of upright seated person

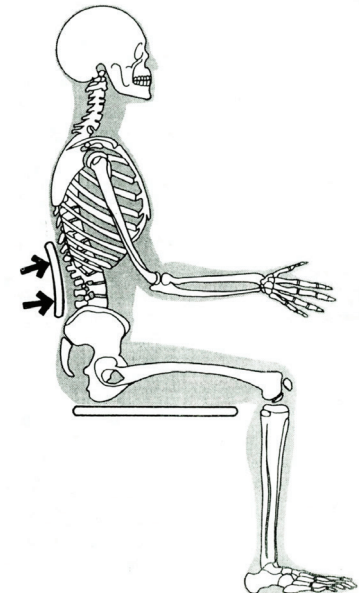

Primary function of the backrest is to provide support to the lumbar region. Provision should be made for the protrusion of the buttock area

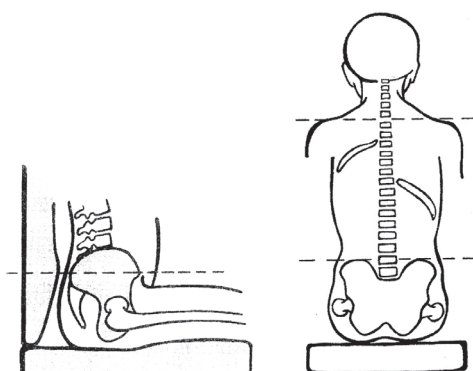

Neutral pelvic posture, side, back view

Seating

Pressure and discomfort

Pressure distribution has a clear relationship with discomfort during sitting. A higher pressure resulted in more discomfort. On earth, human bodies are under the influence of gravitational forces. Which means that the body is pulled downward due to its weight. Pressure on the bottom and under the feet carries most of this weight. To change these pressures it is possible to move the pelvis in three directions: yaw, roll and pitch. Movement is experienced when the discomfort rises above a certain threshold. The position of the pelvis influences pressure distribution under the buttock and a pressure also influences the position of the pelvis. (*Comfort and design- principles and good practice- Peter Vink*)

Just like child with cerebral palsy will have individual needs and might require great deal of support just to sit up, a person with spinal cord injury will need to sit on pressure- relieving cushion to stop hard surfaces from creating pressure ulcers. These different and complex requirements mean that ergonomic seated posture means different things to different people.

Pressure sores form when there is constant pressure on certain parts of the body. Long periods of unrelieved pressure cause or worsen pressure sores and slow healing once a sore has formed. Taking pressure off the sore is the first step toward healing.

Pressure sores usually form on parts of the body over bony prominences (such as hips and heels) that bear weight when you sit or lie down for a long time.

One can relieve or reduce pressure by:

- Using special surfaces to support your body.
- Putting your body in certain positions.
- Changing positions often.

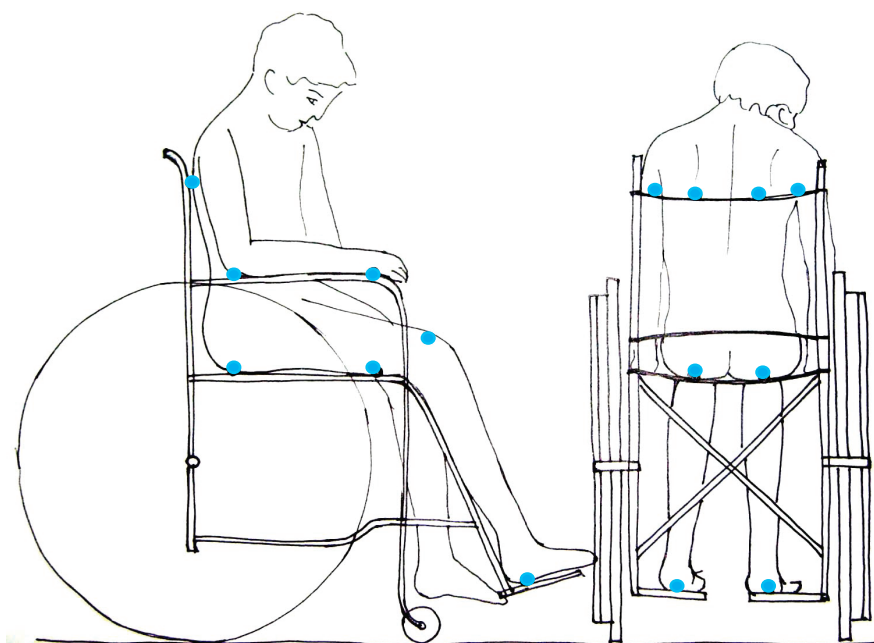

● Common pressure sensitive areas (side view)

● Common pressure sensitive areas (back view)

Common pressure spots experienced in case of folding wheelchair with fabric leather sling seating

Camber angle

Camber angle is the angle made by the wheels of a vehicle in relation to the road surface; the angle between the vertical axis of wheels and the vertical axis of the vehicle when viewed from the front or rear. If the top of the wheel is farther out than the bottom (that is, away from the axle), it is called positive camber; if the bottom of the wheel is farther out than the top, it is called negative camber.

Wheel camber is applied to the rear wheels of a wheelchair. It can be described as an angling that brings the top of the wheels closer to each other. Athletes who wish to improve wheelchair-handling characteristics and stability first introduced camber into wheelchairs. The amount of camber introduced into the wheels is measured in degrees. In general the camber angle for an daily use wheelchair is 2 to 4 degrees and for a racing wheelchair between 4 and 12 degrees.

Some wheelchairs have methods of adjusting the camber, while others do not. Camber adjustment is most often accomplished by inserting a different camber bar that alters the angle or by adjusting the axle plate for increased camber. Wheelchairs with fixed camber do not allow for altering the angle. In these cases the camber angle may be specified when the wheelchair is ordered (except in the case of low end wheelchairs).

As camber is increased, the width of the wheelchair across the bottom increases. This adds lateral stability to the system by increasing the wheelchairs footprint. If too much camber is added there may be a problem getting through doorways. The amount of camber required for daily use is not commonly the same as that which is required for sports.

Advantages ▲

- The wider footprint adds lateral stability to the wheelchair.
- Redirects forces to soften the ride.
- Places the push rims in a more ergonomic position for pushing. It is more natural to push down and outward.
- Protects the hands when pushing in tight areas since the bottom of the wheels will make contact first with walls and door frames.
- Less strain on shoulders since the plane of the wheel is closer to that of the shoulder.
- Makes turning quicker.
- Gives the wheelchair a sportier look.

Disadvantages ▼

- Wheelchair will be wider.
- May add cost to the chair.
- Excessive camber may cause the wheels to rub against the armrest side panels or against the user.
- Diminished traction and uneven tire wear on a conventional tire. Conventional tread placement is centred on the tire. A cambered tire rides on the inside edges of the tire. Some manufacturers make tires with offset treads to compensate for cambering.

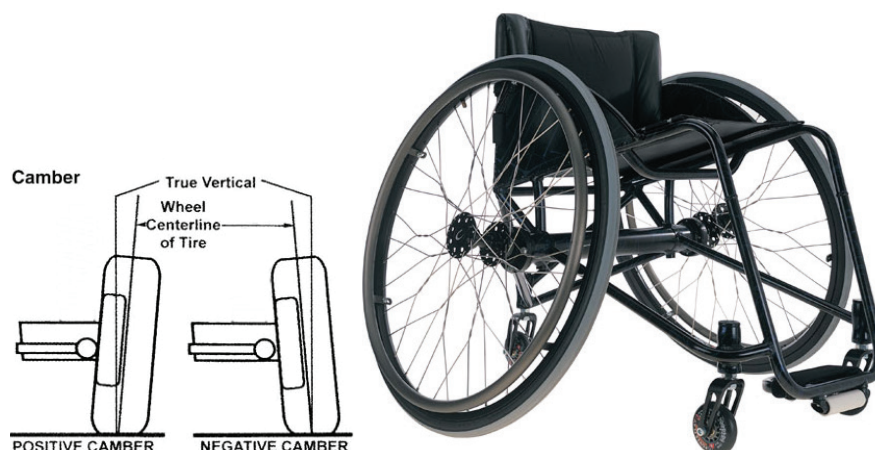

Seat position and biomechanics

Neutral or relaxed posture

It is when the joints are not bent and the spine is aligned and not twisted. Working in neutral postures is preferable to working to reduce strain and injury.

The effects of different chair positions on the strain and pressure distribution on the backrest, seat surface and foot rests can contribute to risk factors for occurrence of pressure sores - pressure, temperature and humidity. The pressure-distribution findings suggest that in the postures studied SCI (spinal cord injury) subjects have maximum pressures that are higher than able subjects in all postures, ranging from 6% to 46% depending on the posture. Maximum pressures can be reduced by postural changes: backrest recline to 120 degrees, -12%; and, full body tilt, -11%.

The effect of axle position on biomechanics.

The position of the seat relative to the rear wheels is generally adjusted to modify the rearward stability of the wheelchair. Recent studies have shown that seat position also has an effect on propulsion biomechanics and suggest that seat position can be optimized.

shows biomechanical changes associated with movement of the axle (F = resultant force). The large black arrows indicate the direction of movement of the axle relative to the shoulder and the information in the box indicates how this affects propulsion biomechanics. For example moving the axle further forward relative to the shoulder is associated with a decreased frequency of propulsion.

- The more forward position of the rear wheel improves push rim biomechanics, shoulder joint forces, push frequency and stroke angle.
- Manual wheelchairs with adjustable axle position appear to improve wheelchair propulsion and reduce the risk of upper extremity injury.

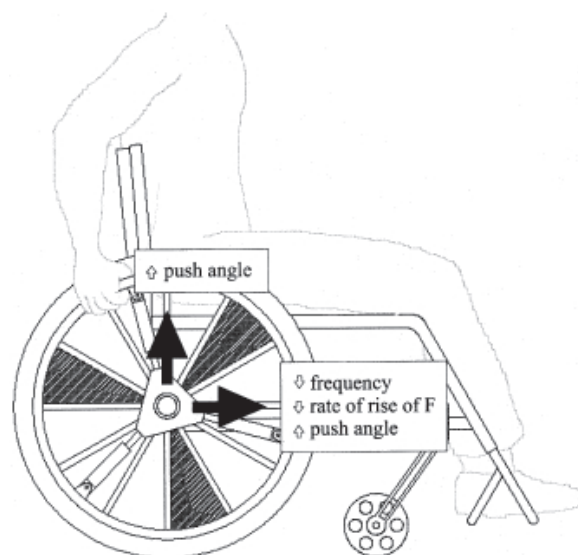
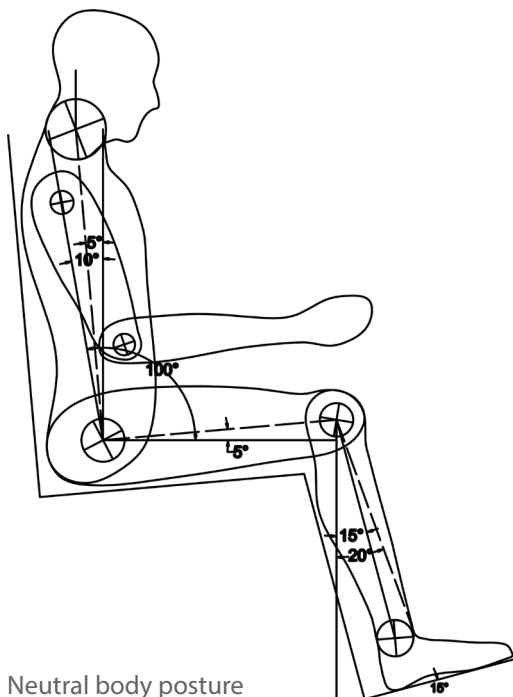

TRICYCLE

TRICYCLE

A tricycle, often abbreviated to trike, is a three-wheeled passenger vehicle, usually carrying a single rider.

It is one of the most simplest mode of transport system available for a common disabled user. This product is the most extensively used transport vehicle by the physically challenged users in India who have the need to travel a reasonable distance for their daily activities.

Human-powered trikes are powered by pedals or hand cranks. Motorized trikes use motorcycle or scooter engines, or electric motors. a conventional trike has poor dynamic lateral stability, and the rider must take care when cornering to avoid tipping the trike over.





HISTORY OF TRICYCLE

A three-wheeled wheelchair was built in 1655 or 1680 by a disabled German man, Stephan Farffler, who wanted to be able to maintain his mobility. Since he was a watchmaker, he was able to create a vehicle that was powered by hand cranks.

Two Frenchmen, named Blanchard and Maguier invented a tricycle in 1789, which prompted the Journal de Paris to coin the words 'bicycle' and 'tricycle' and publish them on July 27th to differentiate between the two types of machines.

British inventor Denis Johnson patented a tricycle in England in 1818, and a three-wheeled swiftwalker was introduced in 1819.

In 1876, James Starley developed the Coventry Lever Tricycle, which used two small wheels on the right side and a large drive wheel on the left side; power was supplied by hand levers. In 1877, Starley developed a new vehicle he called the Coventry Rotary, which was "one of the first rotary chain drive tricycles." Starley's inventions started a tricycling craze in Britain; by 1879, there were "twenty types of tricycles and multi-wheel cycles ... produced in Coventry, England, and by 1884, there were over 120 different models produced by 20 manufacturers." The first front steering tricycle was manufactured by The Leicester Safety Tricycle Company of Leicester, England in 1881 which was brought to the market in 1882 costing £18. They also developed a folding tricycle at the same time.

Tricycles were used by riders who did not feel comfortable on the high wheelers, such as women who wore long, flowing dresses. In the UK, upright tricycles are sometimes referred to as "barrows". Many trike enthusiasts ("trikies") in the UK belong to the Tricycle Association, formed in 1929. They participate in day rides, tours and time trials. Massed start racing of upright tricycles is limited to one or two criteriums such as in Bungay, Suffolk each year.

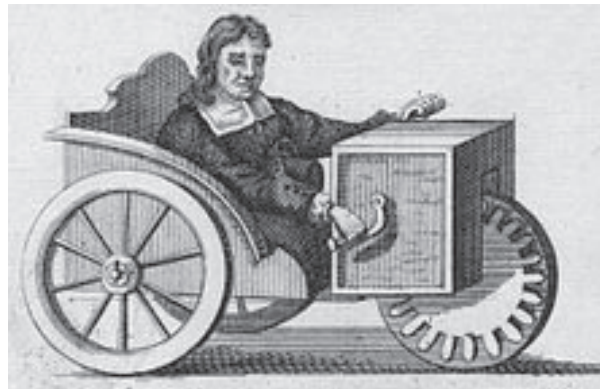

Stephan Farffler hand controlled three-wheeled wheelchair, 1655 or 1680



James Starley riding his quadricycle later made into a tricycle into which he built his invention the differential gear. The same principle used today in every motorcar

In the Philippines, a tricycle is a for hire, public utility vehicle consisting of a motorcycle and an attached passenger sidecar; it is not to be confused with the trisikad, an unmotorised, three-wheeled pedicabs also found in the country.

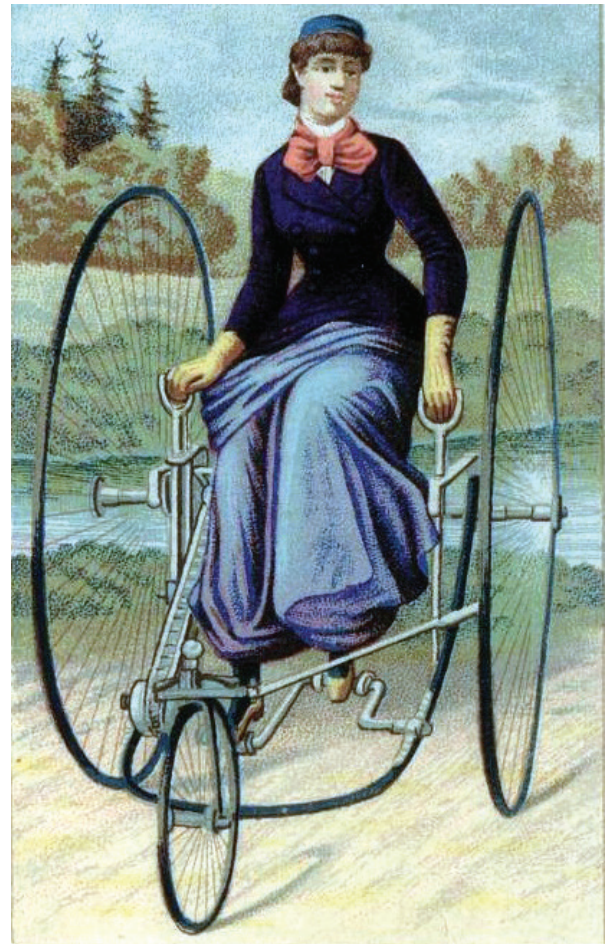

Lever drive tricycle

HAND PEDALED TRICYCLE

Is one of the most simplest form of transport system available for physically challenged. This product is the most extensively used transport vehicle by the physically challenged in India. The users of this vehicle are usually those who have the need to travel a reasonable distance for daily activities. The user often uses crutches for indoor mobility.

The trike is usually assembled at the supplier point, whereas the sub-components are manufactured at different locations across India. It is available in three different varieties:

- Left hand pedal
- Right hand pedal
- Both side pedal

The design

The design is a further extension of a bicycle with reinforcements and additional utility components. Basic components as tires, chain and sprocket, fork and peddles are retained. The rear part of the frame is drastically modified to accommodate the seat.

Seating and utility

Though it's meant for a single person (based on power requirement and capacity to pedal) the seat is wide enough to accommodate two persons comfortably. But this results in difficulty to pedal and manoeuvre the vehicle. Also it makes it impossible to use indoors. Ingress and egress space is abundant allowing easy entry and exit. The steering most often hits the head while ingress and egress.

Utility space is restricted to the seat. No dedicated space is present for storage of goods. Hence there is difficulty in operating the trike steering and pedal in case of any luggage being carried on the seat. Local modification has been done by the users themselves. These include hooking up cotton bags or attaching metal container boxes below the seat space. Overhead protection is not available with the trike. Usually a metal or plastic canopy is added by the user.

Anatomy Of Hand Pedaled Tricycle

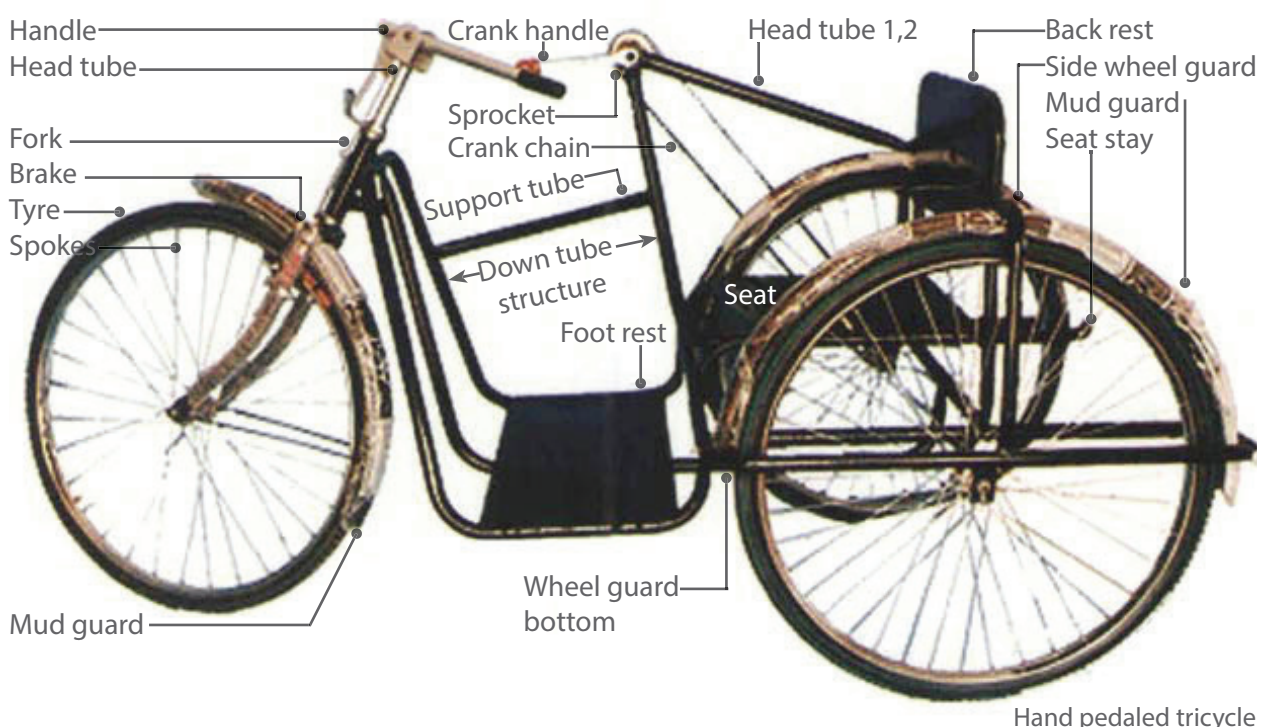

Manoeuvring

The vehicle is moved by pedaling and steering simultaneously. When riding the trike the users both hands are occupied. Accelerati on is done by pedaling while the brake is activated by pressing the steering handle downwards. Hence the steering hand is loaded with multiple functions of steering and braking, which at times demands simultaneous operation.

Manoeuvring on slopes is a taxing activity, specially when it comes to turning the vehicle. This is the cause of very low gear ratio of the pedals which demands for a lot of effort in getting the trike to gain momentum. The same issue is felt on down slopes when the braking and steering has to be done simultaneously. Brakes are provided on the front tyre only and are the same as a cycle, ie, cable operated rubber pads. The pedal drive is transmitted to one rear wheel only while the other is free. This causes trouble when one of the rear tyres (the idle one) is unable to move on the road.

Current Tricycle Design

Overall Dimensions:

Length: 1960 mm

Width: 890 mm

Height: 990 mm

Clearance from the ground: 120 mm

Seat length: 600 mm

Seat width: 430 mm

Framework: ERW MS Tubing

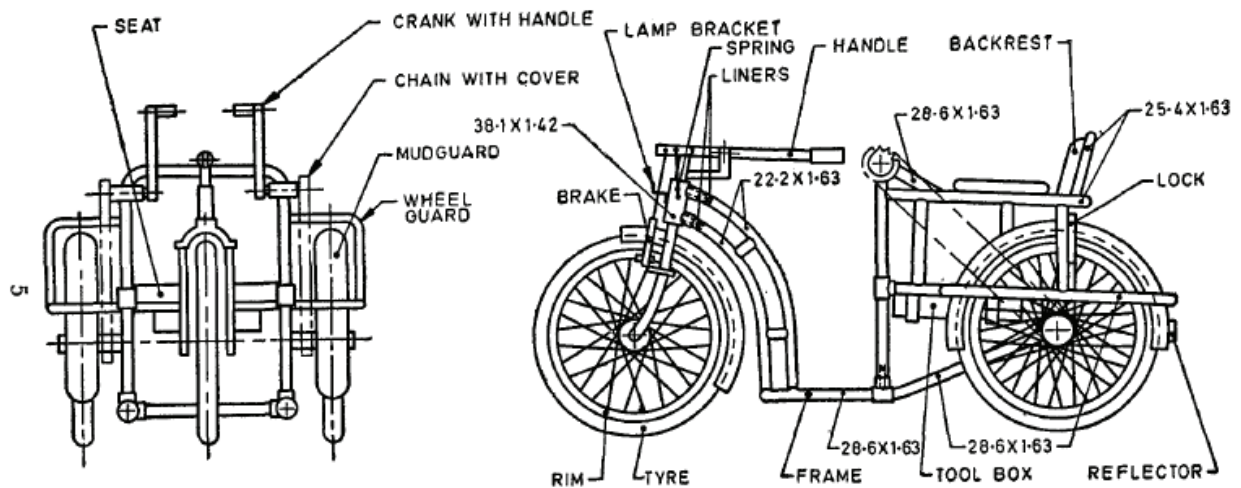

All dimensions in millimetres.

Current tricycle design

TYPES OF TRICYCLE

- Fork steered
- Lean steered
- Rowing cycle
- Off road
- Touring

Fork steered

Fork steer handcycles represent the majority of handcycles sold. They work well for both low and high-level spinal injuries, and most have adjustable footrests, seat angle, and come with a variety of gearing, wheel and tire configurations depending on intended use: racing, recreation, or touring. Manufacturers of this type of handcycle include Invacare (Top End), Intrepid Equipment, Varna, Schmicking and Sunrise Medical (Quickie).



Fork steered handcycle

Lean steered

Lean steer handcycles are another type of handcycle. In this type of handcycle the rider leans into the turn to steer. There is a longer learning curve with lean steer handcycles, and they are significantly less stable at high speed. The lean steer system feels similar to mono skiing: using your whole body to steer the handcycle. Lean steer handcycles can work well for lower-level injuries; although, some athletes with high-level disability use them as well. Manufacturers of this type of handcycle include Lighting Handcycles and Brike International Ltd. (Freedom Ryder).

Another type of lean steer hand trike has two steering rear wheels and one non-steerable, powered front wheel with handholds offset at 180°, similar to pedal cranks, that can be operated with only one hand, thus making it easy to ride on an up-hill, and it can be ridden in a tighter curve with the automatic rear wheels steering system.



Lean steered handcycle

Rowing cycle

A rowing cycle is propelled by a rowing motion of the body, with steering, braking, and gear shifting usually done via the handlebars. The feet are placed on symmetrical foot rests, as opposed to rotating pedals. Unlike many rowing boats, the rider faces forward. Rowing

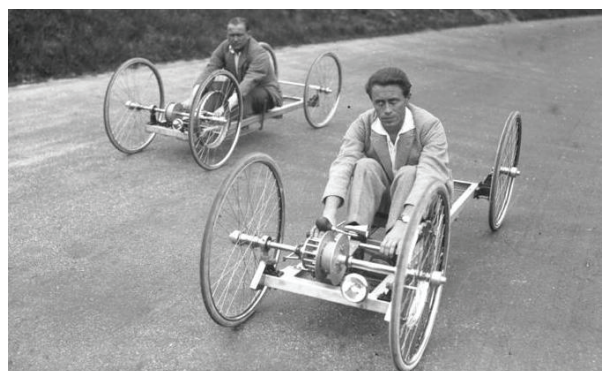

Rowing cycle

cycles exist in numerous designs, particularly with respect to frames and drive mechanisms. Commercial production numbers for rowing cycles are small compared to that of standard bicycles.

Off road

The off road handcycle is different from other handcycles in that there are two wheels in front and one behind, and it has a lower gear ratio range. This gives the cycle the ability to tackle steep slopes and permits handcycle mountain biking. The addition of a wider tire with suitable tread makes some mountain biking possible on standard road bikes.

Touring

Handcycles have also been used for touring, and to better accommodate this interest, some manufacturers incorporate mudguards and pannier cargo racks. As handcycles have evolved they have become progressively lighter, and they have better gearing for long climbs and long distance touring.



Off road handcycle



Touring handcycle

USER SURVEY AND ANALYSIS

PARAPLEGIC REHABILITATION CENTRE, PUNE

The Paraplegic Rehabilitation Centre (PRC) in Kirkee, Pune is a Charitable Public Trust which is engaged in physical, psychological, financial rehabilitation of Paraplegic and Quadriplegic ex-servicemen of the Indian Armed Forces, who are confined to wheelchairs as a result of injury to their spinal cord.

The thought of building a Paraplegic Home (now named Paraplegic Rehabilitation Centre) was conceived after the 1971 Indo-Pak War when there were 60 Spinal Cord Injury casualties. It was based on already existing such facilities in USA (Veterans Home), UK (Spinal Cord Injury Centre Stokes Mandeville Ayelsbury) and other European countries.

The foundation stone was laid by General (Late) GG Bewoor, the then Chief of Army Staff on 23 June 1973 and the Centre was inaugurated by (Late) Shri Fakhruddin Ali Ahmed, the then President of India on 20 Sep 1974.

Paraplegic Rehabilitation Centre is the largest center of its kind in India having 83 single beds and 26 married quarters making a total of 109 bedded hence making it one of the largest in South east Asia.



Activities at Paraplegic Rehabilitation Centre, Pune



PARAPLEGIC REHABILITATION CENTRE, PUNE USER SURVEY

Name BSN Rao
Age 46
Marital status Married
Diagnosis Quadriplegia
Mode of injury Fall
Occupation NA
Vehicle using/ used Wheelchair



Name Makhan Lal
Age 55
Marital status Single
Diagnosis Paraplegia
Mode of injury Fall
Occupation Training workshop
Vehicle using/ used Tricycle, Wheelchair, modified Kinetic



Name Narbahadur Pun
Age 59
Marital status Married
Diagnosis Paraplegeia
Mode of injury Accident
Occupation Ex- training workshop
Vehicle using/ used Wheelchair, Tricycle



Name Rindol
Age 46
Marital status Married
Diagnosis Quadriplegeia
Mode of injury Accident
Occupation NA
Vehicle using/ used Motorised Wheelchair,
Manual Wheelchair



Name Govind Babar
Age 43
Marital status Single
Diagnosis Paraplegia
Mode of injury Accident
Occupation Training workshop
Vehicle using/ used Tricycle,
manual Wheelchair



Name Pandurang Yadav
Age 49
Marital status Married
Diagnosis Paraplegia
Mode of injury Accident
Occupation PRC's telephone booth
Vehicle using/ used Tricycle, Wheelchair,
modified Kinetic



OBSERVATIONS

- Minimum daily travel distance more than 3 km & time for travel is approx. 2 hours
- Vehicles are provided by PRC on concessional rate
- Use tricycle outdoor & wheelchair indoor
- Unable to put hood or cover on tricycle because of weight issue & no such need to add on wheelchair
- Difficult to use wheelchair outdoor as no drive mechanism
- Need help while travelling on steep roads (i.e. flyover)
- Faced issues with electric powered vehicle being bulky & heavy weight as compared to manual wheelchair (in case of electric wheelchair)
- Feel pain in shoulders & palm while travelling on long distance
- Unable to travel on tricycle because its difficult to push such heavy vehicle & age factor
- Tricycle is non folding vehicle, face problems while parking being larger in size, and happy being having manual fold-able wheelchairs.

Wish-list

- Feel need of external power source like battery powered
- Feel the change in look of the vehicle
- Feel weight should be reduced to make ride easy.

FELLOWSHIP FOR PHYSICALLY HANDICAPPED (FPH), MUMBAI

In 1956, Fathema Ismail started a small workshop from thatched barracks with just seven trainees and only three activities. Today, the number of trainees has increased to 175, receiving vocational training in 10 departments/trades. Vocational training is imparted to the beneficiaries FREE OF COST, including facilities like hostel, lunch, pick up and drop, medical and educational support. FPH serves those adults who have orthopedic and mild mental disabilities and are in the age group of 18 to 40 years. There is no pre-requisite qualification required and FPH keeps its doors open for any disabled persons who wish to avail of its services, whether illiterate or educated to any level irrespective of their caste, creed, sex or religion. Funds to run the institution are generated from donations, sponsors, sale of FPH products, grants from Social Welfare Department of the Govt. of Maharashtra and other resources.



Name Vinayak Mohite
Age 43
Marital status Married
Diagnosis Paraplegia
Mode of injury Accident
Occupation Training workshop
Vehicle using/ used Wheelchair, Tricycle
Stay Sion East, Mumbai



Name Tushar
Age 24
Marital status Single
Diagnosis Poliomyelitis
Mode of injury NA
Occupation Training workshop
Vehicle using/ used Wheelchair, Tricycle
Stay FPH hostel



Name Ashish Singh
 Age 34
 Marital status Married
 Diagnosis Amputee
 Mode of injury Accident
 Occupation Training workshop
 Vehicle using/ used Wheelchair, Tricycle
 Stay Vakola, Santacruz East, Mumbai



Name Pascal
 Age 24
 Marital status Single
 Diagnosis Poliomyelitis
 Mode of injury Fall
 Occupation Training workshop
 Vehicle using/ used Tricycle, Wheelchair,
 Stay FPH hostel

Name Geeta Devi
 Age 26
 Marital status Single
 Diagnosis Poliomyelitis
 Mode of injury NA
 Occupation Staff at FPH
 Vehicle using/ used Wheelchair, Tricycle
 Stay FPH hostel

OBSERVATIONS

- Minimum daily travel distance more than 10 km & time for travel is approx 60 min
- Works in FPH workshop
- Approx monthly 1500 INR
- Sunday holiday & works 9am to 5pm in FPH
- Vehicles are provided by FPH
- Use tricycle outdoor & wheelchair indoor
- Unable to put hood or cover on vehicle because of weight issue.
- No use of additional attachment for toilet
- Face pain in shoulder while travelling on long distance
- Need help while travelling on steep roads (i.e. flyover)
- Always feel fear that break provided on front wheel will fail and an accident may occur
- They are tagged as beggar'
- Face problems while accessing objects kept on higher level
- Non folding vehicle, face problems while parking being larger in size.
- Lack of grip, support & harnesses while paddling.

Wish-list

- Feel need of external power source like battery powered
- Feel the change in look of the vehicle
- Feel weight should be reduced to make ride easy.
- Feel that width can be made adjustable to make easy in accessing in small gullies and lanes
- Feel need of brakes on rear wheels for better control



Tricycle with protective canopy



Storage box behind the tricycle seat



Chain guard



Tricycle assembly at the workshop



Tricycles stacked vertically to save space



Reflectors on the spokes



Brakes & bicycle brakes on the front handle



MANUFACTURING

OTHER TYPES OF TRICYCLES

USER SURVEY, Morwadi

Name	Barkat Ali
Age	26
Marital status	Unmarried
Diagnosis	Poliomyelitis
Mode of injury	NA
Occupation	Shopkeeper
Vehicle using/ used	Tricycle



Observations

- Minimum daily travel distance more than 3 km & time for travel is approx 20 mins
- Runs own shop
- Approx monthly 1500 INR
- Vehicles are provided by local corporation
- Use tricycle outdoor & no vehicle indoor
- Unable to put hood or cover on vehicle because of weight issue.
- No use of additional attachment for toilet
- Face pain in shoulder while travelling on long distance & steep roads
- Need help while travelling on steep roads (i.e. flyover)
- Always feel fear that break provided on front wheel will fail and an accident may occur
- Non folding vehicle, face problems while parking being larger in size.
- Feel need of support and harnesses because of lack of availability of grip while paddling.
- People refuse to repair the punctured tyre and hence he himself repairs the puncture.

Wish-list

- Feel need of external power source like battery powered
- Feel weight should be reduced to make ride easy.
- Feel that width can be made adjustable to make easy in accessing in small gullies and lanes



Calliper brakes only on front wheel



All surfaces including the seat back rest are in metal which get hot during summers and cold during winters



Touch points provided with hard grip



Footrest in metal gets hot as the user wears no shoes



Metal parts rust due to exposure to environmental conditions



Terrain in which the wheelchair is used

TRICYCLE TRANSFER

Ingress

- Ingress is possible only from the left hand side of the tricycle as the push handle blocks the way on the right side
- The front handle bar is pushed away to get access to the tricycle
- User moves sideways towards the tricycle
- Rests his right arm on the foot rest for support
- Gradually moves his body upwards by taking the support of the seat by resting his elbows
- Moves his legs forward towards the footrest
- Putting his entire weight on his elbows that are supported on the seat he pushes his body in seating position
- Rotates his body to face front of the tricycle
- Pulling the handle bar towards himself he releases the brakes and holds the push pedal to move the tricycle forward

Observations

- Since the brakes are caliper brakes the tricycle cannot be put in a steady position to prevent movement while ingress and egress
- Ingress and egress is possible only from the left side
- The front brake handle keeps hitting the head while ingress and egress
- Upper body strength is required for all the operations



Egress

- Getting out of the tricycle is also possible only from the left hand side.
- Holding the front handle bar with his left hand and resting his right elbow on the seat the body is pushed towards left while facing right
- The legs are momentarily in air unsupported
- While taking the support of the front main tube of the tricycle and the seat the body is pushed further backwards until the legs reach the ground
- Once the legs reach the ground the entire body is pushed backwards to rest on the ground on the knees

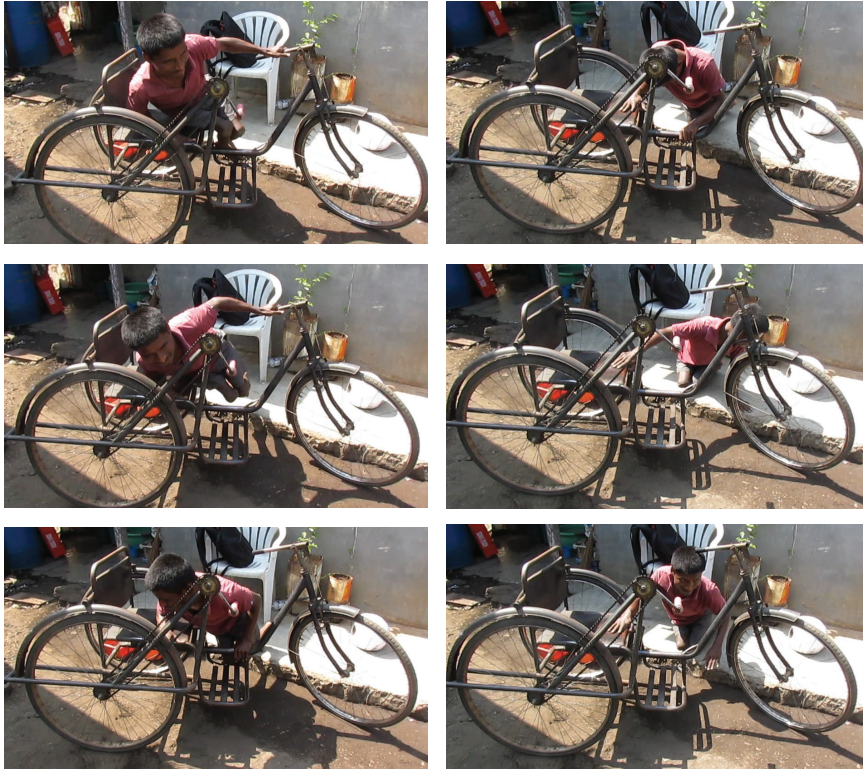

Touch points while ingress and egress

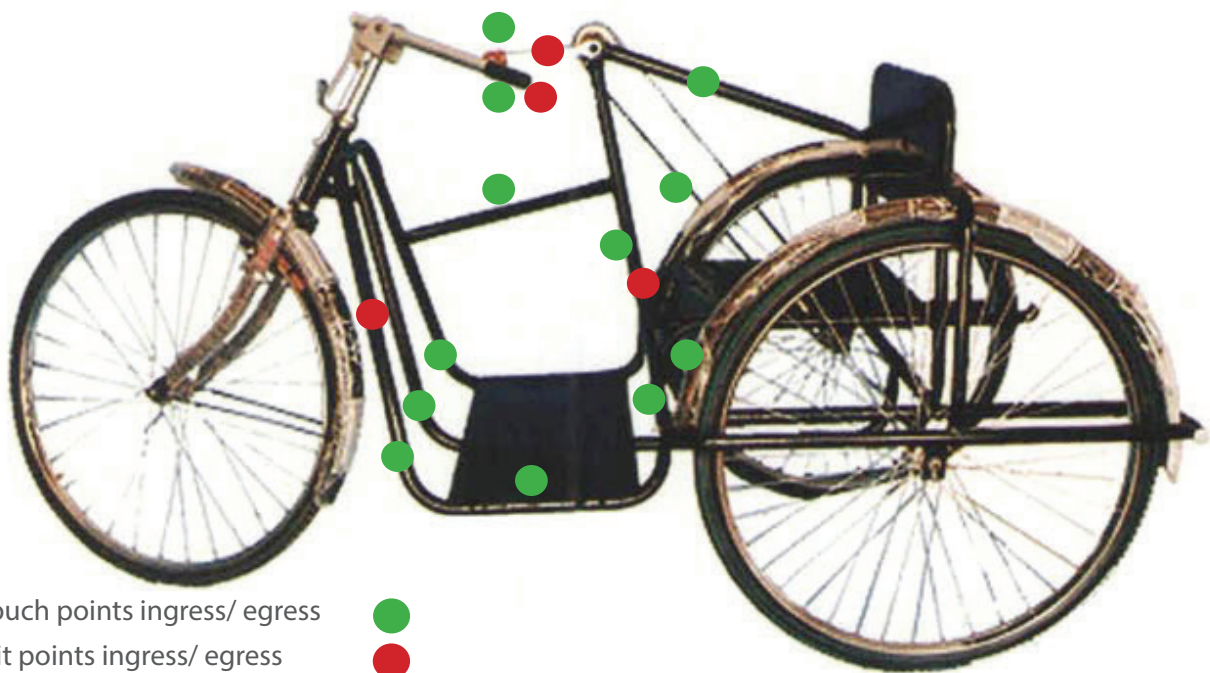

DAILY ACTIVITIES

Daily activities of a mobility impaired person has been divided in 2 groups

Activities of Daily Living (ADL)

- Maneuvering inside and throughout the house
- Getting in or out of the bed or a chair
- Bathing
- Dressing
- Eating
- Toileting

Instrumental Activities of Daily Living

- Going outside the home
- Keeping tracks of money and bills
- Preparing meals
- Doing light house work or office work
- Taking medicines at right time
- Using telephone

Problems

- Use of different cycles for indoor & outdoor.
- Tricycle is heavy weight & large in size.
- No weather protection.
- Pain in shoulders while travelling for long distance.
- Face difficulty while travelling on steep roads. Need support or help.
- Tagged as baggers.
- Feel fear of accidents as brakes are only provided on front wheel.
- Lack of supports ,harnesses & grip.

Wish

- Battery powered
- Change in the look
- Reduced weight and size
- Brakes for rear wheels should be provided
- Adjustable in width

REDESIGN BRIEF

REDESIGN BRIEF

Initial design brief

The objective of a project is to design a mode of a transportation for mobility impaired person. The conveyance which reduce efforts and support them to carry out day to day commute.

Study the modest solutions that are used at present and understanding their operation. Also studying lifestyle of a mobility impaired person and providing affordable solution.

After carrying out intense research into the area of transportation for mobility impaired and analysis of the data available following are the observations

- There have been great deal of research and innovation in the design of wheelchair and to make them better
- On the other hand pedaled tricycle design still remains the same over the years
- This humble mode of transport for the lower income group has not seen any modifications or redesign as they are mostly donated and have to be cost effective
- Although in western countries there have been great deal of variations in the tricycle design and are used for various purposes other than transportation
- Outdoor mobility device is not designed to be used indoors and vice versa

Hence after careful evaluation the redesign brief was formulated to design mode of transportation for outdoor use. Three wheeled human powered vehicle that also offers convertibility, affordability, comfort and ease the efforts required to operate the HPV.

PROJECT SCOPE

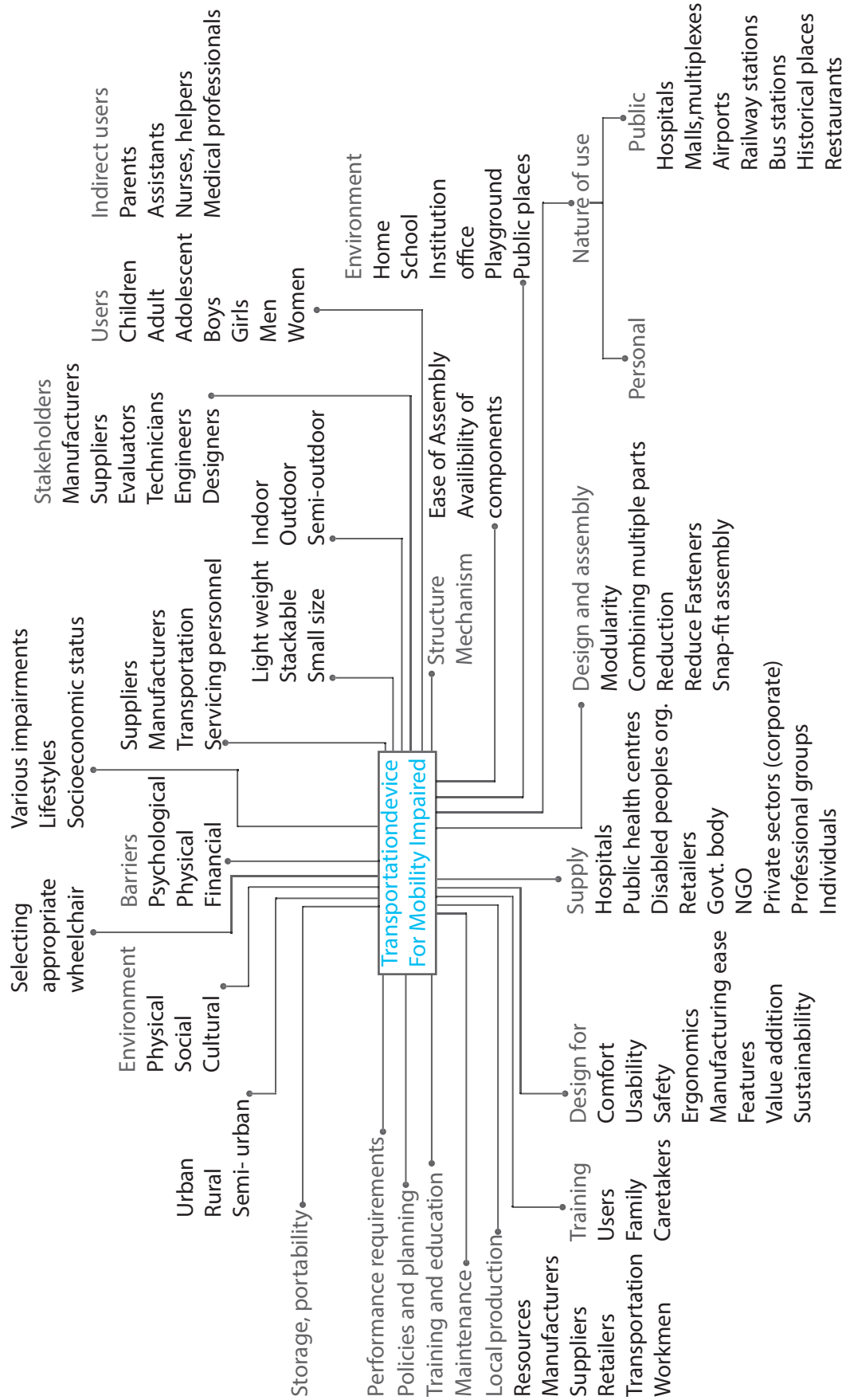

MATERIALS

FRAME

Aluminium
Steel alloy
Carbon fibre
Aircraft Aluminium
Chrome-moly steel
Titanium
Other composite materials

SPOKE GUARD

Acrylic
Polycarbonate
Fabric
ABS
Alloy

ALT. FOR SPOKES

Bicycle spokes
Fibre spokes/ Mag wheels
Carbon fibre spokes
Coloured spokes
Kevlar strings
Spoke less, Mag wheels

FINISHES

Paint- Matte
Paint- Glossy
Textured
Cushioned

FOOT REST

Aluminium Composite
Fibre moulded
Transparent lexan or carbon

CUSHIONS

Leather
Vinyl
Gel filled
Sling seat
Air filled
Electric ripple
Inflatable- air, water
Foam

PUSH RIM

Aluminium
Chrome plated
Plastic coated
Fibre
Plain
Serrated
Texture painted
Titanium
Vulcan wheel

HUB

Aluminium
Steel
Alloy
Carbon fibre

TIRES

Pneumatic
Solid
Gel filled
Urethane
Urethane - High Profile
Pneumatic - Flat-Free

BREAKS

Front independent drum
Brakes and rear cantilever
Brake C/W parking brake

ARMREST

Steel
Lexan
Carbon fibre
Composite

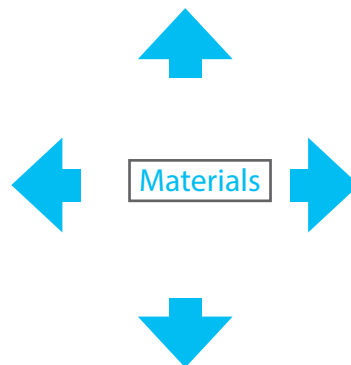

USER PERCEPTION

The people met for the user survey had the most positive attitude and never say die spirit. Following are their hopes, fears, emotions and aspirations. The attributes are drawn from these to represent the expectations of the users form the product. The attributes form an inspiration for the form, function and feel to the product.

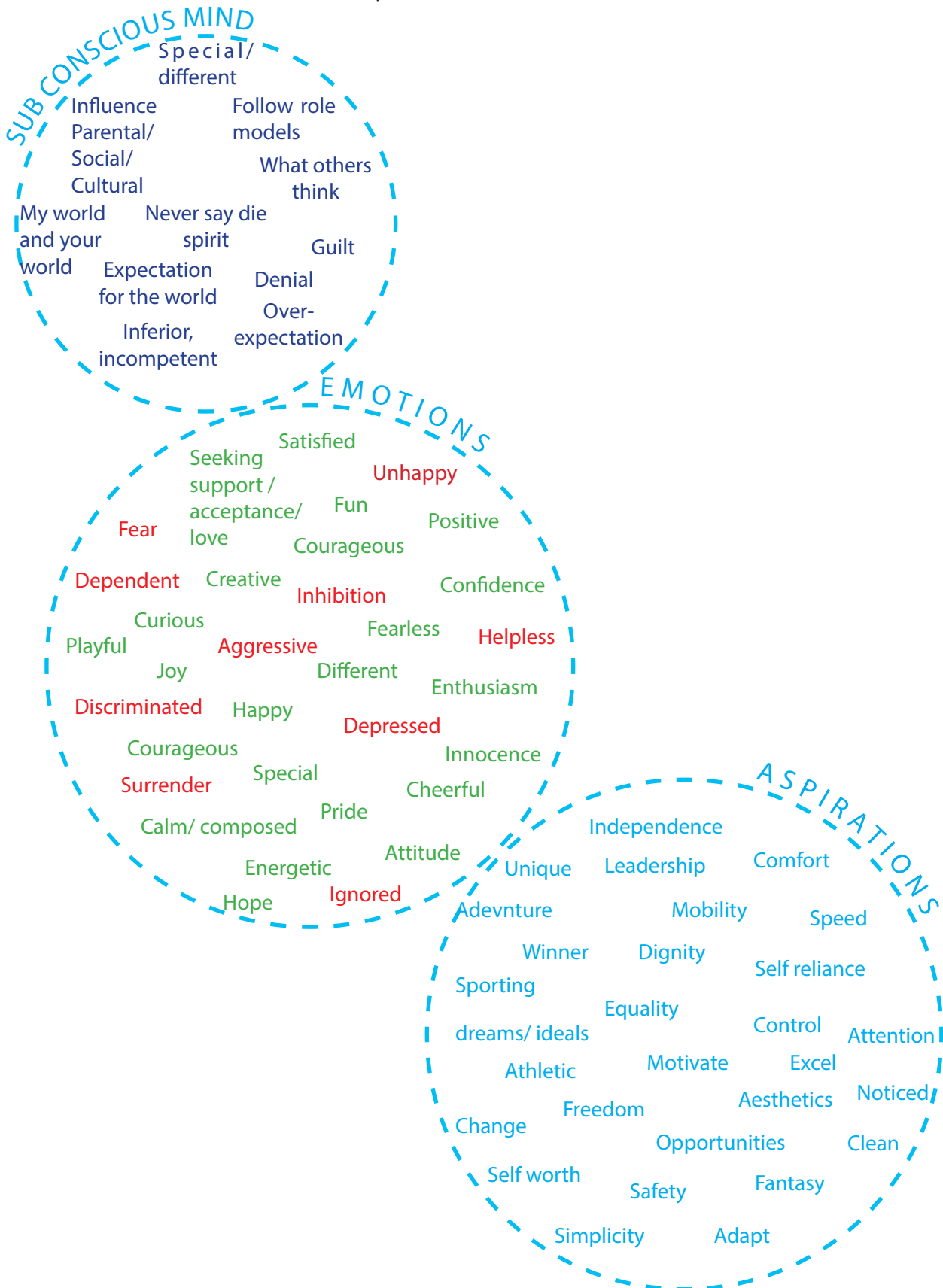



STURDY



MINIMALISTIC



INDEPENDENT



LIGHT



ASPIRATION

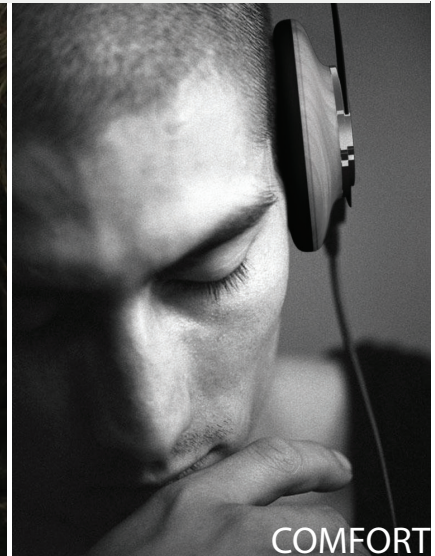

COMFORT



BALANCED

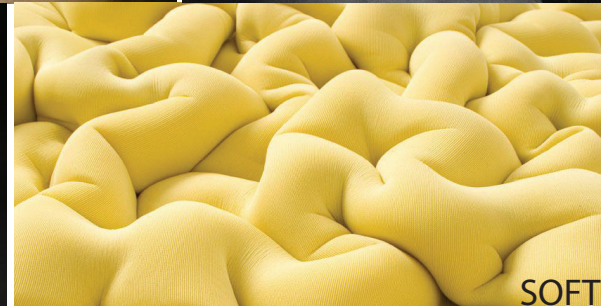

SOFT

ANTHROPOMETRIC DIMENSIONS

Mid position length(Forward arm reach)	5th Percentile
Male	749
Female	704
Combined	729

Erect Sitting	75th Percentile
Top of the head sitting in erect stretched posture	
Male	867
Female	802
Combined	857

Upper Lumbar	5th Percentile
Upper most point of the first lumbar vertebra	
Male	254
Female	226
Combined	189

Elbow rest	75th percentile
Male	236
Female	218
Combined	234

Popliteal	5th Percentile
Popliteal angle at the underside of the thigh immediately behind the knee where the tendon of the biceps femoris muscle inserts into the lower leg	
Male	380
Female	365
Combined	374

Buttock to popliteal length normal sitting	5th Percentile
Horizontal distance from the most posterior point on the uncompressed buttocks to the most anterior point on the knee (knee at right angle)	
Male	399
Female	384
Combined	394

Hip breadth	95th Percentile
Maximum horizontal distance across the hips	
Male	405
Female	429
Combined	406

Elbow to elbow (relaxed)	50th- 95th Percentile range
Horizontal distance across the lateral surfaces of the elbow when in maximum relaxed position, spreading sideways	
Male	644
Female	572
Combined	632

Chest, below bust	50th- 95th Percentile range
Horizontal distance from the back to the front of the chest below the nipple level	
Male	247
Female	235
Combined	247

Abdomen	50th- 95th Percentile range
At the level of the maximum extended point of the abdomen	
Male	1059
Female	880
Combined	1059

Waist	50th- 95th Percentile range
At the level of the upper margin of the lateral iliac crest (where the belt is worn)	
Male	1020
Female	946
Combined	1019

Hand breadth with thumb	95th Percentile
Maximum breadth across the palm with the thumb at right angle to the long axis of the hand	
Male	111
Female	95
Combined	109

Grip inside diameter (maximum)	95th percentile
Maximum inside grip diameter, measured by sliding the hand down a graduated cone until the tips of the thumb and the middle finger remain touched to each other	
Male	56
Female	52
Combined	56

Foot length	95th Percentile
Distance parallel to the long axis of the foot, from the back of the heel to the tip of the longest toe	
Male	274
Female	249
Combined	271

Foot breadth	95th Percentile
Maximum horizontal distance, wherever found across the foot, perpendicular to its long axis	
Male	106
Female	96
Combined	104

Chest breadth (on bust)	75th Percentile
Maximum horizontal distance, across the chest at nipple level	
Male	319
Female	293
Combined	314

CONCEPT SKETCHES

CONCEPT 1

With gears

Features

- Small in size
- Hand propelled
- Multiple gear arrangement
- Gears provided on both paddle and wheel sprockets

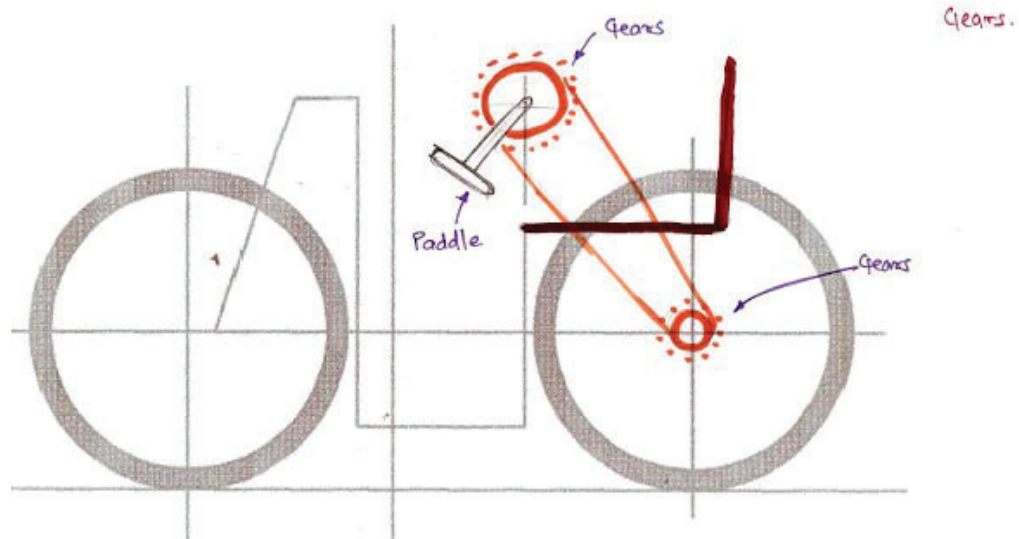

CONCEPT 2

Spring winding mechanism

Features

- Partially coil spring powered
- Working as a winding spring toy car
- Spring stores potential energy by means of external power
- Stored energy can be utilized as per requirement i.e. steep roads or flyovers
- Rewinding can be done during regular paddling or on slopes

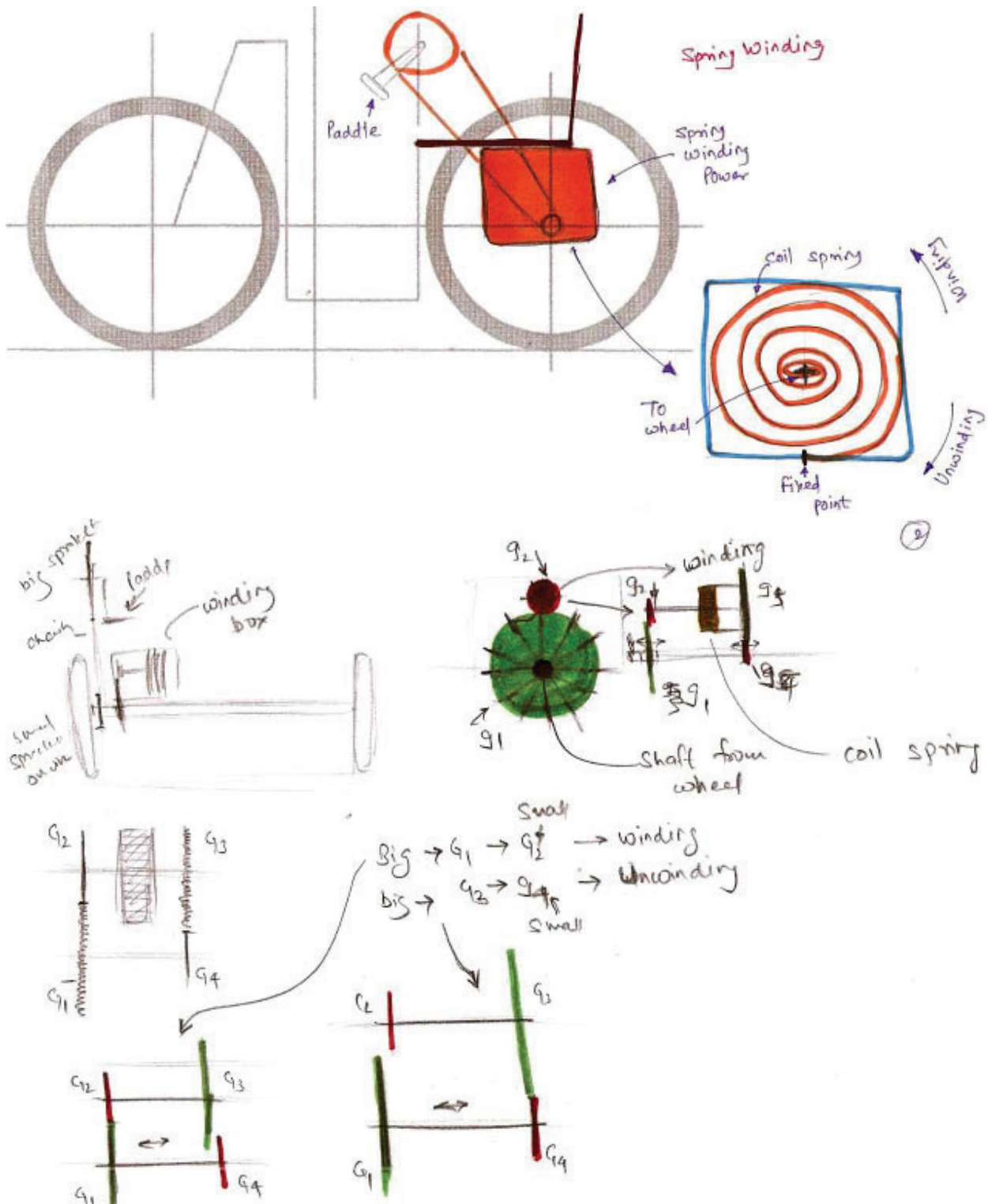

Spring winding mechanism

They are used all over the place - in wind up toys, cam and crank toys, or even in mechanical clocks. They are used to store kinetic energy just like the batteries are used to store electrical power. The wind up motors exist - even much earlier than batteries.

How does it work

- Number (1) in the graphic above is the key that winds up the motor. It's not absolute must - some toys use simple pullback motors. But most good wind-up toys have winding keys.
- The key is used to wind the spring (2). This spring is the battery of every wind-up toy. It's natural position is unwind, like shown in the graphic. With the key you can tighten it thus transferring the kinetic power from your fingers to the spring. This spring then has a stopper in the other end (3) which prevents the free rotation and makes sure the energy is stored in the spring. If you released this spring immediately it would quickly return to its natural position.
- Because of stop mechanisms in most wind-ups the spring doesn't get released until you push some button or pull a trigger or so. Once this is done, the spring starts unwinding. But it's attached to a main gear (4) - a rack-wheel that rotates when the spring unwinds.
- The big rack-wheel is connected to another one (5) (in this case much smaller) and transfers its rotation to it. As the radius of the main gear is much bigger than the small gear (5) just one its rotation forces (5) to rotate about 10 times.
- The small gear (5) is directly connected to the spindle that holds the car wheels. So the rotation causes the entire car to move.
- Because of the friction between the wheels and the ground, and the car mass, the spring can't unwind super-fast, as it would unwind if there was no big to small gear transmission. So the spring unwinds slow letting the toy work for a while. And for the 10 or so rotations that the spring/main gear makes there are a hundred cycles that the car wheels make.

The graphic shows a really simple toy where the rotation transfers into another rotation. But using more gears, cams, camshafts, and cranks we can convert the rotation into some kind of straight movement. Using Geneva drive can convert the continuous rotation into intermittent motion. And so on.

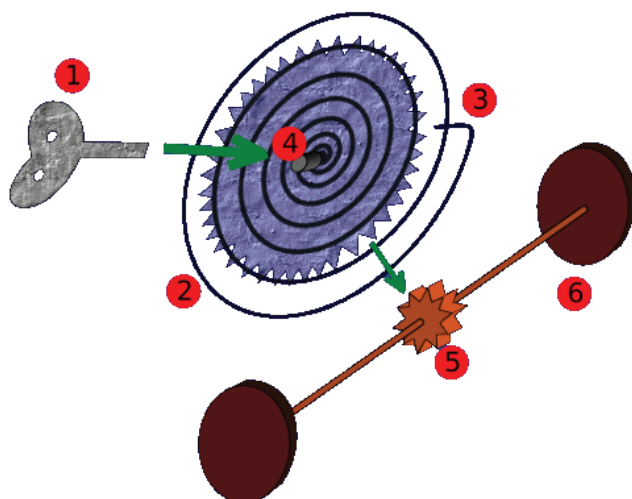

Most complex mechanical wind-up toys, and the mechanical clocks use 2 or more springs and many gears to transmit the power into complex motions.

CONCEPT 3

Fully motor operated

Features

- Fully battery and electric motor driven
- Plug in charging same as laptops
- Various speed control
- Can travel specific distance

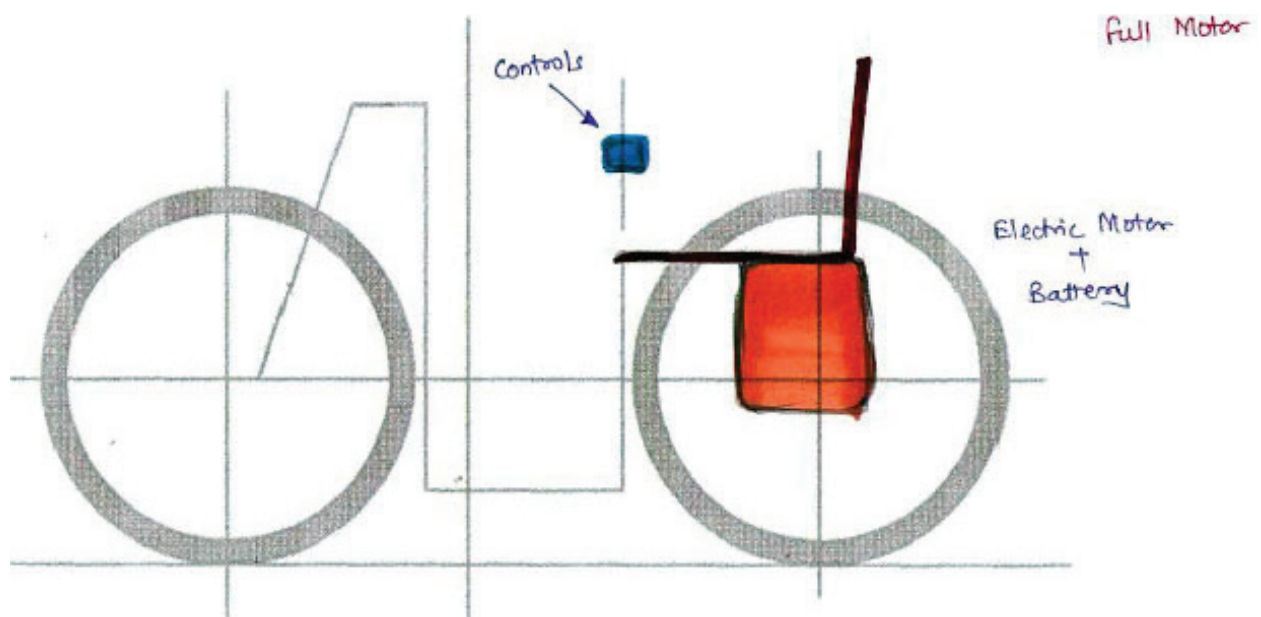

CONCEPT 4

Partial motor

Features

- Partially battery operated
- Electric motor can be used as per requirement
- Plug in charging same as laptops
- Variable speed controls
- Battery can be charged by dynamo
- Can cover more distance without user getting exhausted

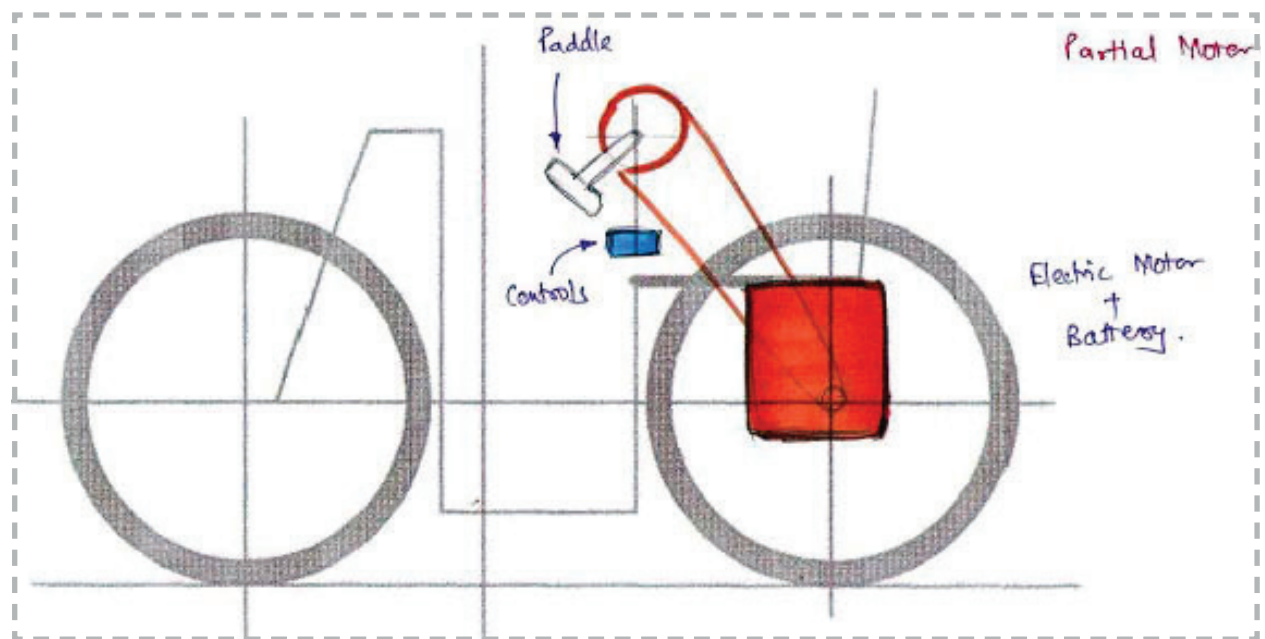

Selected concept

Reasons for selection

- Provides both manual and battery controls
- In case of a breakdown tricycle can be manually operated and does not leave the user stranded
- Simplicity of mechanism and design
- Speed up the commute on long journeys
- Apparent upgrade to the current tricycle design

CONCEPT 5

Lever free mechanism

Features

- Based on lever free wheelchair designed by MIT
- Easy operation and use of both hands
- Detachable front wheel to convert into a wheelchair for indoor use
- Smaller size
- With the front wheel attached it can be used to cover longer distances outdoors and for shorter spans or indoors the front wheel can be detached and used

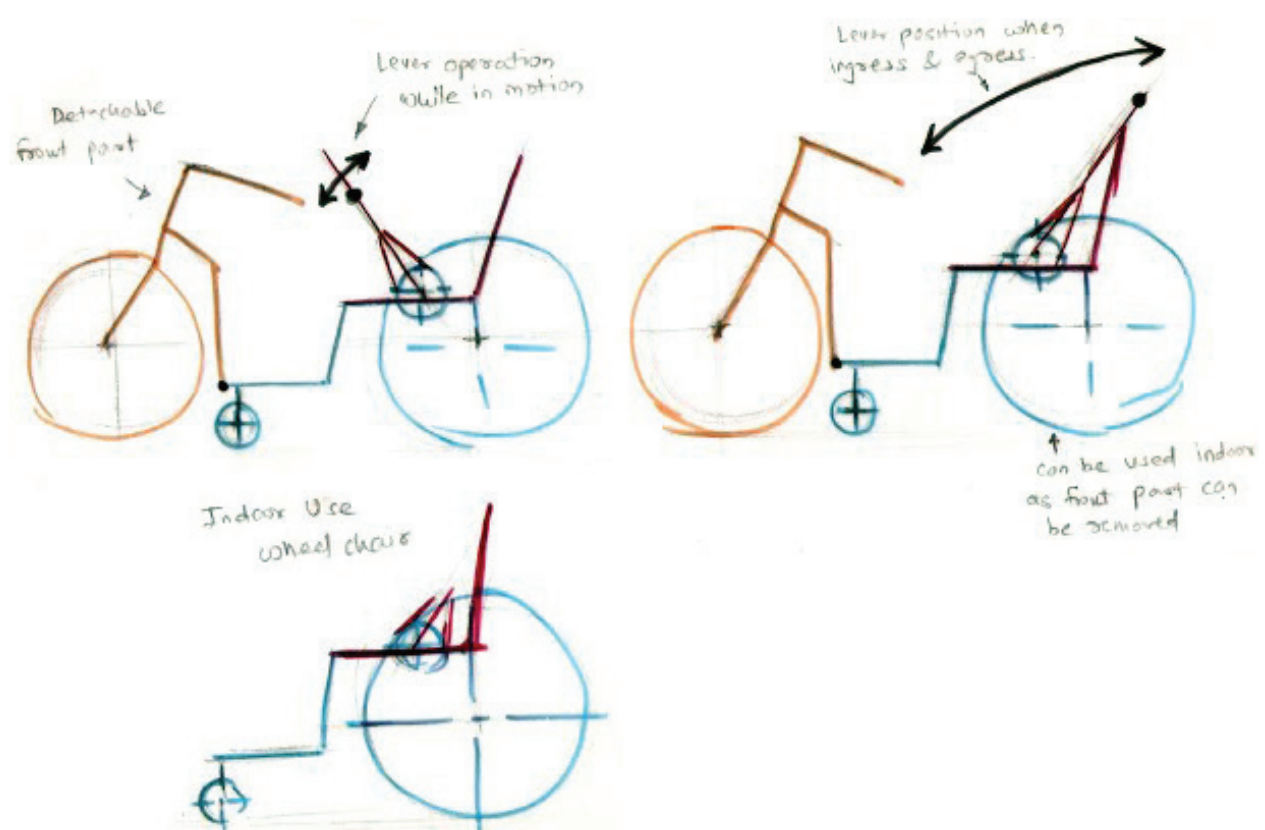
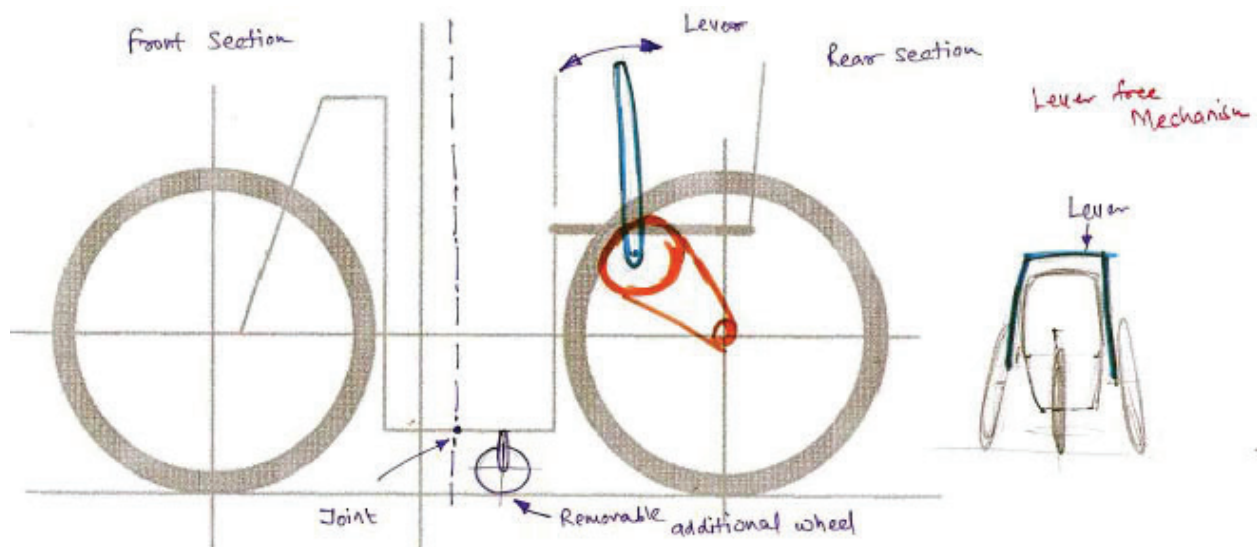

- Push button and unlock handle can be used
- Front part can be made detachable to use as wheelchair indoors
- Compact in size and simple to use
- Wheel side rims can be kept to use indoor
- Lever push bar can be made removable to use the wheelchair indoors
- Extra lever push to front side will apply brakes
- Both hands can be used when more force is needed
- Handle can be made hard to maintain position and direction while both hands are using lever
- No need to provide brakes on front wheel
- Additional smart wheel type motor can be provided for very long distance run

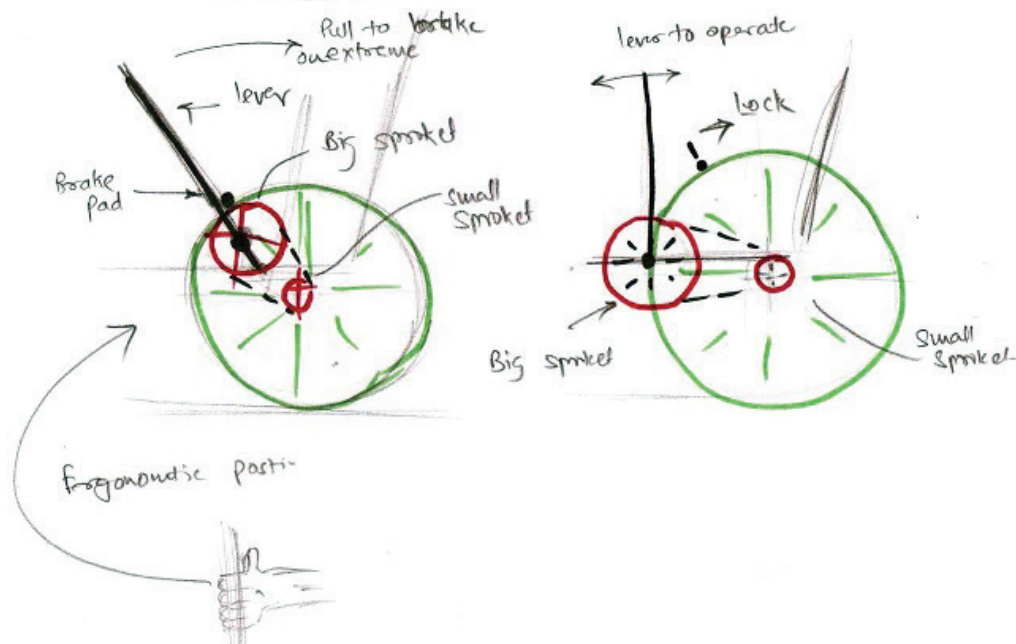
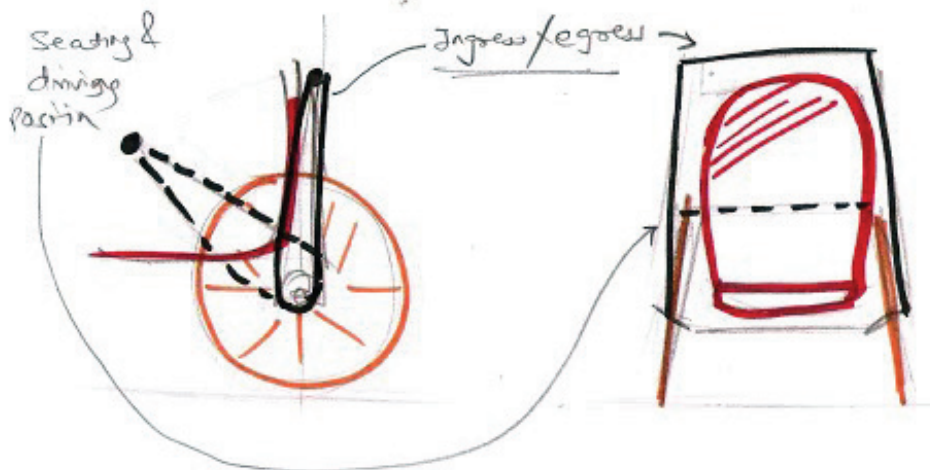
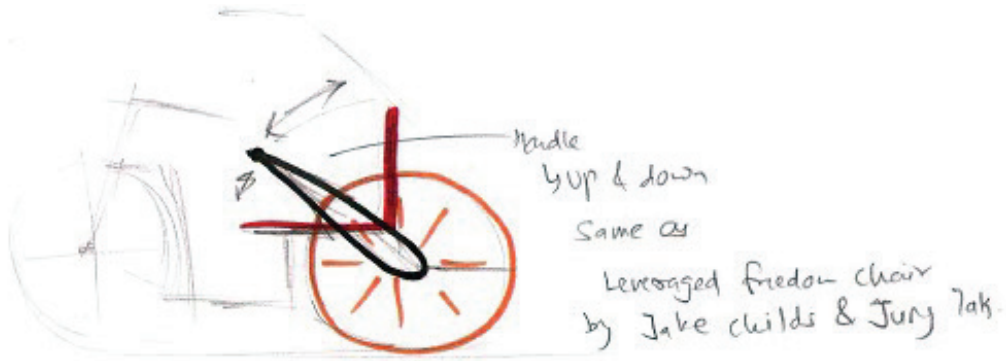

CONCEPT 6

Helical torsion spring

Features

- Partially helical torsion spring powered vehicle
- Energy can be stored in coil and can be used as per requirement
- Property of helical torsion spring- Rotation, Compression
- Re-compression can be done after utilization of energy

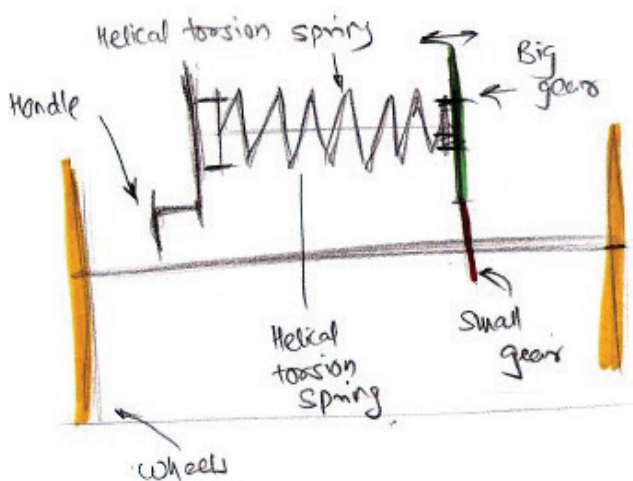
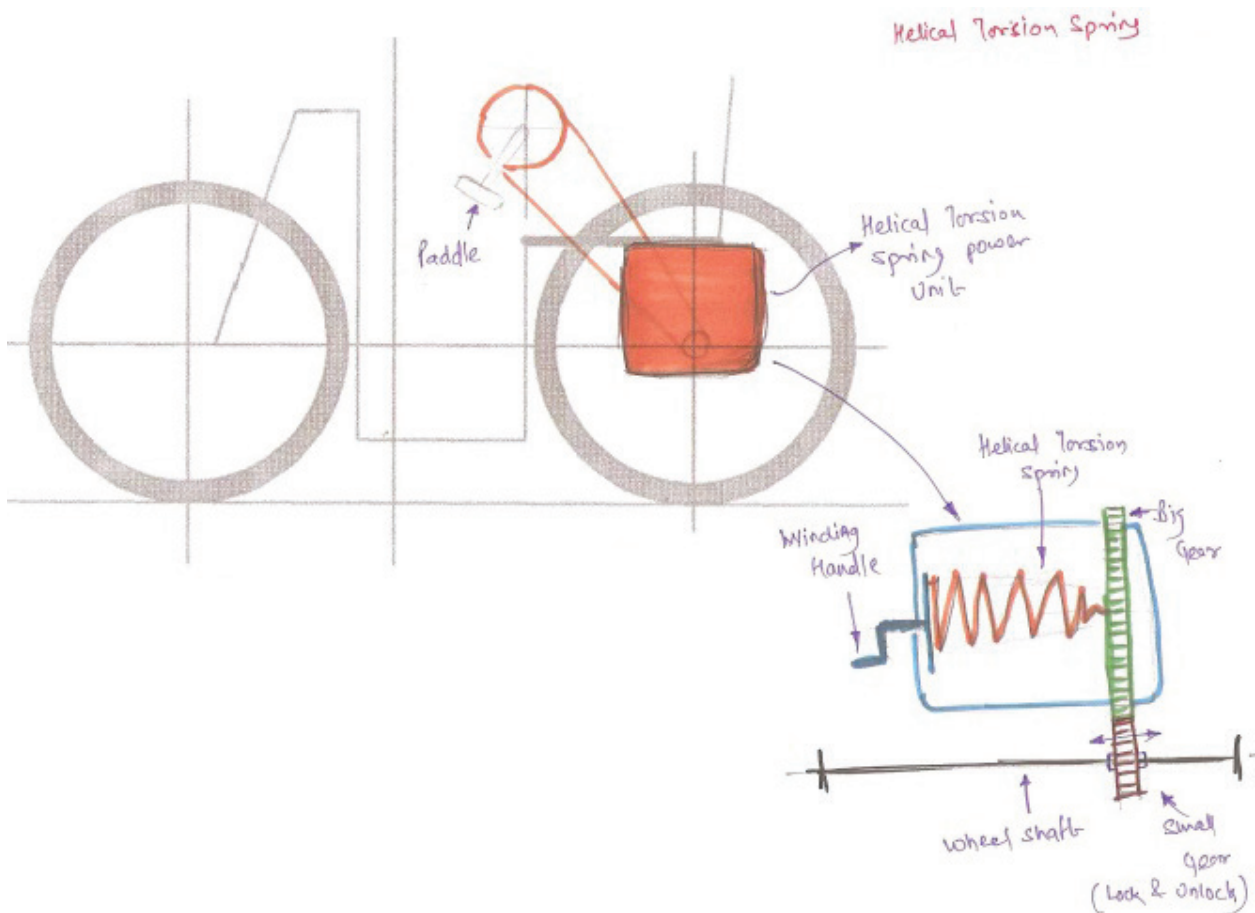

- Rotation of handle stores torque into helical spring by locking its movement in one direction
- When brake is applied and released that energy can be used to propel the vehicle
- Can be used partially as a power source
- And before leaving this energy can be stored by hand or external help

CONCEPT 7

Power pumper mechanism

Power Pumper is a ride-on toy designed for use by children with physical or neurological disabilities. It is propelled by a push-pull rowing motion powered by using arms and legs, legs only, or arms only.

It is operated by pulling the “pumper arm” towards you and then pushing it away with your feet. The Power Pumper can be used by a child with limited motor skills; and a child that has little or no lower extremity strength can use only their arms to set the product in motion.

Features

- Working same as Power pumper therapeutic tricycle
- Use of both hands
- Easy operation and movement of vehicle
- Can travel long distance
- It offers therapeutic benefit for the upper body
- Gears can be used to reduce efforts

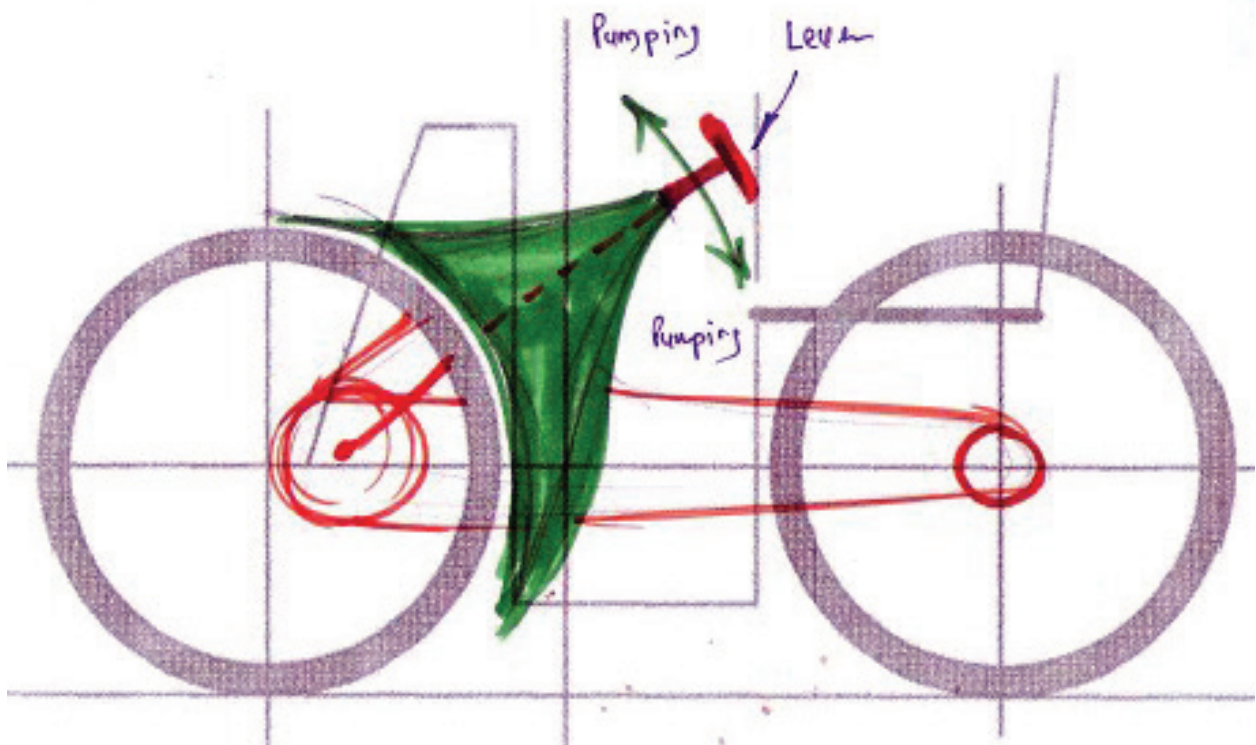

FRAME OPTIONS

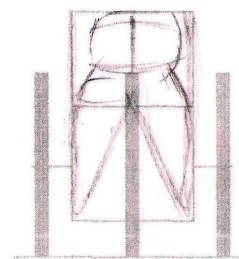
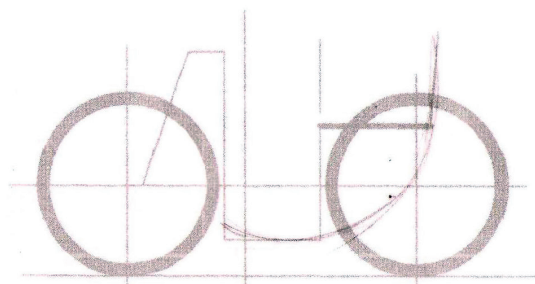
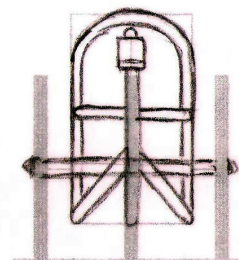
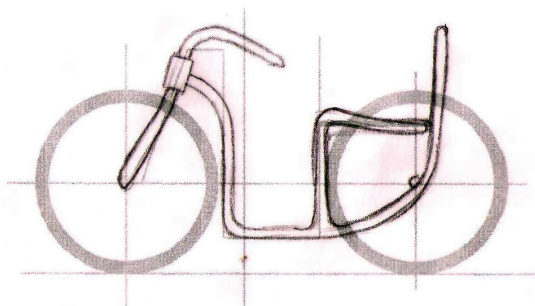
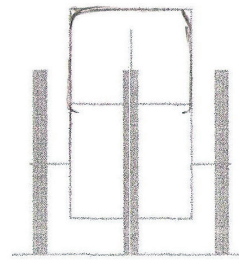
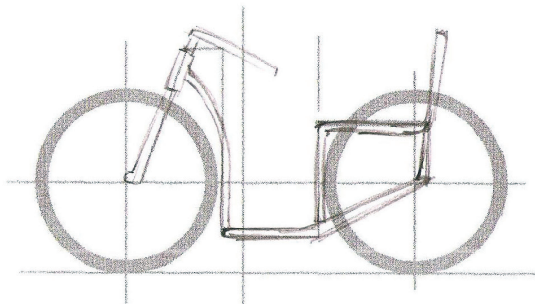
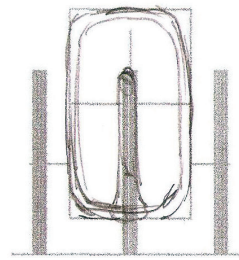
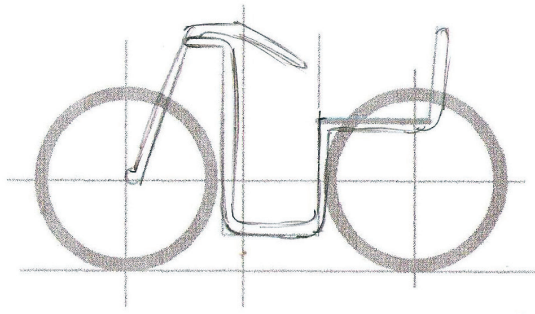

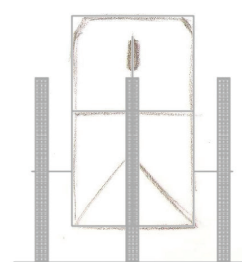
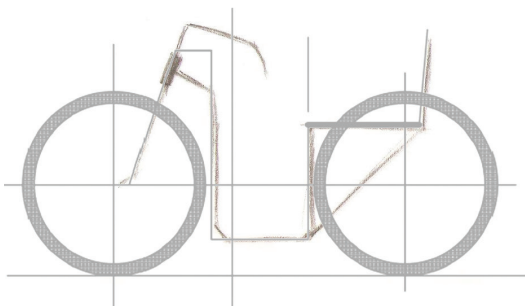
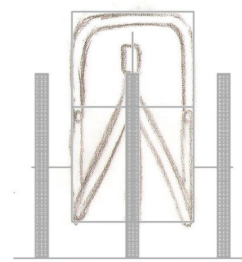
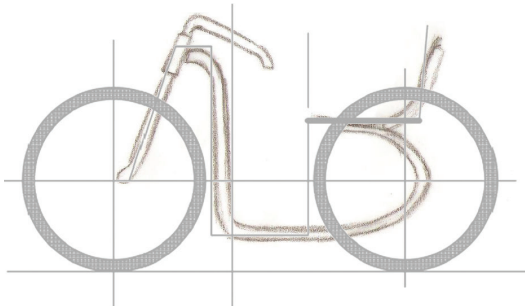
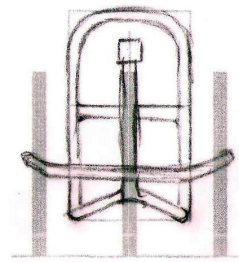
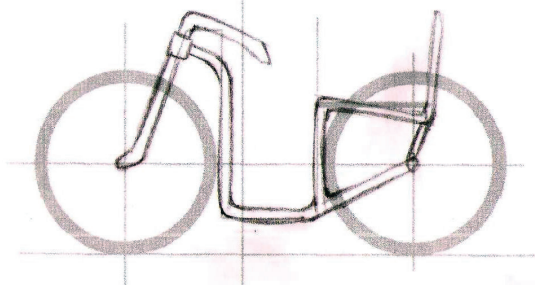
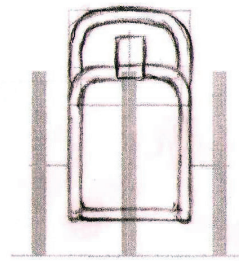
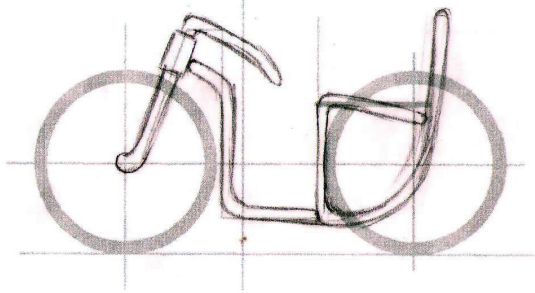

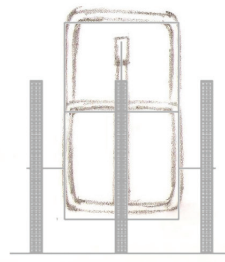
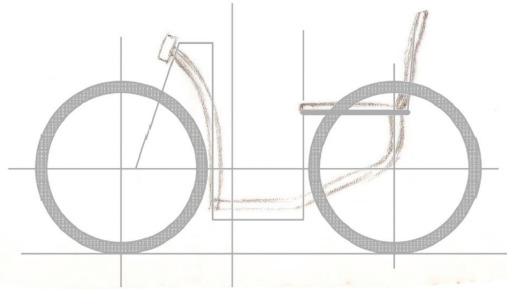
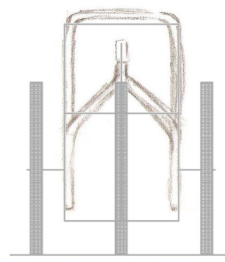
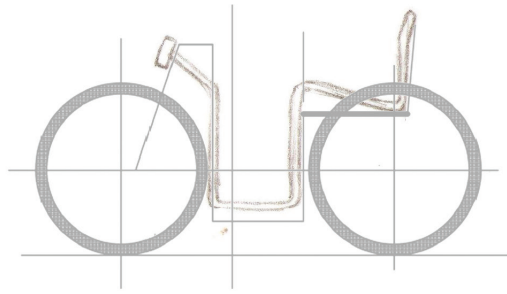

Selected frame option

Reasons for selection

- Less number of joints and bends
- More ergonomical
- Less number of frame members
- Light weight
- Aesthetically more appealing

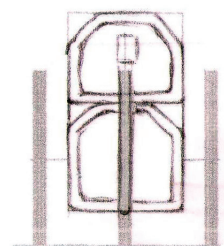
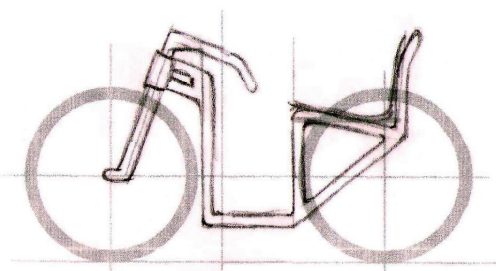
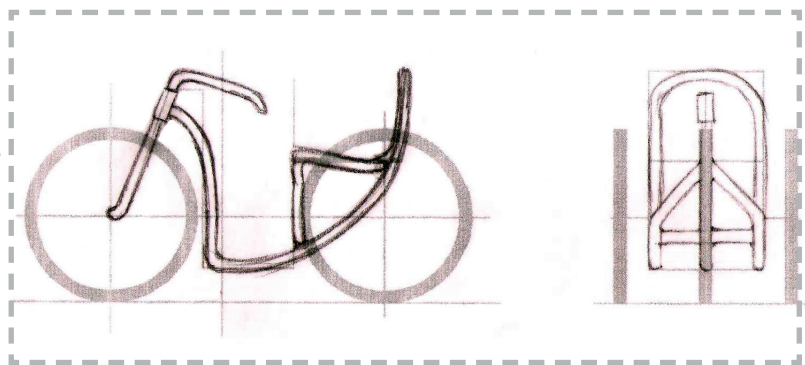

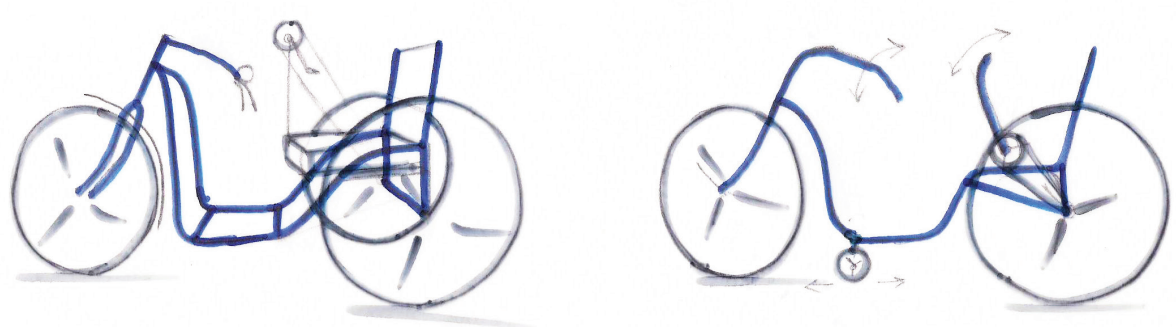
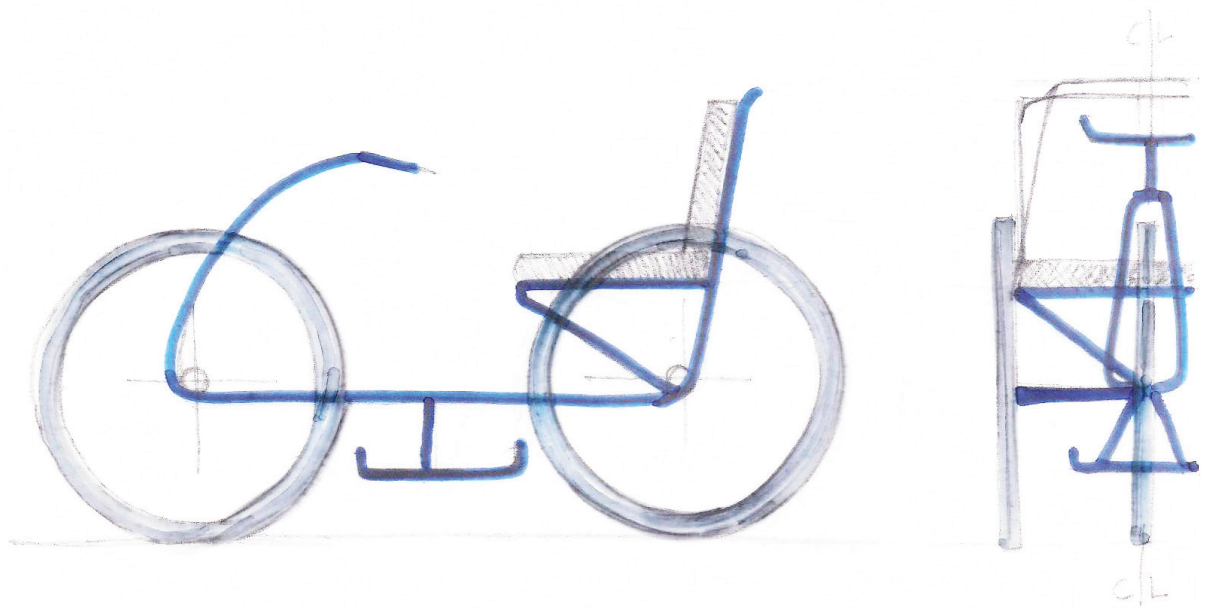
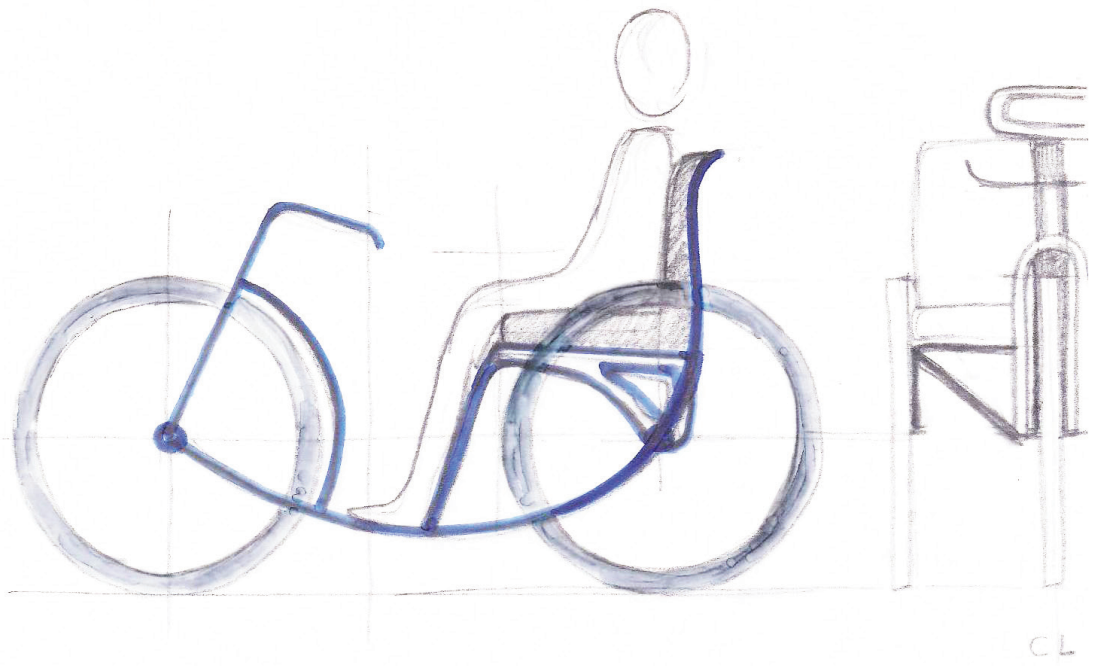

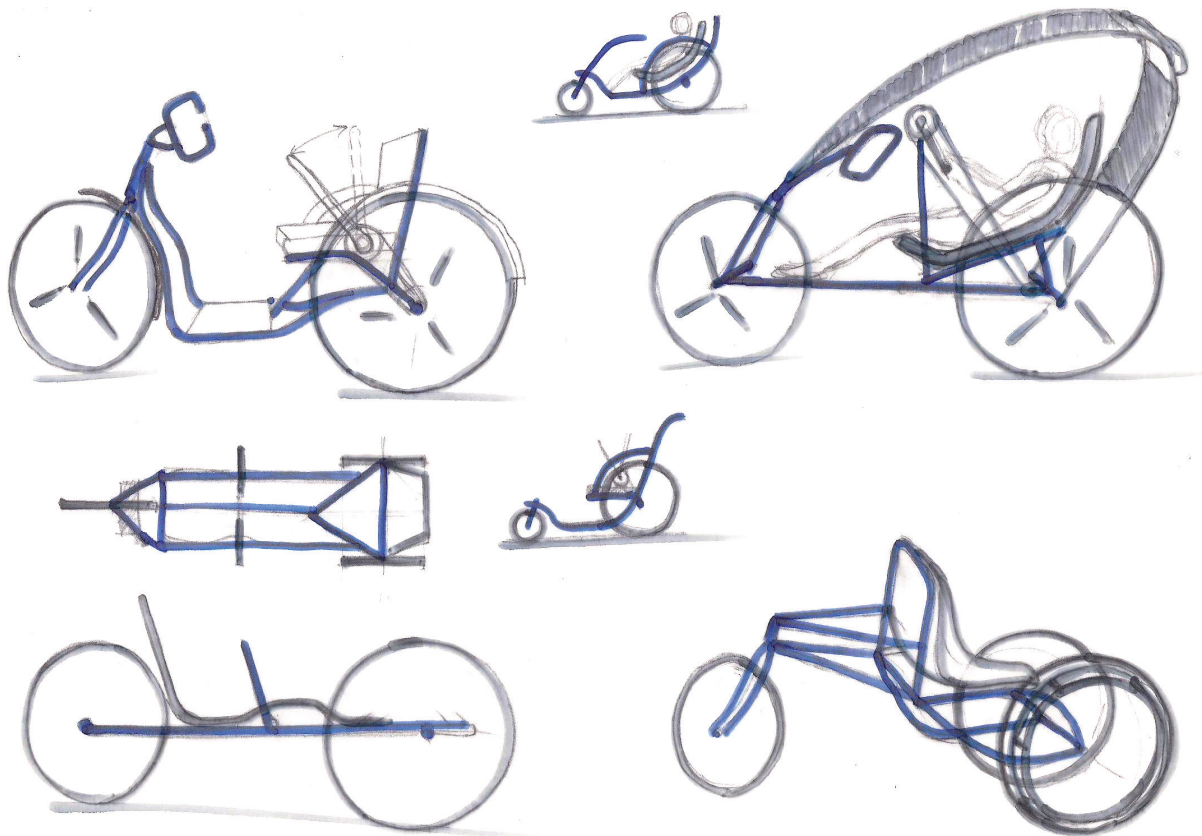
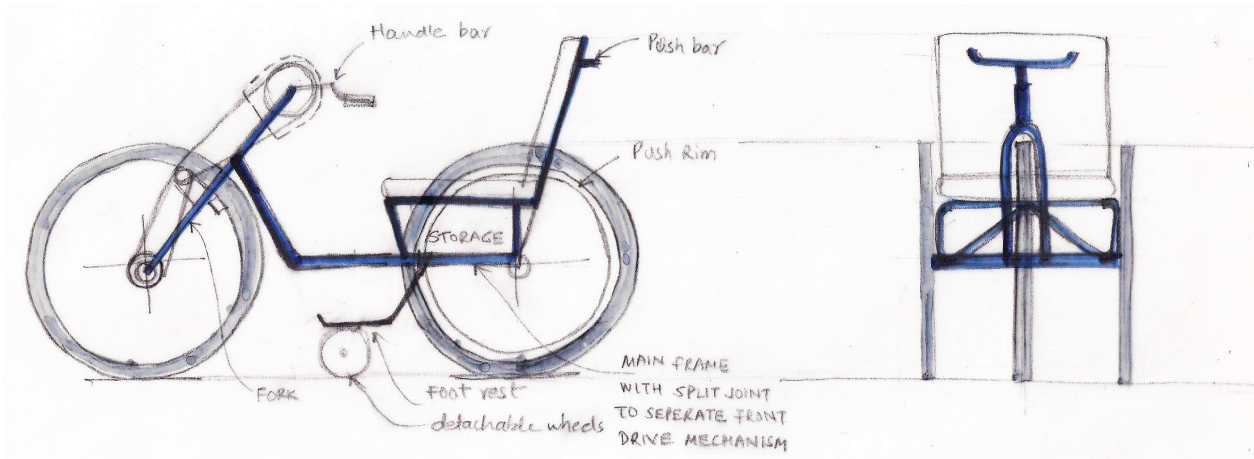

DETAIL SKETCHES

Foot rest detailing

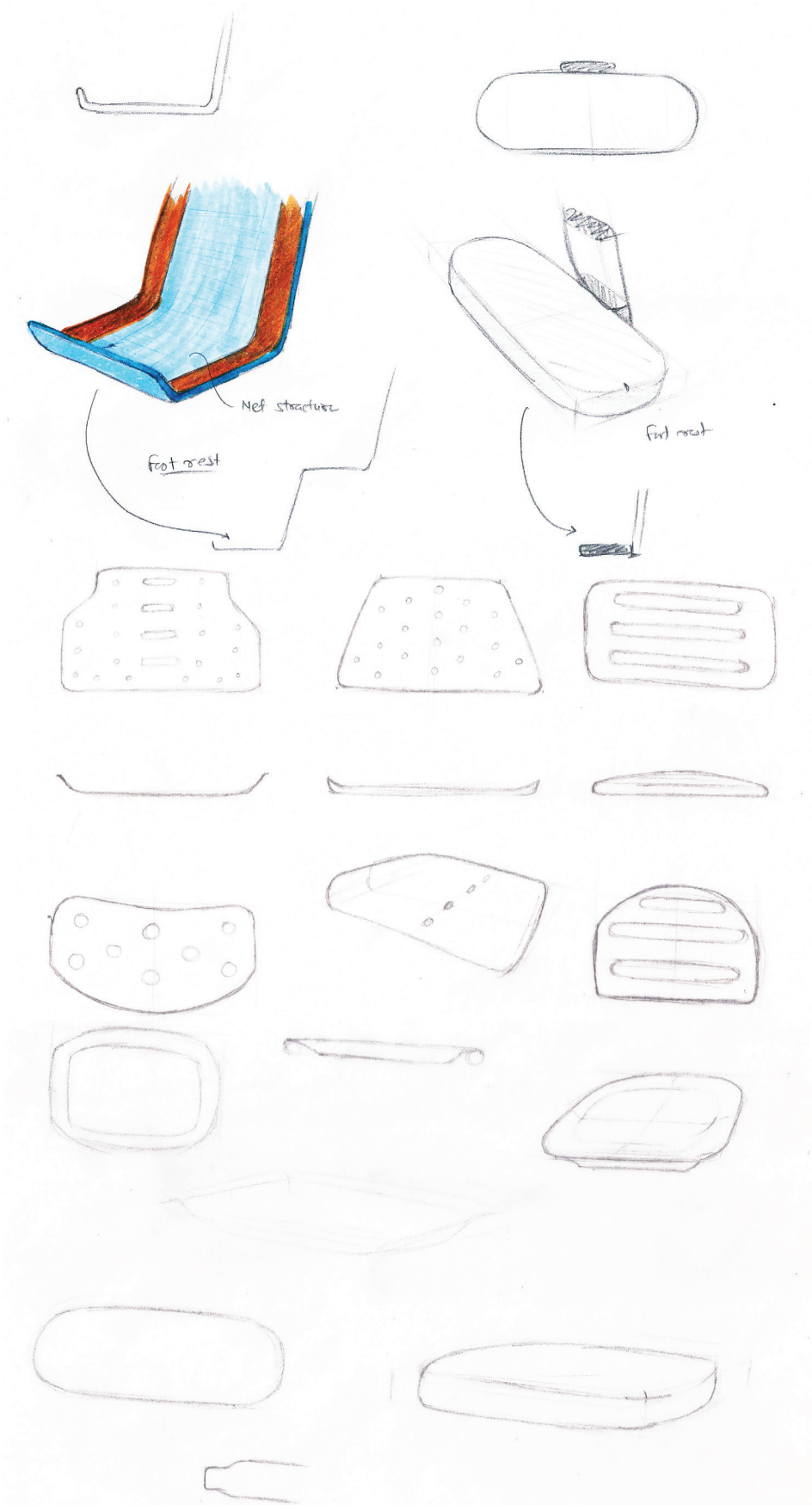

DETAIL SKETCHES

Hand pedal detailing

Features

- Hand pedal with wrist rest for support
- Soft grip
- Ergonomic form
- Brake operating button on the hand pedal

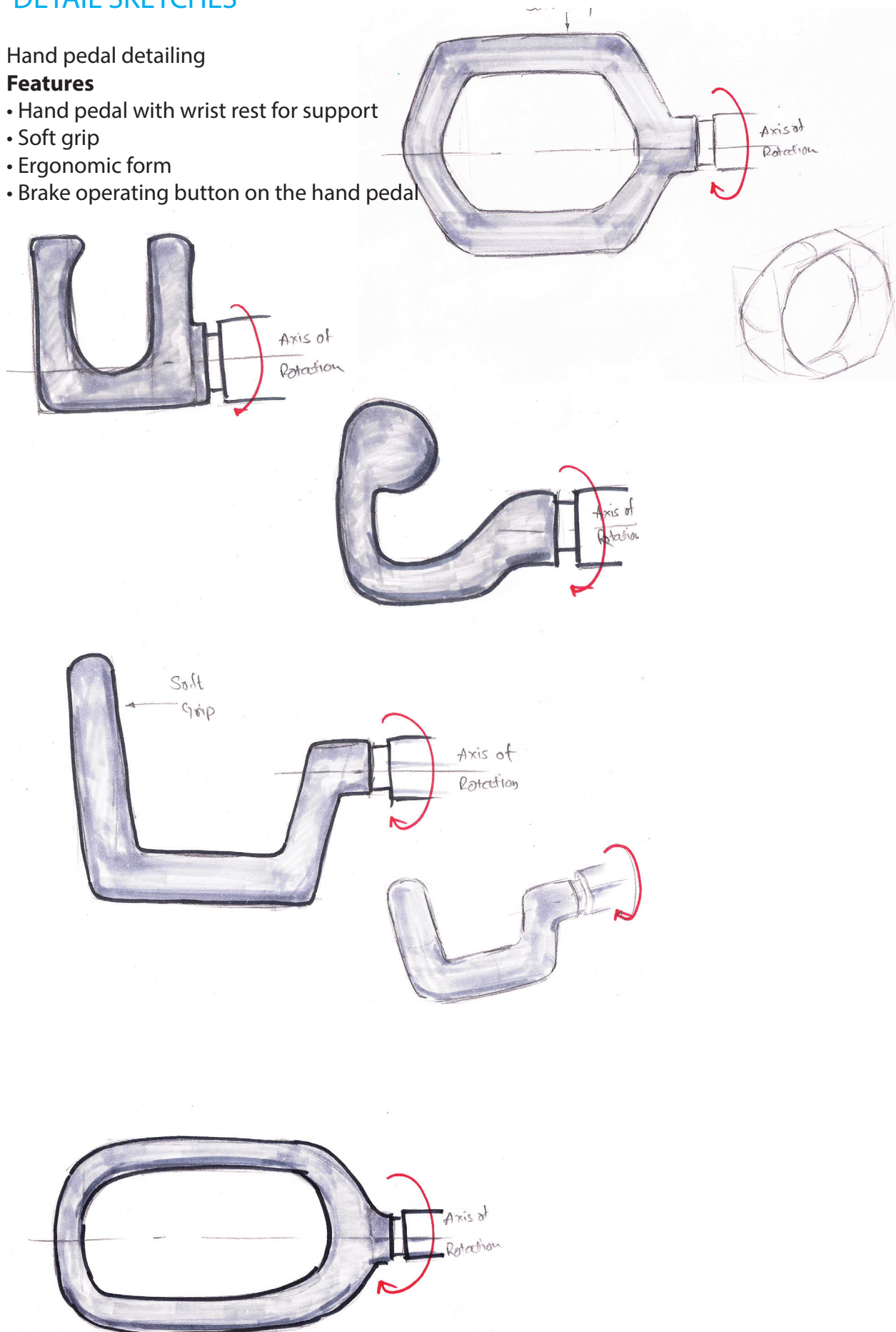

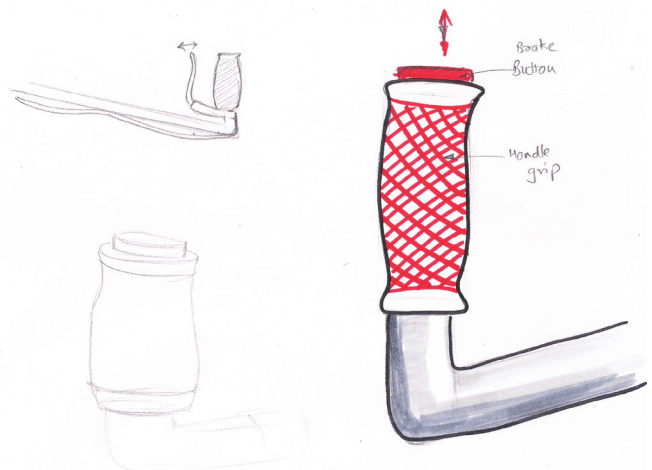
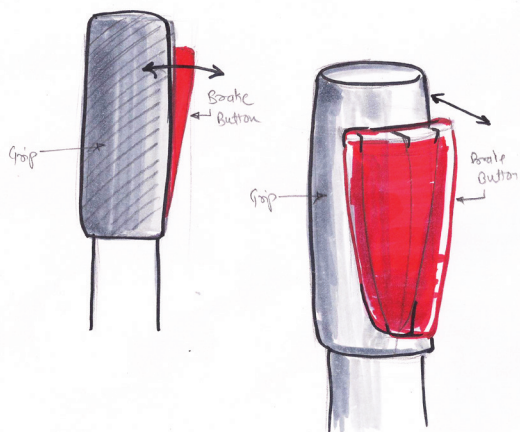
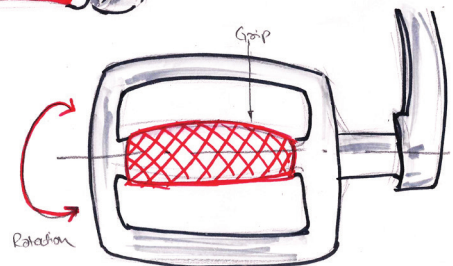
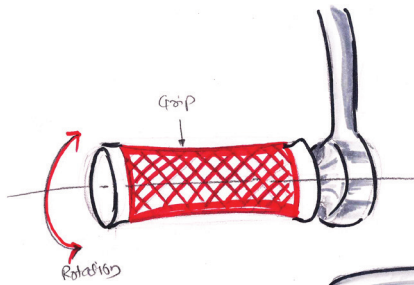
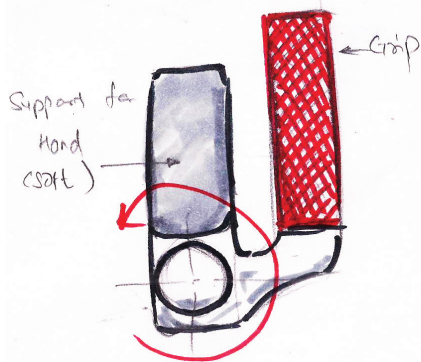
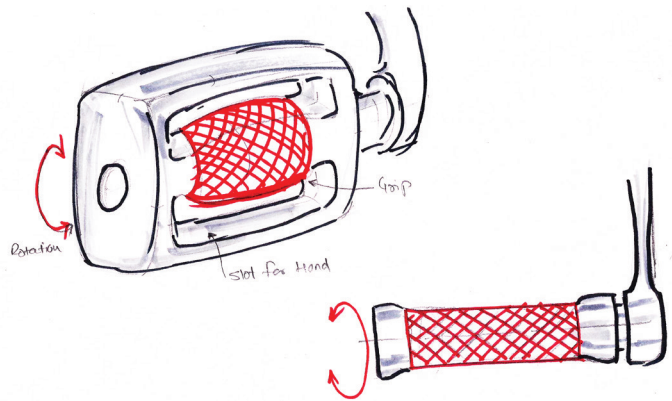
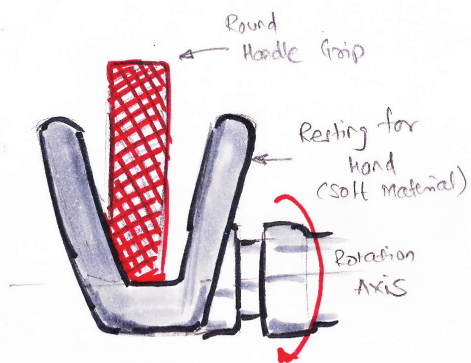

SEATING DETAIL

Tricycle seat detailing

Features

- Side supports to prevent slipping
- Adequate back and lumbar support
- Ergonomic form
- Space for easy hand pedalling

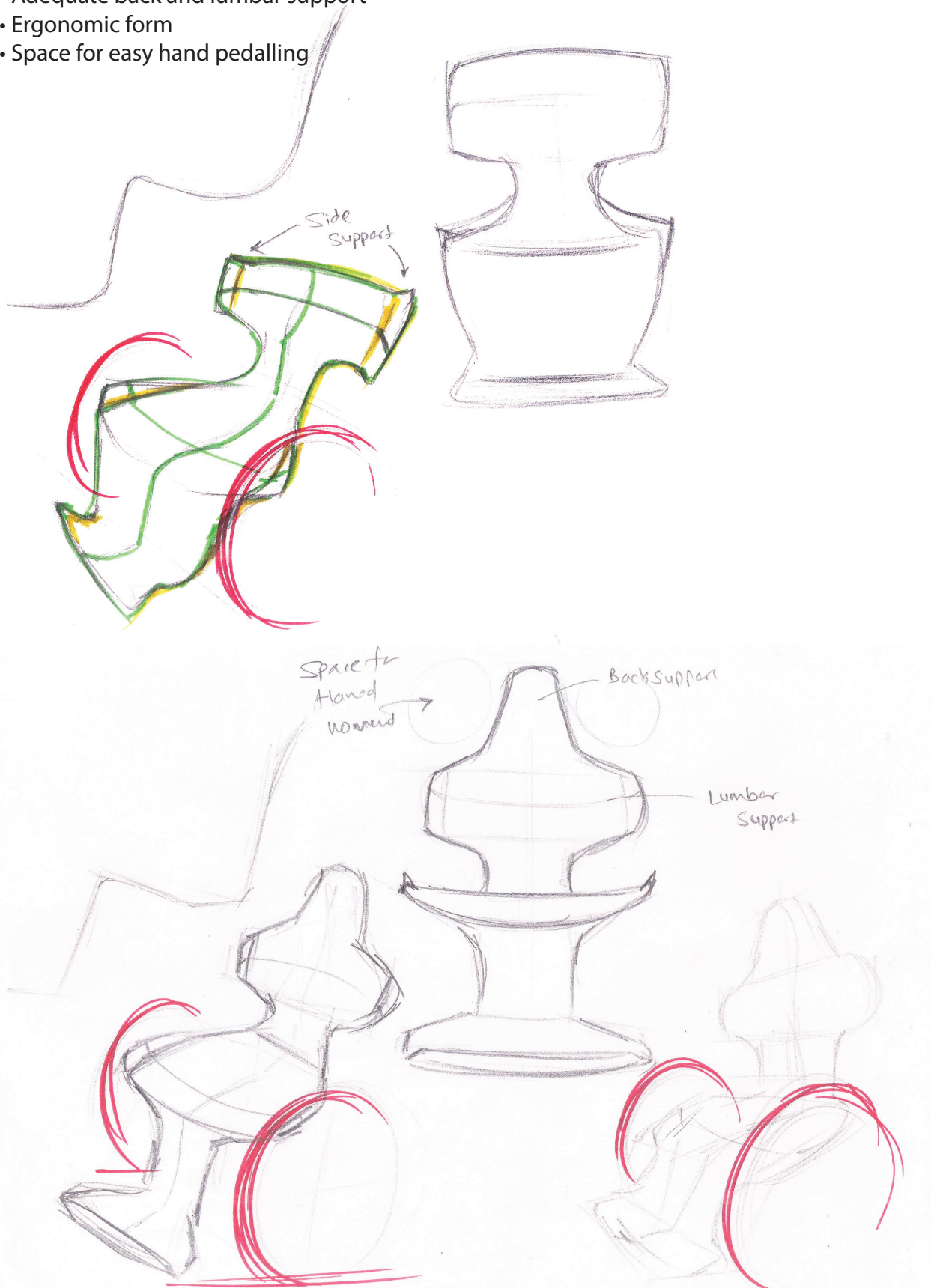

D I G I T A L M O D E L



REV : Hand propelled partially motor driven tricycle

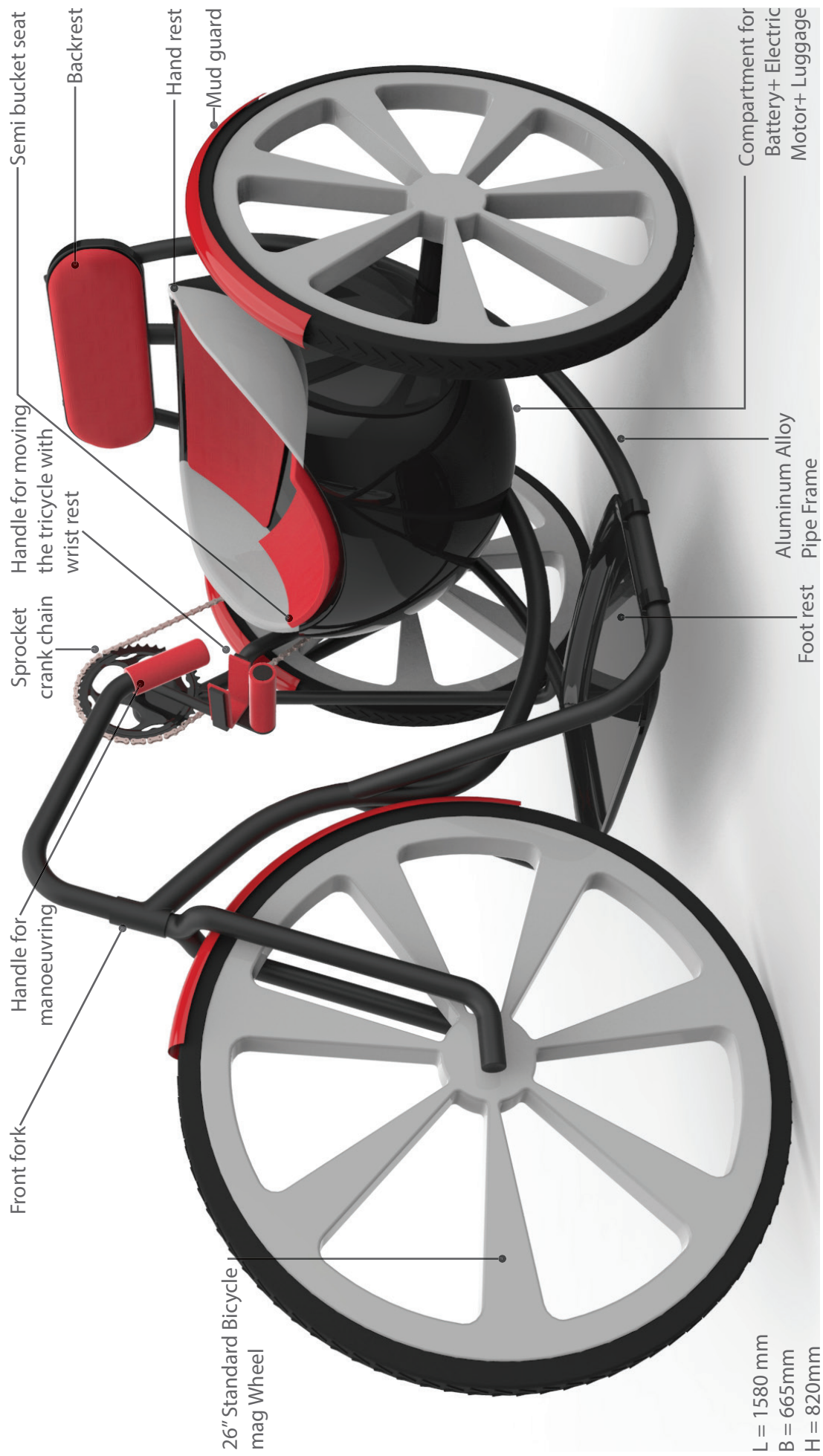

REV : Hand propelled partially motor driven tricycle

Features

1. Light weight aluminium alloy pipe frame
2. Partially motor driven working
3. Comfortable semi bucket seat
4. Detachable hand rest for ease ingress/egress
5. Comfortable paddle handle design
6. Coaster brakes for easy operation
7. Easy manufacturing
8. Hit point free design
9. Luggage space
10. Easily affordable

Detachable Hand rest for ease in ingress/ egress

Detachable Seat for maintenance and luggage

Compartment for Battery + Electric Motor + Luggage
Material: FRP

Coaster brakes



PACKAGE

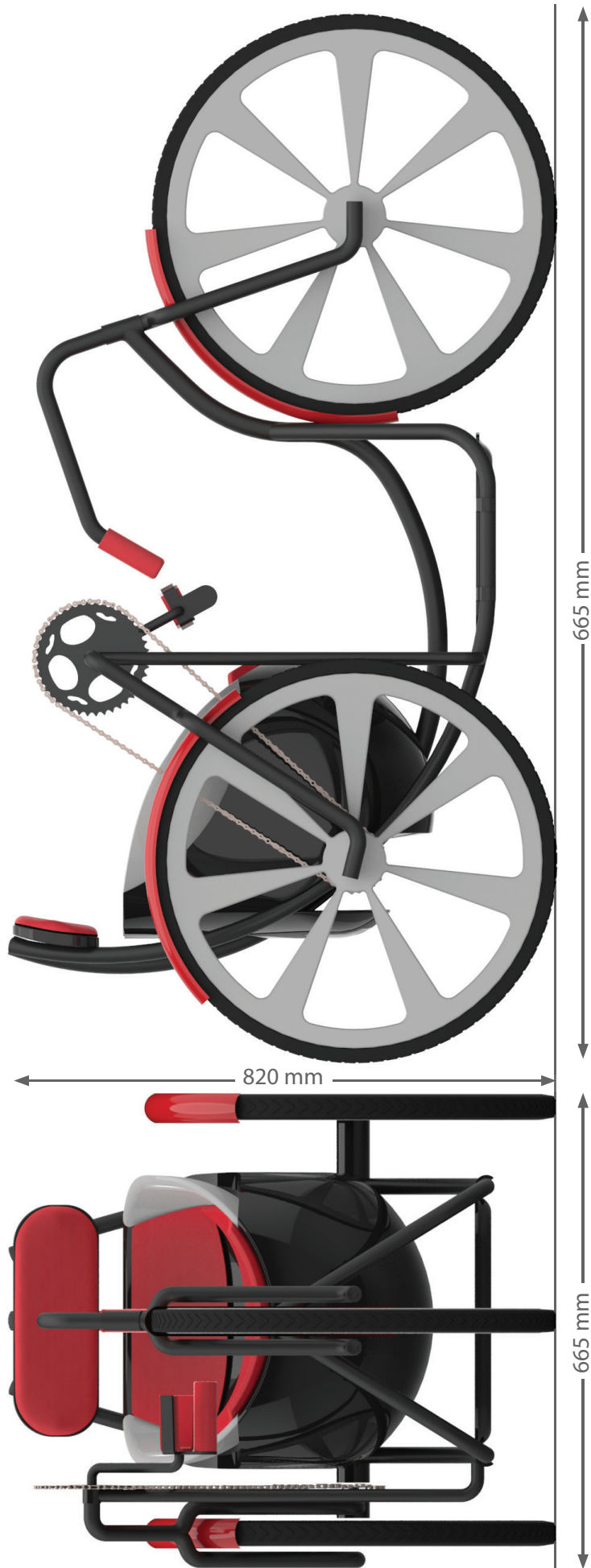

COLOURWAYS



DETAILS



Coaster brakes for rear wheel

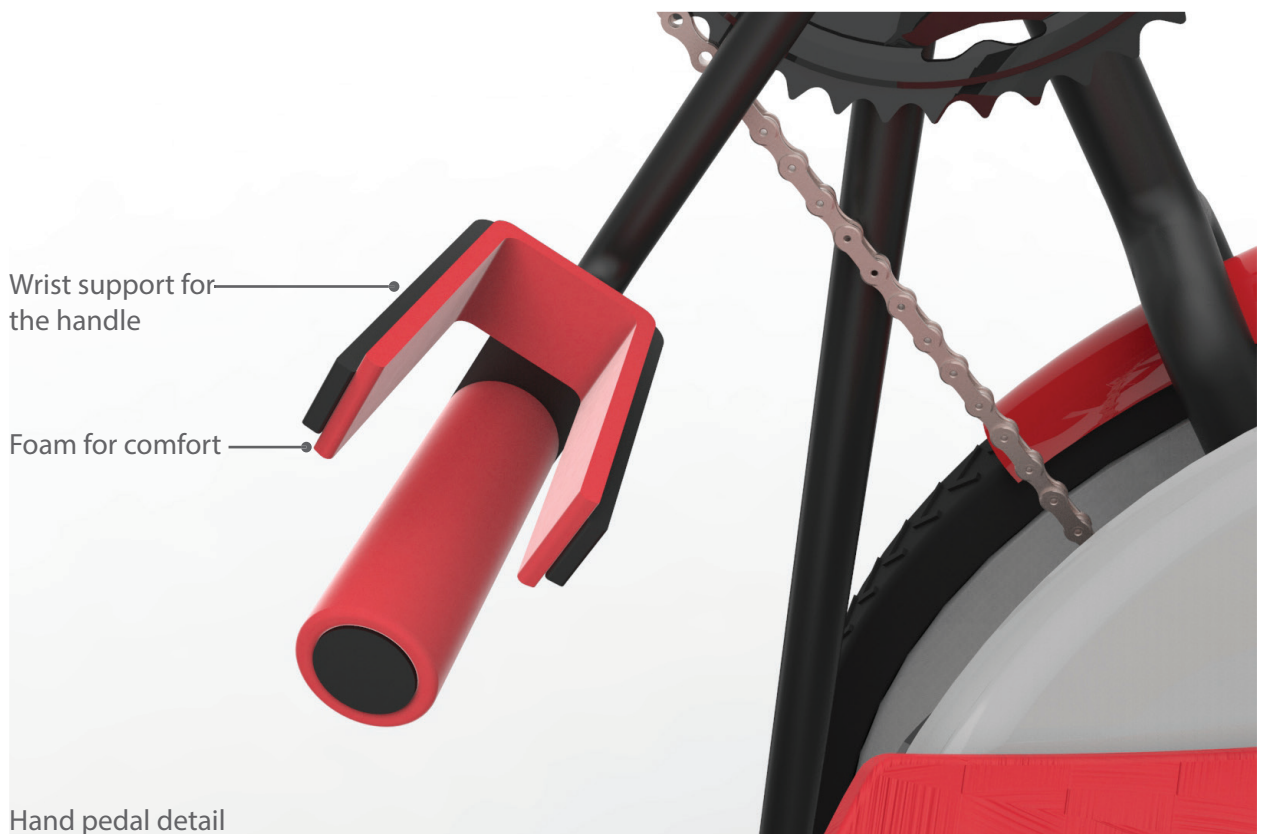

Wrist support for
the handle

Foam for comfort

Hand pedal detail

COASTER BRAKES

Also known as a back pedal brake or foot brake, is an offshoot of the drum brake integrated into hubs with an internal freewheel. Freewheeling functions as with other system, but, when back pedaled, the brake engages after a fraction of a revolution. It can frequently be found in both single speed and geared hubs.

It is a special rear hub for a bicycle, which performs two functions:

1. It allows the bicycle to roll without forcing the pedals to turn. This is the “coaster” part. It is similar in function to a freewheel, but uses a different sort of mechanism to accomplish it.
2. It is also a brake, operated by turning the pedals backwards.

Advantages

- Require less maintenance
- There are no cables running
- Coaster brakes can be a good choice for handicapped riders who lack sufficient hand strength, or for arm amputees.



PROPOSED TRICYCLE DESIGN SEATING DETAILS



PROPOSED TRICYCLE DESIGN FOOTREST DETAILS

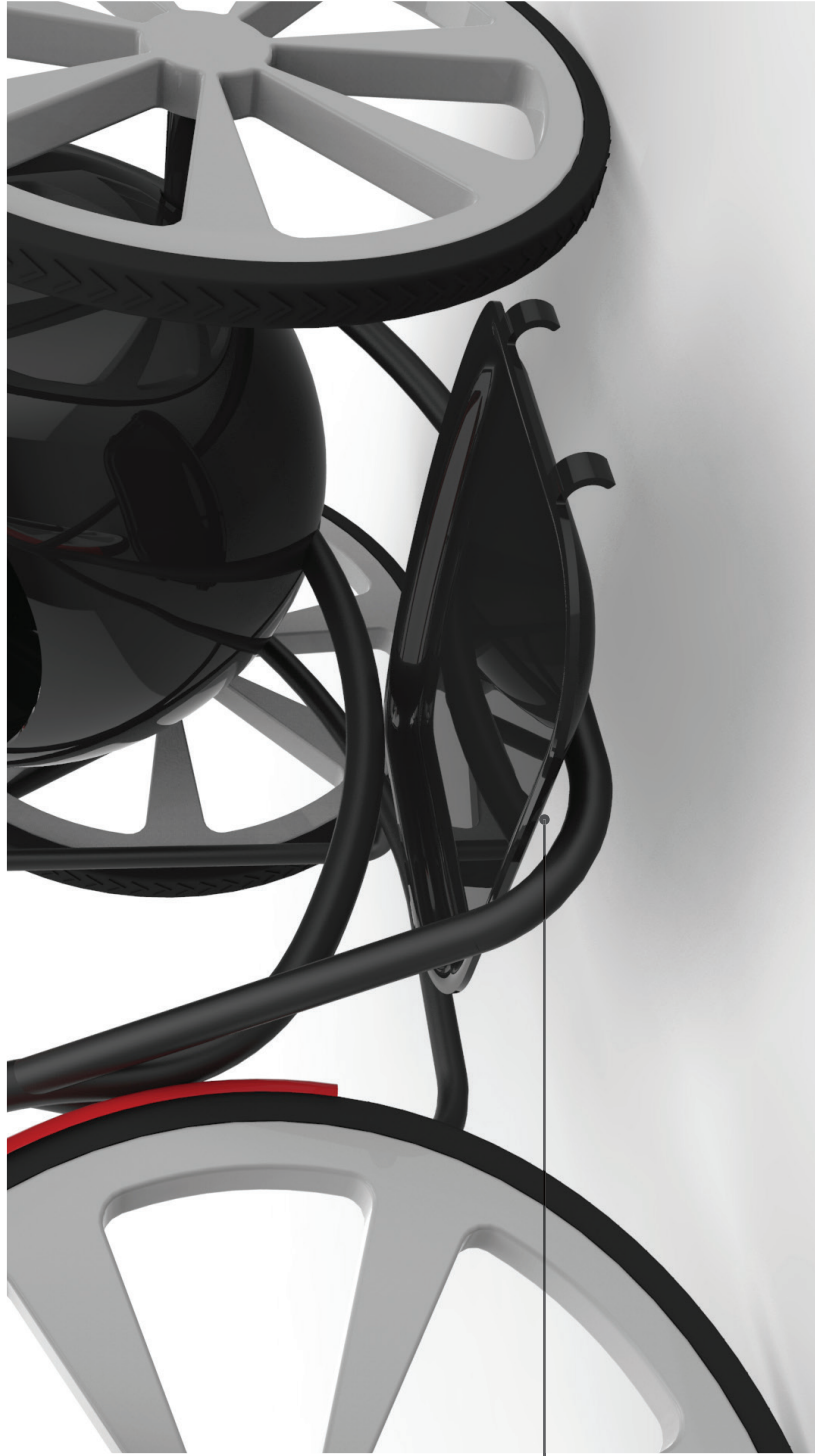

Detachable
footrest for ease
of cleaning



Easy in mounting
and bucket
shape for
keeping stuff

PROPOSED TRICYCLE DESIGN SEATING FRAME DETAILS

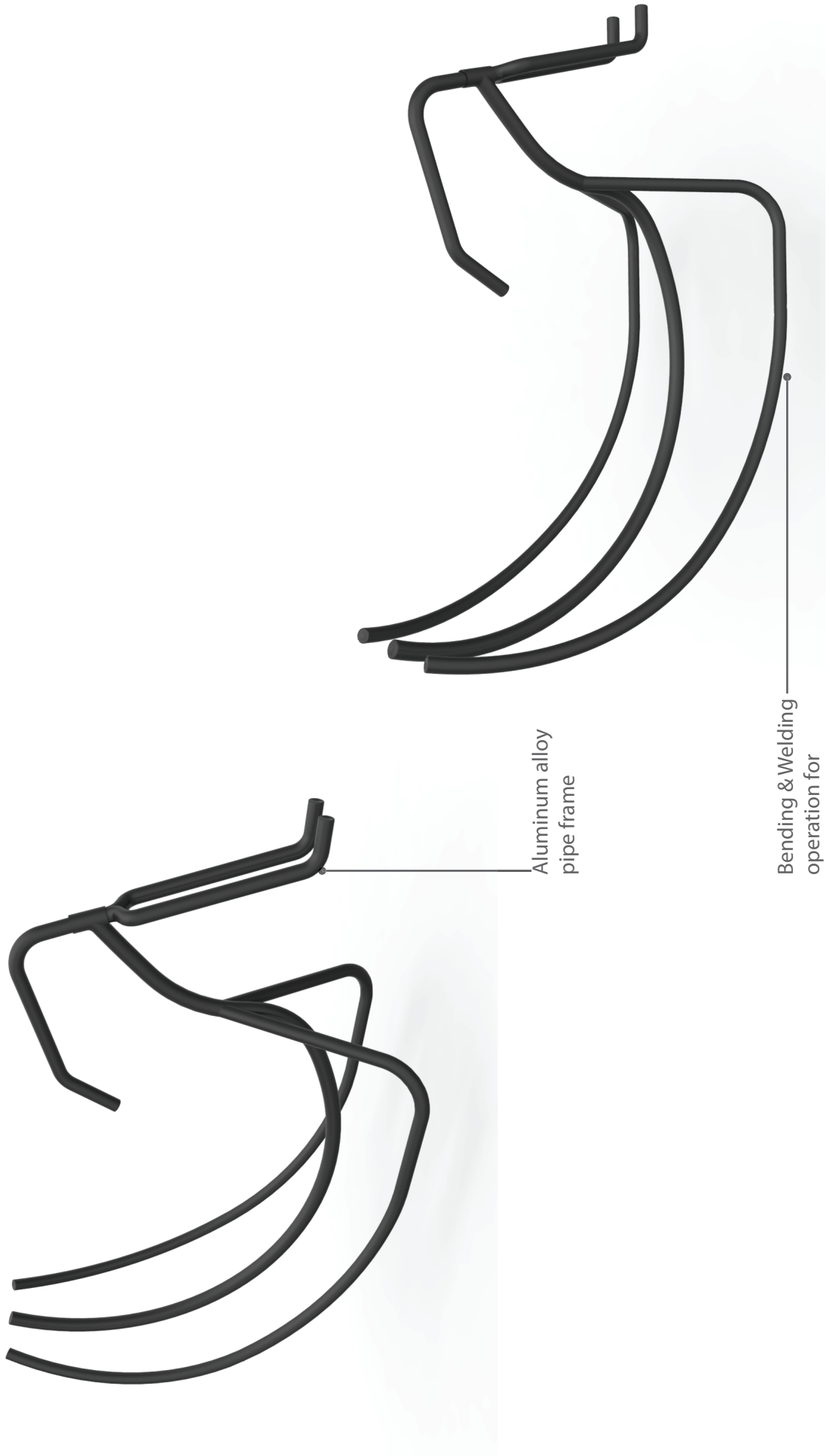

REV

The design thus developed is a hybrid tricycle which can be hand pedaled as well as used with the help of the motor. The name selected for the tricycle was "Rev" as it implies the revolution of a motor as well as to accelerate or increase the speed. The new design transforms the everyday hand pedaled tricycle livelier, productive and active. The name selected translates the design intent to the tricycle.



CONCLUSION

CONCLUSION

The design of a mode of transportation for mobility impaired person was a challenging task, as it has complexity in terms of understanding the user needs, cost, manufacturing constraints.

It sensitized me towards the user needs and how to address the unstated wants and desires of the user. I got to study modest solutions applied by users in daily life to ease commute.

Understanding their lifestyle and providing effective solutions that are within their reach.

I had a chance to work on my weaknesses and discover my strengths. It also gave me the confidence to think differently and seek solutions to underlying problems.

It was a great learning experience and offered an opportunity to translate ideas into physical form. Also help me put my acquired skills to test as I prepare to embark upon my journey from a student to a design professional.

The project helped me realize my interests, strengths and potential which will help me in preparing to enter the professional world of design.

REFERENCES

GUIDELINES ON THE PROVISION OF MANUAL WHEELCHAIRS IN LESS RESOURCED SETTINGS

William Armstrong, Johan Borg, Marc Krizack, Alida Lindsley, Kylie Mines, Jon Pearlman, Kim Reisinger, Sarah Sheldon
(World Health Organization 2008)

NOTHING ABOUT US WITHOUT US

Developing Innovative Technologies

For by and with disabled persons

ERGONOMICS FOR CHILDREN

Designing Products And Places For Toddlers To Teens

Edited by Rani Lueder and Valerie Berg Rice

DISABLED VILLAGE CHILDREN A Guide for Community Health Workers, Rehabilitation Workers, and Families

David Werner with the help of many friends

WHEELCHAIRS IN INDIA 'ABLING' THE DISABLED

i² Knowledge Services

INDIAN ANTHROPOMETRIC DIMENSIONS - FOR ERGONOMIC DESIGN PRACTICE

Dr. Debkumar Chakrabarti

DESIGN MEETS DISABILITY

Graham Pullin

ULTIMATE BICYCLE BOOK

Richard Ballantine, Richard Grant

ERGONOMICS IN DESIGN, Fall 2008

Global Ergonomic

DESIGN DATA FOR WHEELCHAIR CHILDREN

Brian C Goldsmith

YOUNG CHILDREN WITH SPECIAL NEEDS

McGovern

Nancy H Fallen with E.

DOWN TO EARTH 1-15, 2010

Magazine Issue: February

THE WHEELCHAIR CHILD

Philippa Russell

THE HANDICAPPED CHILD

Grace E. Woods

ACCESSIBLE ENVIRONMENTS: Toward Universal Design Hardie, Jaine P. Place

Ronald L. Mace, Graeme J.

BIBLIOGRAPHY

- Types of Wheelchairs. <http://medicalsupplies.about.com/od/Hospital-Equipment/a/18-Types-Of-Wheelchairs.htm> (Page nos. 32-36)
- Bicycle Coaster Brakes. <http://sheldonbrown.com/coaster-brakes.html> (Page 113)
- Bicycle Design. <http://bicycledesign.net>
- Indian Anthropometric Dimensions. National Institute of Design- Debkumar Chakrabarty (Page no. 86, 87)
- Disabled Population. http://censusindia.gov.in/Census_And_You/disabled_population.aspx Page no. 16,17)
- Durable Wheelchairs Best Material. <http://www.karmanhealthcare.com/blog/2013/07/30/durable-wheelchairs-best-material/> (Page no. 38-41)
- Freedom Chair. <https://www.kickstarter.com/projects/gogrit/freedom-chair-the-adaptive-all-terrain-mobility-ma>
- Geometry of Bike Handling. <http://calfeedesign.com/tech-papers/geometry-of-bike-handling/>
- Goldsmith, S. (2000). Universal Design Woburn: Plant A Tree.Handicapped People. <http://www.handicappedpeople.com/home.aspx>
- Leveraged Freedom. <http://www.core77.com/posts/18507/case-study-leveraged-freedom-chair-by-amos-winter-jake-childs-and-jung-takenabling-freedom-for-the-disabled-in-developing-countries-18507>
- Leveraged Freedom Chair. <http://continuuminnovation.com/work/leveraged-freedom-chair/>
- Leveraged Freedom Chair. Global Research & Innovation Technology: <http://gogrit.org/>
- Manual Wheelchair Design. <http://www.streetsie.com/manual-wheelchair-design-production/>
- Nothing About Us Without Us. Disability Information Resources: <http://www.dinf.ne.jp/doc/english/global/david/dwe001/dwe00101.html> (Page no. 23,24,42,44,46)
- Power Pumper. <https://powerpumper.com/> (Page no. 97)
- Problem Disability Simulation. <http://www.jeffpreston.ca/2014/09/01/problem-disability-simulation/>
- Understanding Bicycle Frame Geometry. <http://cyclingabout.com/understanding-bicycle-frame-geometry/>
- Wheelchair. Wheelchair Drive: <http://www.wheelchairdriver.com/>
- Wheelchair. (2015, 4 18). Wikipedia: <http://en.wikipedia.org/wiki/Wheelchair>
- Wikipedia- history of wheelchair, history of tricycle (Page no. 30,31,54,55,58,59)