

**REPORT OF
MAJOR PROJECT
ON**

**“Rock Mass Classification and Tunnel Supporting
System using RMR and Q-system computation for
Kund Region (Okhi Math), Rudraprayag”**

SUBMITTED TO

**DEPARTMENT OF PETROLEUM ENGINEERING & EARTH SCIENCES
UNIVERSITY OF PETROLEUM AND ENERGY STUDIES
(2011-15)**

**UNDER GUIDANCE OF
Dr. UDAY BHAN
DEPARTMENT OF EARTH SCIENCE**

**SUBMITTED BY:
ABHIJEET KUMAR (R490211001)
UCHIT CHOUDHARY (R490211041)
PRADIP SINGH (R490211023)**

CERTIFICATE

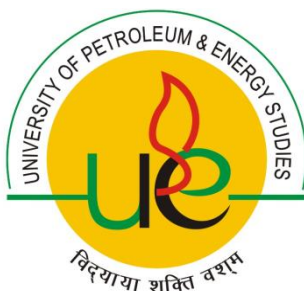

This is to certify that the project work on **“Rock Mass Classification and Tunnel Supporting System using RMR and Q-system computation for Kund Region(Okhi Math), Rudraprayag, ”**submitted to the University of Petroleum and energy Studies, Dehradun by Abhijeet Kumar (R490211001), Uchit Choudhary (R490211041) and Pradip Singh(R490211023) in partial fulfillment of the requirement for the award of degree of Bachelor of Technology in Geoscience Engineering (2011-2015), is a bonafide work carried out by them under my supervision and guidance.

This is certifying that the above statements made by the candidates are correct to best of my knowledge.

DATE: April 14th, 2015

Dr. UDAY BHAN

Dept. of Earth Sciences

DECLARATION

We hereby declare that **“Report of Major Project at University of Petroleum and Energy Studies”** is for fulfilling the requirement of Bachelor of Technology in Geoscience at **University of Petroleum and Energy Studies, Dehradun**. It is an original training/work done by us and has not been submitted to any other **Public or Private Organization** to get another certificate/award.

Submitted By:



1. PRADIP SINGH
2. UCHIT CHOUDHARY
3. ABHIJEET KUMAR

(Students of B.tech Geoscience Engineering (2011-2015) Department of Petroleum Engineering and Earth Science, University of Petroleum and Energy Studies) Dehradun-248007, India

ACKNOWLEDGEMENT

I would like to express my gratitude and appreciation to all those who gave us the possibility to complete this project at the Department of Earth Science and Petroleum at the University of Petroleum and Energy Studies, Dehradun. This project bears the imprints of the efforts extended by many people to whom we are deeply indebted.

A special thanks to our classmates who guided and supported us throughout the project.

Last but not least, many thanks go to the head of the project, DR. UDAY BHAN who has given his full effort in guiding us in achieving the goal as well as his encouragement to maintain our progress in track. He was always available for discussions at length on the various concepts that could be incorporated in the project.

Table of Contents

S.No	Particulars	Page No
1.	Certificate	2
2.	Declaration	3
3.	Acknowledgement	4
4.	Project Overview	8
5.	Chapter 1- Introduction	9
6.	Chapter 2- Rock Mass Classification	13
7.	Chapter 3- Tunnel Supporting Parameters	22
8.	Chapter 4- Field Work	27
9.	Chapter5- Observations	36
10.	Conclusion	51
11.	References	52

List of Tables

S.No	Particulars	Page No
1.	Litho logical Sequence	11
2.	Strength of Intact Rock material	14
3.	RQD (For RMR system)	15
4.	Spacing of discontinuities	15
5.	Condition of discontinuities	16
6.	Groundwater Condition	16
7.	Effect of discontinuities Strike and Dip Orientation in Tunneling	17
8.	Rating adjustment for Discontinuity Orientation	17
9.	Rock Mass Classes determined from the total rating	17
10.	RQD (For Q system)	18
11.	Joint Set number	19
12.	Joint roughness number	19
13.	Joint Alteration number	20
14.	Joint Water Reduction Factor	20
15.	SRF	21
16.	Guidelines for Excavation and Support of 10m Span in Rock Tunnels	26
17.	Values of Strike & Dip direction and Dip amount	33-35

List of Figures

S.No	Particulars	Page No
	Hydroelectric Projects on River Mandakini	9
2.	Division of Himalaya	10
3.	Procedure for measurement and Calculation of RQD	14
4.	Typical setup for creating Resin anchored and grouted Rock bolt	23
5.	Chain link mesh	24
6.	Welded wire mesh	24
7.	Steel support system	25
8.	Hammers	28
9.	Types of compass	30
10.	Joint set Identification	32
11.	Stereonet showing Dip direction	32
12.	Facelog 1 showing Q Computation	36
13.	Facelog 1 showing RMR Computation	37
14.	Stereonet of Facelog 1	38
15.	Facelog 2 showing Q Computation	39
16.	Facelog 2 showing RMR Computation	40
17.	Stereonet of Facelog 2	41
18.	Facelog 3 showing Q Computation	42
19.	Facelog 3 showing RMR Computation	43
20.	Stereonet of Facelog 3	44
21.	Facelog 4 showing Q Computation	45
22.	Facelog 4 showing RMR Computation	46
23.	Stereonet of Facelog 4	47
24.	Facelog 5 showing Q Computation	48
25.	Facelog 5 showing RMR Computation	49
26.	Stereonet of Facelog 5	50

PROJECT OVERVIEW



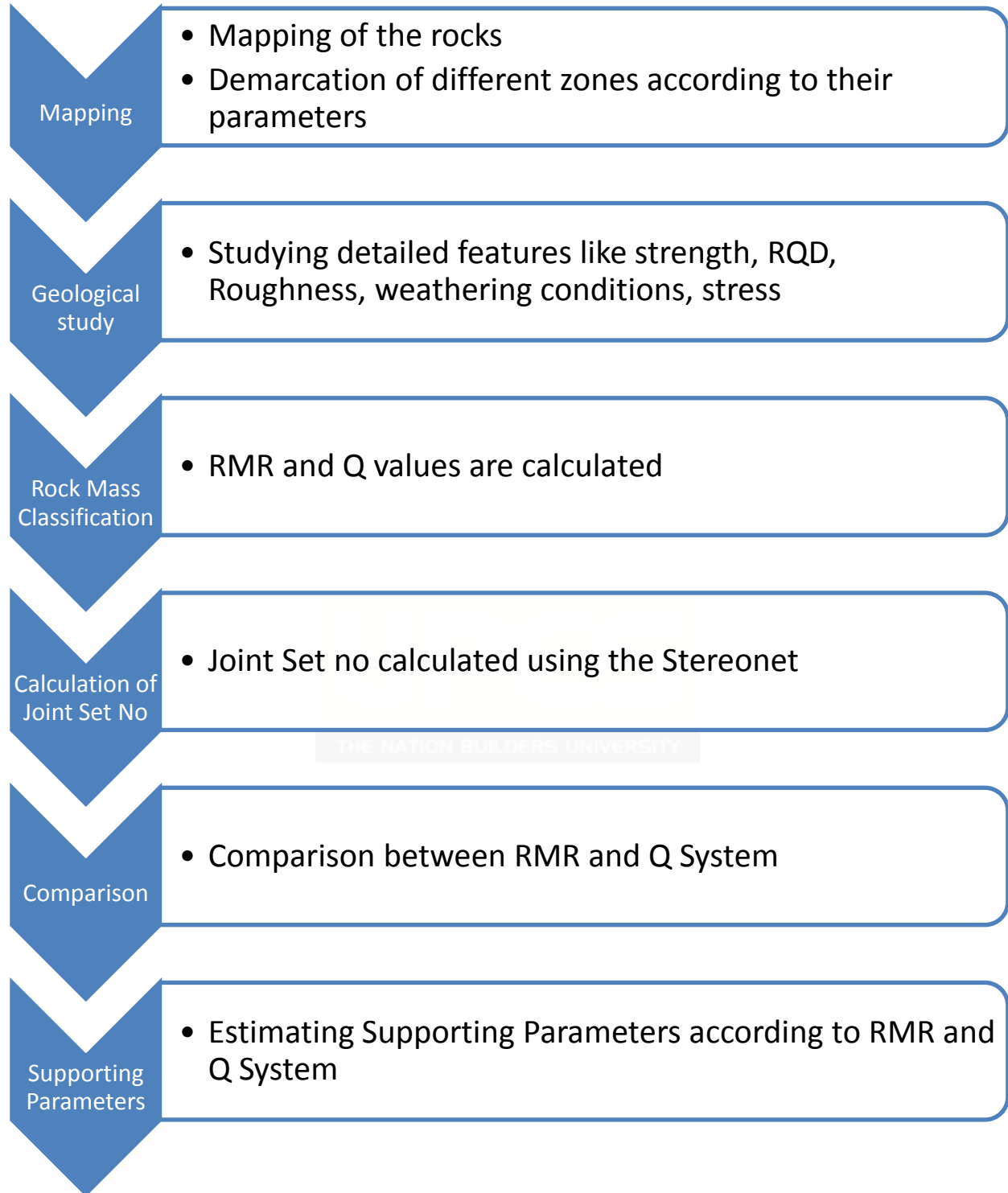

THE NATION BUILDERS UNIVERSITY

CHAPTER-1
INTRODUCTION

Mandakini

Mandakini is a tributary of the Alaknanda River. Mandakini originates from the Chorabari Glacier near Kedarnath in Uttarakhand, India. Mandakini is fed by Vasukiganga River at Sonprayag. Mandakini joins Alaknanda at Rudraprayag. The Mandakini is a runnable low volume river from October to April and can be unpredictable in the Monsoon months (June–September) when all rivers in the area become swollen torrents.

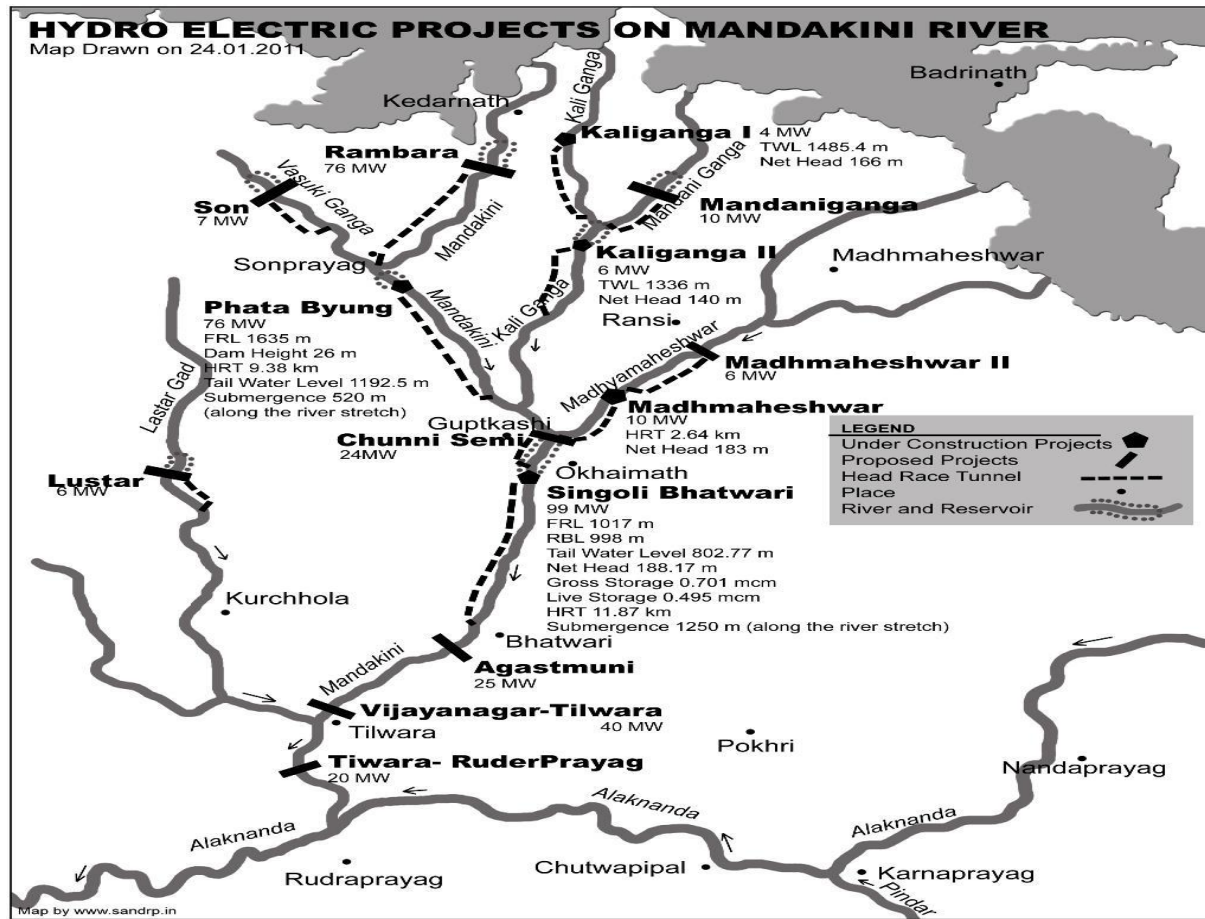

Fig.1- Hydroelectric Projects on River Mandakini

Source: (http://sandrp.in/basin_maps/)

Regional Geology

“Rock Mass Classification and Tunnel Supporting Parameters”

Of the three physiographic divisions of the Himalaya viz. Trans-Himalaya, Lower Himalaya, Higher Himalaya and Trans-Himalaya, the area of Singoli Bhatwari Hydro-Electric Power Project, Mandakini Valley, Uttarakhand falls in the Inner Lower Himalaya. The Mandakini River is a tributary of the Alaknanda River. It originates from a small glacier named Chorabari near Kedarnath in the Great Himalaya and flowing in general towards south, it joins the Alaknanda at Rudraprayag.

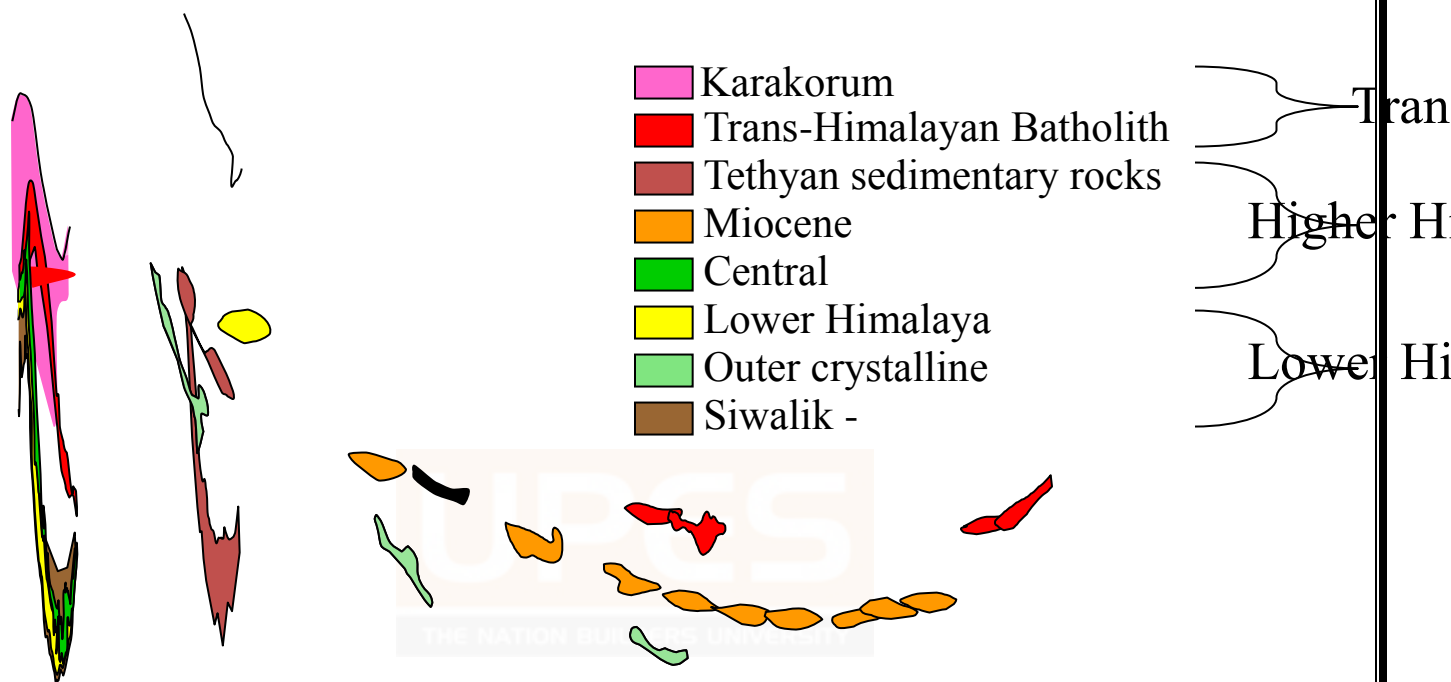

Fig.2-Division of Himalaya

(Source: "Tectonic and metamorphic Evolution of the Central Himalayan Domain in Southeast Zaskar (Kashmir, India)")

Site Geology

- **Geomorphology**

The project area and its surroundings have mountainous topography with medium to high relief. In the area, elevations, m.s.l., range generally between 990 m and 2000 m and relative relief is usually high. The glacial landforms dominate the region and south of Okhimath-Guptakashi area. The area has relatively steeper and rugged hill slopes and narrower valleys as compared to the southern surroundings.

• **Geology of the Area**

Latitude and longitude of the study area is 30°30'17" N, 79°05'22" E and about 250m upstream (u/s) of road bridge at Kund.

The study area is mostly covered with colluviums and fluvio-glacial material. The outcrops are few and sparse generally occur in the road section, river and nala sections.

The rocks exposed in and around the study area belong to Garhwal Group. The Lithological sequence exposed from North to South (i.e study area - kund) is given below:

• **Lithological Sequence**

North

<u>Unit No.</u>	<u>Lithology</u>
1	Schistose quartzite.
2	Calc silicate
3	Chandrapuri granite gneiss with subordinate chlorite schist and amphibolites schist bands Sheared contact.....
4	Quartz-Biotite schist with subordinate amphibolites schist bands.

South

Table2. Lithological Sequence

Description of the rocks is given as under:

1. Schistose quartzite:-It is fine to medium grained gray quartz predominant rock. It is discernible in the field by prominent current bedding which shows normal order of superposition.

2. Cal silicate:-It is a finely granulose aggregate in calc-magnesian-silicates along with calcite and shows solution cavities.

3. Chandrapuri Granite gneiss:-The rock is medium to coarse grained generally gray in colour. The predominant minerals are quartz and felspar. which occur as augens.

4. Quartz Biotite Schist:-It is a quartz predominant rock (74%) with subordinate biotite (15%), plagioclase (about 5%), microperlitute (about 3%) and accessory minerals (about 1%). The felspar grains show cracks at some places indicating strain effect.

5. Amphibolites:-The predominant mineral is hornblende/actinolite 5% to 55%, plagioclase felspar 35% to 40% and accessory minerals 5% to 20%. As the rock shows foliation it is termed as amphibolite schist

6. Mylonite:-This rock occurs at the contact of units 3 and 4 and indicates a sheared contact. The main mineral is quartz (about 50%) which shows shearing and recrystallisation. Next is abundant felspar (about 45%) which forms prophyroblasts and shows alteration and fracture. About 5% of mica is also present.

CHAPTER-2

ROCK MASS CLASSIFICATION

Through the literature survey, information is available on the rock mass and its stress and hydrologic characteristics, the use of a rock mass classification scheme can be of considerable benefit. At its simplest, this may involve using the classification scheme as a check-list to ensure that all relevant information has been considered. At the other end of the spectrum, one or more rock mass classification schemes can be used to build up a picture of the composition and characteristics of a rock mass to provide initial estimates of support requirements, and to provide estimates of the strength and deformation properties of the rock mass.

Geomechanics Classification

The following six parameters are used to classify a rock mass using the *RMR* system:

$$RMR=R1+R2+R3+R4+R5+R6$$

1. Uniaxial compressive strength of rock material (R1)
2. Rock Quality Designation (*RQD*) (R2)
3. Spacing of discontinuities (R3)
4. Condition of discontinuities (R4)
5. Groundwater conditions (R5)
6. Orientation of discontinuities (R6)

In applying this classification system, the rock mass is divided into a number of structural regions and each region is classified separately. The boundaries of the structural regions usually coincide with a major structural feature such as a fault or with a change in rock type. In some cases, significant changes in discontinuity spacing or characteristics, within the same rock type, may necessitate the division of the rock mass into a number of small structural regions.

1. Uniaxial Compressive Strength (UCS)

The strength of the intact rock material should be obtained from rock cores in accordance with site conditions. UCS may also be obtained from the point load strength index tests on rock lumps at the natural moisture content.

Qualitative Description	Compressive Strength(MPa)	Ratings
Exceptionally Strong	>250	15
Very Strong	100-250	12
Strong	50-100	7
Average	25-50	4
Weak	5-25	2
Very Weak	1-5	1
Extremely Weak	<1	0

Table4: Strength of Intact Rock material

2. Rock Quality Designation (RQD)

The Rock Quality Designation index (*RQD*) is used to provide a quantitative estimate of rock mass quality from drill core logs. RQD is defined as the percentage of intact core pieces longer than 100 mm (4 inches) in the total length of core. The core should be at least NW size (54.7 mm or 2.15 inches in diameter) and should be drilled with a double-tube core barrel.

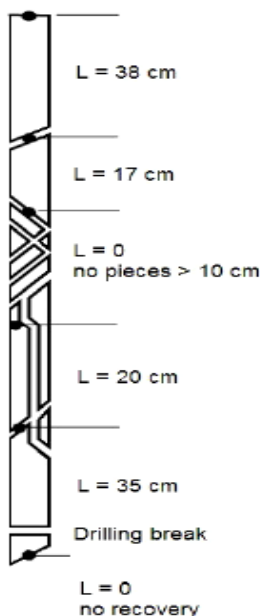

Total length of core run = 200cm

$$RQD = \frac{\text{Sum (Length of core pieces } > 10 \text{ cm length)} * 100}{\text{Total Length of core run}}$$

$$RQD = (38+ 17+20+) * 100/ 200$$

$$RQD = 55\%$$

Fig.3: Procedure for measurement and calculation of RQD

- When no core is available but discontinuity traces are visible in surface exposures or exploration adits, the *RQD* may be estimated from the number of discontinuities per unit volume.

$$RQD = 115 - 3.3 J_v$$

Where J_v is the sum of the number of joints per unit length for all joint (discontinuity) sets.

RQD is a directionally dependent parameter and its value may change significantly, depending upon the borehole orientation. The use of the volumetric joint count can be quite useful in reducing this directional dependence.

Quantitative Description	RQD	Rating
Excellent	90-100	20
Good	75-90	17
Fair	50-75	13
Poor	25-50	8
Very Poor	<25	3

Table5: Rock Quality Designation (RQD)

3. Spacing of Discontinuities

The term discontinuity covers joints, beddings or foliations, shear zones, minor faults or other surfaces of weakness. The linear distance between two adjacent discontinuities should be measured for all sets of discontinuities.

Description	Spacing(m)	Rating
Very wide	>2	20
Wide	0.6-2	15
Moderate	0.2-0.6	10
Close	0.06-0.2	8
Very close	<0.06	5

Table6: Spacing of Discontinuities

4. Condition of Discontinuities

This parameter includes roughness of discontinuity surface, their separation, length or continuity, weathering of the wall rock or the plane of weakness and infilling (gouge) material.

Description	Joint Separation(mm)	Rating
Very rough and unweathered, wall rock tight and discontinuous, no separation	0	30
Rough and slightly weathered, wall rock surface separation <1mm	<1	25
Slightly rough and moderately to highly weathered, wall rock surface separation < 1mm	<1	20
Slicken sided wall rock surface or 1-5mm thick gouge or 1-5mm wide continuous discontinuity	1-5	10
5mm thickness soft gouge, 5mm wide continuous discontinuity	>5	0

Table7: Condition of Discontinuities

5. Groundwater Condition

The rate of inflow of ground water in liter per minute per 10m length of the tunnel should be determined or a general condition may be described as completely dry, damp, wet, dripping and flowing.

Inflow per 10m Tunnel length (liter/min)	Ratio of joint water pressure to major principle stress	General description	Rating
None	0	Completely Dry	15
<10	0-0.1	Damp	10
10-25	0.1-0.2	Wet	7
25-125	0.2-0.5	Dripping	4
>125	>0.5	Flowing	0

Table8: Groundwater Conditions

6. Orientation of Discontinuities

Orientation of discontinuities means the strike and dip of discontinuities. The strike should be recorded with reference to magnetic north. The dip angle is the angle between the horizontal and the discontinuity plane taken in a direction in which the plane dips. The influence of the strike and the dip of the discontinuities are considered with respect to the direction of tunnel drivage or slope face orientation or foundation alignment.

Strike perpendicular to Tunnel axis		Strike parallel to Tunnel axis	
Drive with dip – Dip 45-90(deg)	Drive with dip – Dip 20-45(deg)	Dip 45-90 (deg)	Dip 20-45 (deg)
Very favorable	Favorable	Very Favorable	Fair
Drive against dip – Dip 45-90(deg)	Drive against dip – Dip 20-45(deg)	Dip 0-20 (deg) Irrespective of Strike	
Fair	Unfavorable	Fair	

Table9: Effect of Discontinuity Strike and Dip Orientation in Tunneling

Strike and Dip Orientation		Very Favorable	Favorable	Fair	Unfavorable	Very Unfavorable
	Tunnels & mines	0	-2	-5	-10	-12
Ratings	Foundation	0	-2	-7	-15	-25
	Slopes	0	-5	-25	-50	

Table10: Rating adjustment for Discontinuity Orientation

The Rock mass Parameters are obtained from the above mentioned six parameters. It helps us to identify the class of Rock mass.

Description	Class number	Rating
Very good rock	1	81-100
Good rock	2	61-80
Fair rock	3	41-60
Poor rock	4	21-40
Very poor rock	5	<21

Table11: Rock Mass Classes Determined from the total Ratings

Rock Tunneling Quality Index, *Q* or Q- System

The goal of Q- System is preliminary Imperial design of support system for Tunnels and caverns. It is the best among all the classification system for the support in tunnels. The numerical value of the index *Q* varies on a logarithmic scale from 0.001 to a maximum of 1,000 and is defined by:

$$Q = RQD / J_n \times J_r / J_a \times J_w / SRF$$

Where:-

RQD is the Rock Quality Designation

J_n is the joint set number

J_r is the joint roughness number

J_a is the joint alteration number

J_w is the joint water reduction factor

SRF is the stress reduction factor

1. Rock Quality Designation (RQD)

The RQD value in percentage is also the rating of RQD for the Q-system. In case the rock cores are not available, the RQD may be estimated by the volumetric joint count (*J_v*) The *J_v* is sum of frequencies of all joint sets per meter in a pit of 1m × 1m × 1m.

Condition	RQD
Excellent	90-100
Good	75-90
Fair	50-75
Poor	25-50
Very Poor	0-25

Table12: Rock Quality Designation (RQD)

2. Joint set number (J_n)

The parameter J_n , representing the number of joint sets, is often affected by foliations, schistosity, slaty cleavages or beddings, etc. If strongly developed, these parallel discontinuities should be counted as a complete joint set. If there are few joints visible or only occasional breaks in rock core due to these features, then one should count them as “a random joint set”. Rating of J_n is approximately equal to square of the number of joint sets.

Condition	J_n
Massive, no or few joint set	0.5-1
One joint set	2
One joint set plus random	3
Two joint set	4
Two joint set plus random	6
Three joint sets	9
Three joint sets plus random	12
Four or more Joint set, heavily jointed	15
Crushed Rock	20

Table13: Joint set number

3. Joint roughness number and joint alteration number (J_r and J_a)

The parameters J_r and J_a , represent roughness and degree of alteration of joint walls or filling materials. The parameters J_r and J_a should be obtained for the weakest critical joint set or clay-filled discontinuity in a given zone. If the joint set or the discontinuity with the minimum value of (J_r / J_a) is favorably oriented

for stability, then a second less favorably oriented joint set or discontinuity may be of greater significance, and its value of (J_r / J_a) should be used when evaluating Q .

Condition	J_r
Discontinuous Joints	4
Rough or irregular, undulating	3
Smooth, Undulating	2
Slickensided, Undulating	1.5
Rough or irregular, planar	1.5
Smooth, Planar	1
Slickensided, Planar	0.5

Table14: Joint Roughness Number

Condition	Ja
No mineral filling only Coating	
Tightly healed hard, impermeable filling	0.75
Unaltered Joint wall	1
Slightly altered Joint wall, non-softening material coating	2
Silty or sandy clay coating	3
Softening or low friction clay mineral coating	4
Thin mineral filling	
Sandy particles, clay-free disintegrated rock	4
Strongly over-consolidated, non-softening clay mineral filling (continuous, <5mm thickness)	6
Low over-consolidated, softening clay mineral filling (continuous, <5mm thickness)	8
Swelling clay filling	8-12

Table15: Joint Alteration number

4. Joint water reduction factor (J_w)

The parameter J_w is a measure of water pressure, which has an adverse effect on the shear strength of joints. This is due to reduction in the effective normal stress across joints. Water in addition may cause softening and possible wash-out in the case of clay-filled joints. The value of J_w should correspond to the future ground water condition where seepage erosion or leaching of chemical can alter permeability of rock mass significantly.

Condition	J_w
Dry excavation or minor inflow	1
Medium inflow or pressure, occasional outwash of joint fillings	0.66
Large inflow or high pressure in competent rock with unfilled joints	0.5
Large inflow or high pressure, considerable outwash of rock filling	0.33
Exceptionally high inflow or water pressure at blasting	0.2-0.1
Exceptionally high inflow or water pressure continuing without noticeable decay	0.1-0.05

Table16: Joint water reduction factor

5. Stress reduction factor (SRF)

The parameter SRF is a measure of (i) loosening pressure in the case of an excavation through shear zones and clay bearing rock masses, (ii) rock stress (UCS/major principal stress) in a competent rock mass and (iii) squeezing or swelling pressures in incompetent rock masses.

Condition	SRF
Multiple occurrence of weakness zones containing clay or very loose surrounding rock (any depth)	10
Single weakness zone containing clay or rock(depth of excavation $\leq 50\text{m}$)	5
Single weakness zone containing clay or rock(depth of excavation $> 50\text{m}$)	2.5
Multiple shear zoning competent rock(clay free), loose surrounding rock (any depth)	7.5
Single shear zone in competent rock (depth of excavation $\leq 50\text{m}$)	5
Single shear zone in competent rock (depth of excavation $>50\text{m}$)	2.5
Loose, open joint, heavily jointed(any depth)	5
Low stress near surface open joints	2.5.
Medium stress, favourable joint condition	1
High stress, very tight structure	0.5-2
Moderately slabbing	5-50
Slabbing and rock burst after few minutes in massive rocks	50-200
Heavy rockburst and immediate deformation in massive rock	200-400

Table 17: Stress reduction factor (SRF)

CHAPTER 3

TUNNEL SUPPORTING PARAMETERS

Rock bolts

Rock bolts generally consist of plain steel rods with a mechanical or chemical anchor at one end and a face plate and nut at the other. They are always tensioned after installation. For permanent applications or in rock in which corrosive groundwater is present, the space between the bolt and the rock can be filled with cement or resin grout. The length of Rock bolts depends upon the orientation of joints and dimensions of Wedge failure.

Different types of Rock bolts are:

- **Mechanically anchored rock bolts**
- **Resin anchored rock bolts**

Resin anchored rock bolts

The Resin Anchored Rock Bolts are used where it is essential to maintain support load. Tension will occur in a Rock bolt when nut is screwed to the rock surface and will act as a one block with the surrounding rocks.

Rock bolt used in our Project:

Length of Rock bolt used is : 2.5m

Diameter of Rock bolt used is : 30mm

Procedure for insertion of Rock bolt:

- ❖ 3m length is drilled having a diameter of 30mm by boomer.
- ❖ A Resin Capsule of length 0.9m is inserted into a drilled portion. The length is divided into 3 parts having dimensions of 30cm.
- ❖ A cement capsule is then inserted into a remaining portion.
- ❖ A rock bolt is then inserted into drilled hole. Resin and Cement Capsules are used to provide strength to Rock bolts.
- ❖ A steel plate is then screwed into the outer portion of the Rock bolt.
Note: But incase nut is screwed in a greater extent it would result in failure and causes sudden downfall of Rock bolt.
- ❖ Geologists tells about the orientation and type of bolts to be used at a particular place.
- ❖ Quality test is done to check the quality of Rock bolt.

Primary causes of Rock bolts failure is rusting or corrosion and this can be counteracted by filling the gap between the bolt and the drillhole wall with grout.

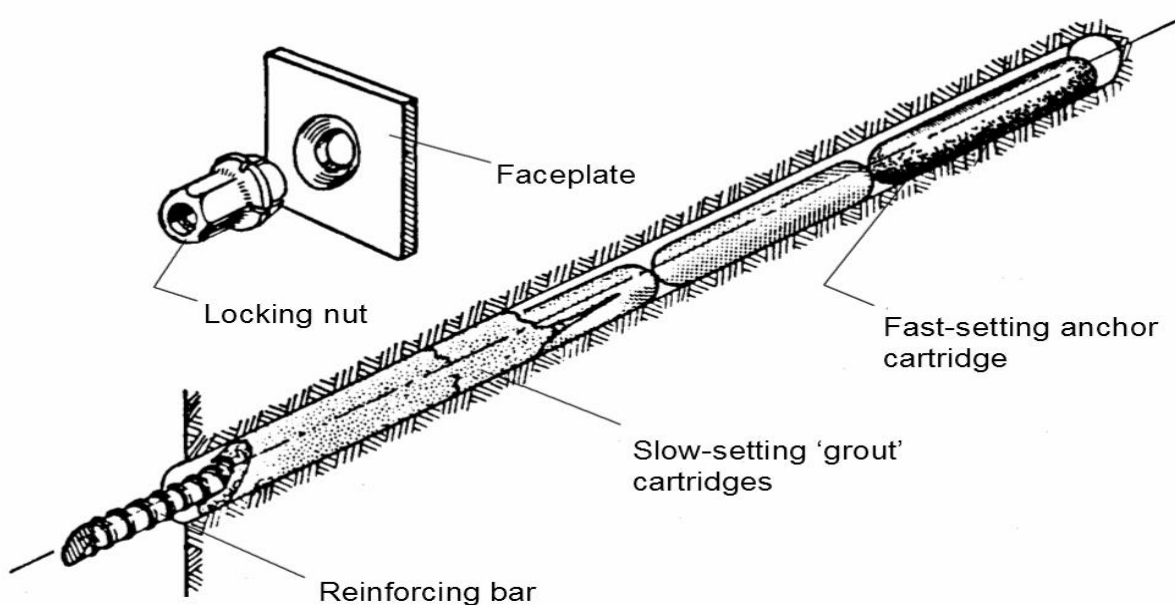

Fig.4: Typical set-up for creating a resin anchored and grouted rock bolt
(Source: Engineering Hook)

Shotcrete support

An important area of shotcrete application in underground mining is in the support of 'permanent' openings such as ramps, haulages, shaft stations and crusher chambers. Rehabilitation of conventional rock bolt and mesh support can be very disruptive and expensive. Increasing numbers of these excavations are being shotcrete immediately after excavation.

Different types of Shotcrete are:

- **Dry mix shotcrete**
- **Wet mix shotcrete**
- **Steel fibre reinforced micro silica shotcrete**
- **Mesh reinforced shotcrete**

Steel fibre reinforced micro silica shotcrete

Of the many developments in shotcrete technology in recent years, two of the most significant were the introduction of silica fume, used as a cementitious admixture, and steel or polypropylene fibre reinforcement.

Silica fume or micro silica is a by-product of the ferro silicon metal industry and is an extremely fine pozzolan. Pozzolans are cementitious materials which react with the calcium hydroxide produced during cement hydration. Silica fume, added in quantities of 8 to 13% by

weight of cement, can allow shotcrete to achieve compressive strengths which are double or triple the value of plain shotcrete mixes.

The result is an extremely strong, impermeable and durable shotcrete. Other benefits include reduced rebound, improved flexural strength, improved bond with the rock mass and the ability to place layers of up to 200 mm thick in a single pass because of the shotcrete ‘stickiness’.

Mesh reinforced shotcrete

While steel fibre reinforced shotcrete has been widely accepted in both civil and mining engineering, mesh reinforced shotcrete is still widely used and is preferred in some applications. In very poor quality, loose rock masses, the mesh provides a significant amount of reinforcement, even without shotcrete. When stabilizing slopes in very poor quality rock masses or when building bulkheads for underground fill, weld mesh is frequently used to stabilize the surface or to provide reinforcement. In such cases, plain shotcrete is applied later to provide additional support and to protect the mesh against corrosion.

The mesh reinforced samples were superior in bending with both point loads and uniformly distributed loads.

Chainlink mesh, used in many underground mining excavations to support loose rock, is not usually suitable for shotcrete reinforcement. This is because penetration of the shotcrete is inhibited by the twisted joints. This allows air cavities to form behind the mesh and these may allow water to enter and cause corrosion of the mesh. Typically the weldmesh should be made from 4 mm diameter wire welded into a 100 mm x 100 mm grid. This type of mesh is strong enough for most underground applications.



Figure.5: Shortcrete



Figure.6: Welded wire mesh

(Source: Google image)

Grouting

It is used to seal joints or cavities by pumping grout. Grouting technique is used for soil improvement. It is used to achieve a stronger, denser and less permeable soil or rock.

Grout is a mixture of water, Cement and sand. Different types of Grout are:

- Non- Shrink Grout: It is used between metal bearing plate and substrate (rock).
- Tiling Grout: It is used to fill space between tiles.

Steel Rib

It is used when rocks are in poor condition. It is used to provide vertical support to tunnel. Lagging is a concrete placed between the Steel Ribs.



Figure.7: Steel Support System

Source- Jacob association

“Rock Mass Classification and Tunnel Supporting Parameters”

Rock Mass Class	Excavation	Rock bolts(20mm diameter, fully grouted)	Shotcrete	Steel Sets
Very Good Rock RMR: 81-100	Full Face, 3m advance	Generally no support required accepts Spot bolting		
Good Rock RMR:61-80	Full Face, 1-1.5m advance	Locally, Bolts in crown 3m long, spaced 2.5m with occasional wire mesh	50mm in crown where required	None
Fair Rock RMR:41-60	Top heading and bench 1.5-3m advance in top heading	Systematic bolts 4m long, spaced 1.5-2m in crown and wall with wire mesh in crown	50-100m in crown and 30mm in side	None
Poor Rock RMR:21-40	Top heading and bench 1-1.5m advance in top heading	Systematic bolts 4-4.5m long, spaced 1-1.5m in crown and wall with wire mesh	100-150m in crown and 100mm in side	Light to medium ribs spaced 1.5m where required
Very Poor Rock RMR:<20	Multiple drifts 0.5-1.5m advance in top heading	Systematic bolts 5-6m long, spaced 1-1.5m in crown and wall with wire mesh bolt invert	150-200m in crown and 150mm in side and 50mm in face	Medium to heavy ribs spaced 0.75m with steel laggings and fore poling if required close invert

Table 18: Guidelines for excavation and support of 10m span in rock tunnels

CHAPTER 4

FIELD WORK

CHAPTER 2: GEOLOGICAL FIELD WORK EQUIPMENTS

For purpose of geological field-work, an engineer must provide himself with the following equipment:

- a) A geologist’s hammer
- b) A haversack
- c) A few satchels
- d) A clinometers – compass
- e) A filed note- book.

If available, geological map of the region or, at least, an accurate topographical map should be procured.

Geologist’s hammer

A geologist’s hammer differ’s radically from those used by blacksmiths, carpenters and other technicians. Geological hammers have one chisel end and another flat end and are generally provided with wooden handles. The flat end is commonly used in breaking rocks while the chisel end is used for trimming and sizing of the specimens. Hammers of better quality are generally made up of tough steel. Depending on the work, hammers of suitable size and weight should be chosen. Common geological hammers weigh about one kilogram.



Haversack and Satchels

The haversack is used for carrying the specimens collected in the field . Satchels are bags, made up of cloth or paper in which the individual specimens are placed along with their labels. The number of satchels to be taken depends on the number of specimens likely to be collected during the work.

Geological compass

A compass works by detecting the Earth's natural magnetic fields. The Earth has an iron core that is part liquid and part solid crystal due to gravitational pressure. It is believed that movement in the liquid outer core is what produces the Earth's magnetic field. Like all magnetic fields the Earth's magnetic field has two main poles, a north and south pole. These magnetic poles are slightly off from the Earth's axis rotation which is used as the basis of the geographic poles, but they are close enough that the general directions with adjustments for the polar difference, called a declination, can be used for navigation.

Essentially a compass is a light weight magnet, generally a magnetized needle, on a free rotating pivot. This allows the needle to better react to nearby magnetic fields. Since opposites attract the southern pole of the needle is attracted to the Earth's natural magnetic north pole. This is how navigators are able to discern north.

There are a number of different (specialised) magnetic compasses used by geologists to measure orientation of geological structures, as they map in the field, to analyse (and document) the geometry of bedding planes, joints, and/or metamorphic foliations and lineations. In this aspect the most common device used to date its the analogue compass.

A functional field compass for geological field work should have the following attributes:

- Must be lightweight and portable - can be carried on a belt loop or neck lanyard.
- The compass should be able to provide a precession of 1 degree for bearings.
- The compass should have magnetic declination adjustment mechanism.
- The compass should have a clinometer to allow the measurement of slopes and structural information such as dip and plunge.

Two major types of compasses are current in use by the geologic community for geologic field work:

a) **The Brunton Compass or Pocket Transit compass**:- The bearing scale fixed to the outside body of the compass; with this type of geometry the E and W bearing marks appear to be "backward." Most geologists in North America use the old surveying "quadrant-type" (90 degree) version on the compass.

b) **orienting-type" compasses** :-It can be used for geological field work. This type of compass is less versatile in measuring versatile angles, and is less precise in bearing measurements. These compasses sell for approximately 1/3 the cost of a Brunton-type compass and are lightweight and rugged. Most compasses of this type have a liquid-filled body, which allows for rapid bearing measurements.

c) **Other type of compass** :-

- Silva compass
- Freiberg compass
- Clark compass
- Digital compass

“Rock Mass Classification and Tunnel Supporting Parameters”



STEREONET

Stereonet is a tool used by geologists to visualize three dimensional data in two dimensions. They can be employed for a variety of analytical purposes as well. The essence of this type of projection is that it preserves areas at the expense of angles and shapes. Angles and shapes are especially distorted near the poles.

A line is represented as a point on the stereogram
A horizontal line will project as a point on the equatorial plane

Stereonet is used in :

- Engineering
- Fracture analyses used in hydrogeology and/or groundwater pollution potentials
- Landslide hazard/slope failure studies

Stereonet is typically used in tunnels to determine the relative position of beds, joint sets and planes. This allows to visualize the relation between the various joint sets and planes which would help in efficient planning of support in the tunnel. Wedge determination can be used to determine if there is possibility of any wedge formation and provide timely support to the structure to prevent any failure.

The below Stereonet describes a 3 dominant Joint sets on a Vertical wall rock near the Intake area :

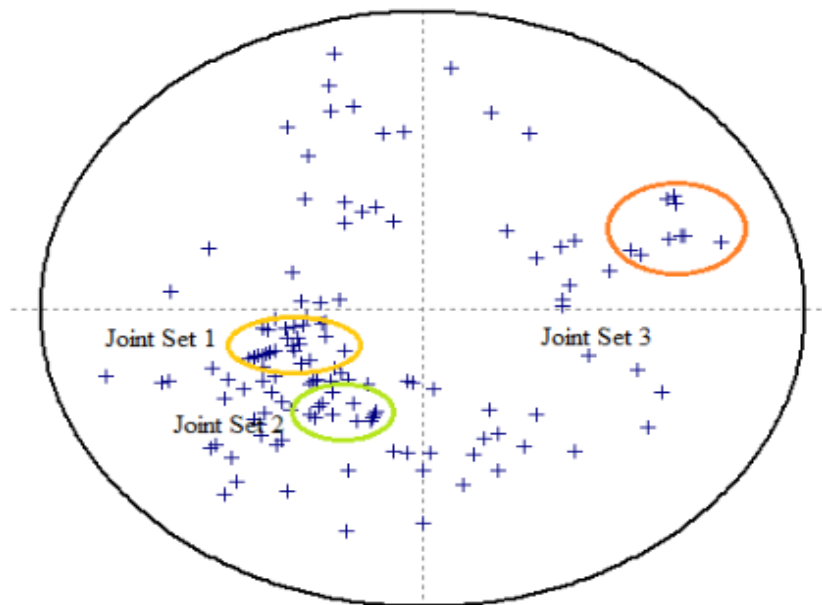

Fig.8: Joint set Identification

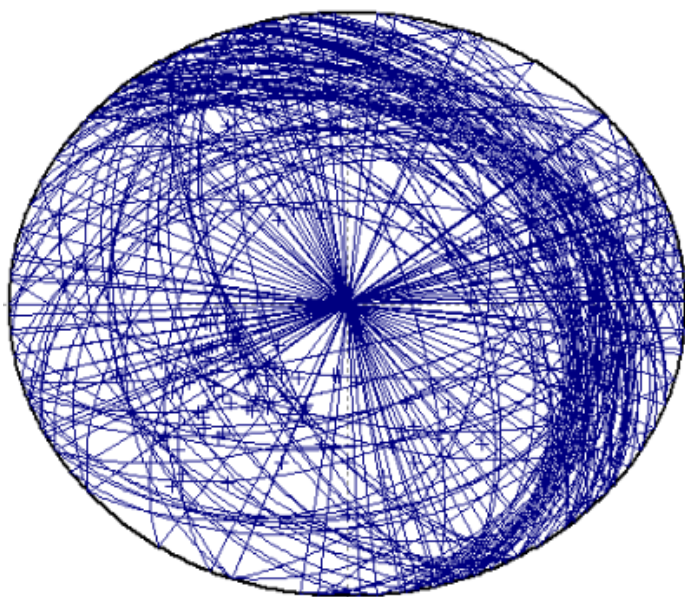

Fig.9: Stereonet showing Dip Direction

“Rock Mass Classification and Tunnel Supporting Parameters”

S.No	Strike/dip amount/dip direction	S.No	Strike/dip amount/dip direction
1	090/45/360/	76	340/62/70
2	060/44/330	77	265/50/175
3	350/28/080	78	330/50/060
4	065/31/333	79	150/65/040
5	055/29/145	80	115/54/205
6	005/22/095	81	340/60/070
7	170/35/081	82	310/50/040
8	350/21/080	83	310/48/040
9	340/22/070	84	330/50/060
10	075/60/165	85	200/50/290
11	070/30/160	86	185/56/95
12	170/30/080	87	295/34/025
13	035/26/080	88	315/25/045
14	310/35/040	89	060/34/150
15	330/70/060	90	320/40/050
16	075/25/165	91	330/64/242
17	080/50/170	92	330/30/060
18	340/49/070	93	320/40/050
19	160/40/070	94	340/62/250
20	320/45/050	95	320/48/050
21	318/48/048	96	328/20/056
22	200/30/110	97	164/70/254
23	263/40/353	98	064/30/154
24	308/38/038	99	165/30/075
25	320/40/50	100	344/28/074
26	240/60/150	101	130/25/040
27	060/50/150	102	140/25/050
28	290/34/020	103	124/35/034
29	266/22/354	104	310/30/040
30	316/40/046	105	310/34/040
31	250/38/340	106	320/40/050
32	340/39/070	107	320/32/050
33	262/40/009	108	140/60/050
34	230/52/320	109	330/34/240
35	245/38/335	110	340/50/252

“Rock Mass Classification and Tunnel Supporting Parameters”

36	160/61/250	111	280/20/010
37	340/28/070	112	300/30/030
38	165/42/255	113	285/58/195
39	350/32/085	114	315/28/045
40	330/28/240	115	340/38/070
41	162/30/268	116	335/38/065
42	152/32/258	117	214/60/304
43	340/30/070	118	340/58/250
44	330/28/220	119	024/58/294
45	255/78/165	120	340/48/250
46	260/50/350	121	310/25/040
47	320/62/050	122	320/30/050
48	335/30/265	123	330/28/060
49	230/45/340	124	338/30/068
50	320/48/050	125	300/24/030
51	275/40/005	126	310/35/040
52	290/37/070	127	310/38/040
53	250/60/160	128	290/48/020
54	290/48/020	129	200/50/110
55	290/32/20	130	130/31/050
56	084/20/006	131	330/40/060
57	330/38/240	132	330/65/240
58	040/40/140	133	275/70/185
59	255/42/345	134	328/20/56
60	290/33/020	135	165/75/075
61	285/66/015	136	320/25/050
62	270/61/360	137	315/50/045
63	150/63/240	138	345/30/075
64	150/40/060	139	020/38/290
65	155/47/065	140	330/45/060
66	150/37/060	141	335/40/055
67	072/68/162	142	050/38/320
68	160/36/070	143	310/25/040
69	150/30/060	144	300/60/030
70	350/22/080	145	310/70/040

“Rock Mass Classification and Tunnel Supporting Parameters”

71	140/40/050	146	290/30/020
72	340/34/070	147	315/60/045
73	355/25/085	148	320/48/050
74	350/34/080	149	020/38/290
75	160/35/070	150	330/55/240

Fig 19: Values of Strike & Dip direction and Dip amount.

CHAPTER 5 OBSERVATIONS

Facelog 1
RMR and Q calculation
Tunnel Drive : 195 Degree (N15E & S15W)

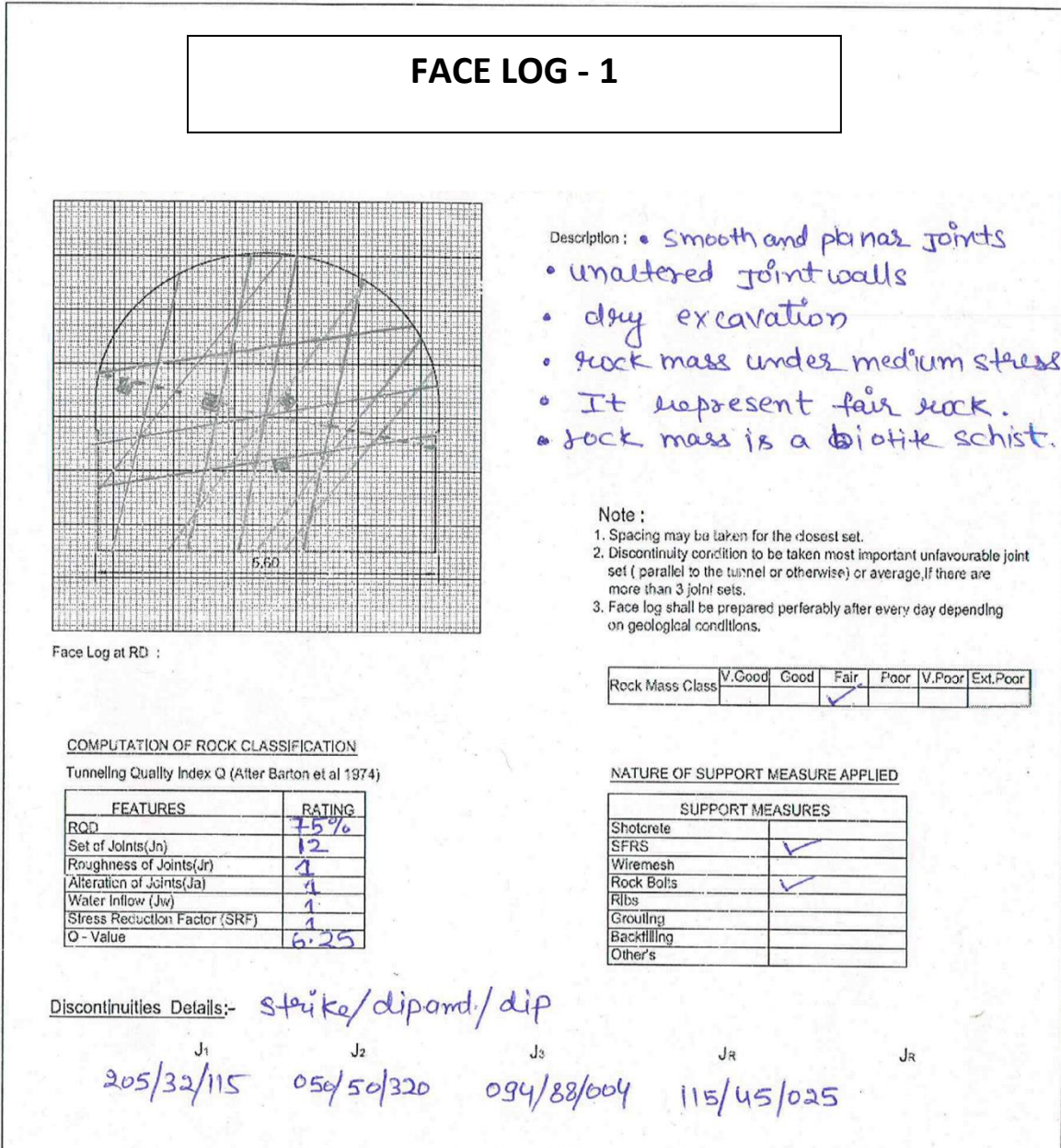
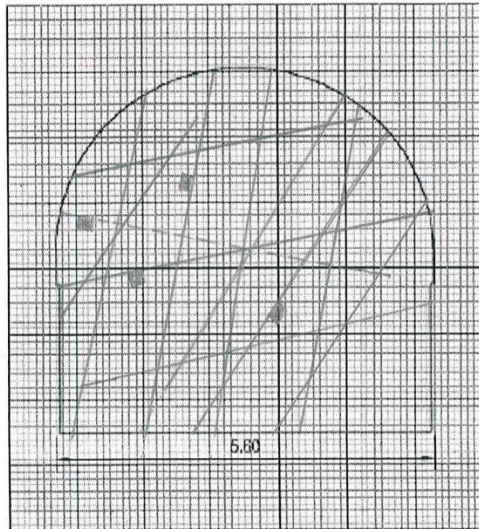

Figure.10 : Facelog 1 showing Q computation

"Rock Mass Classification and Tunnel Supporting Parameters"



- Description:-
- slickensided surface of joints.
 - groundwater condition is dry to damp
 - spacing of joint is approx 30cm.
 - strike of joint set 1 is approx. parallel to tunnel axis & its dip angle is 32° which shows fair condition for orientation of joints.
 - It represent fair rock.

Rock Mass Class	V.Good	Good	Fair	Poor	V.Poor	Ext.Poor
			✓			

NATURE OF SUPPORT MEASURE APPLIED

SUPPORT MEASURES	
Shotcrete	
SFRS	✓
Wiremesh	
Rock Bolts	✓
Ribs	
Grouting	
Backfilling	
Other's	

Computation of Rock Classification (RMR)	
Features	Rating
UCS	12
RQD	13
Spacing of Discontinuities	10
Condition of discontinuities	10
Groundwater Conditions	10
Orientation of Discontinuities	-5
RMR	50

Discontinuities Details: strike/dip and/ dip

J_1 205/32/115
 J_2 050/50/320
 J_3 094/88/004
 J_4 115/45/025

Figure.11 : Facelog 1 showing RMR computation

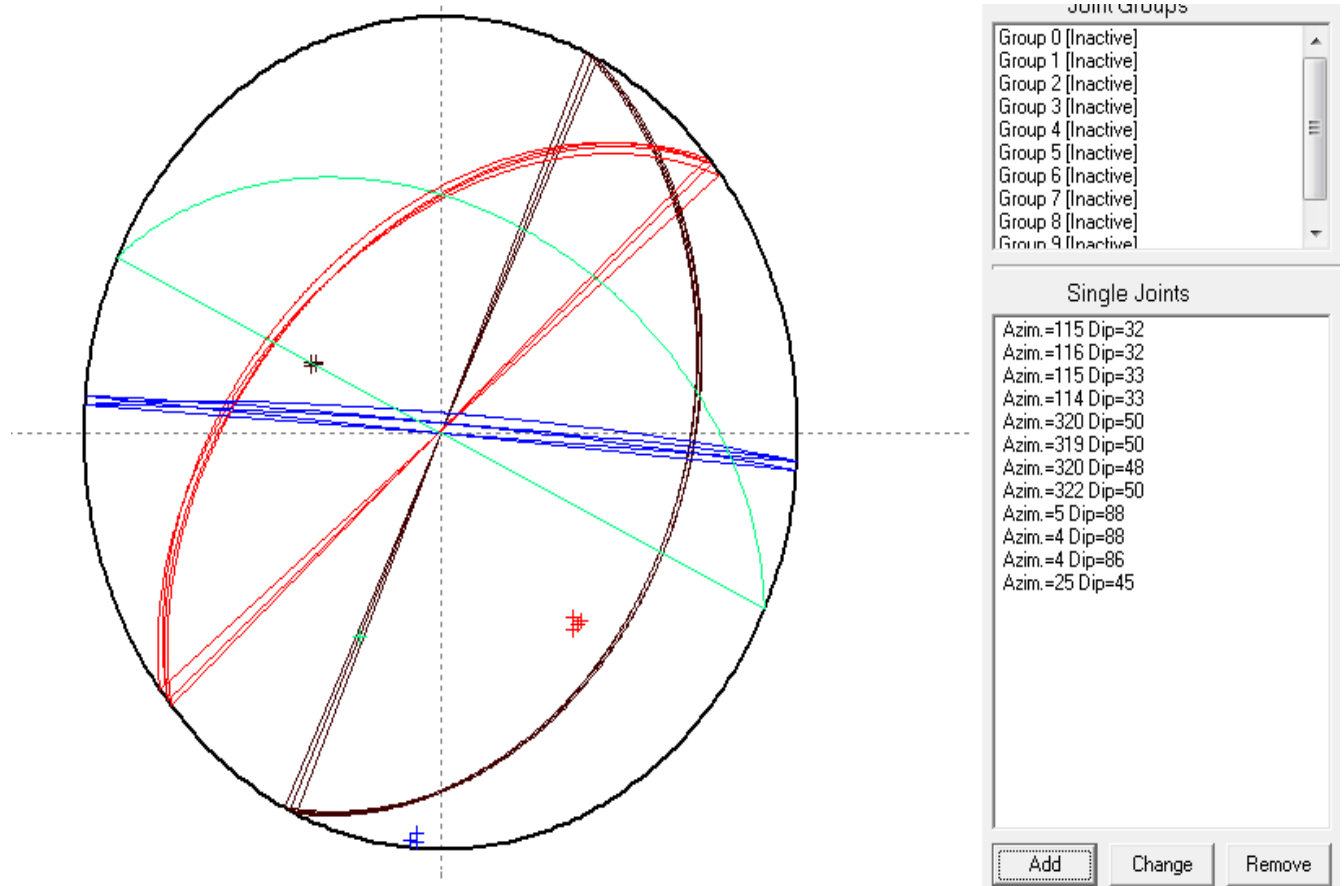

Figure.12 : Stereonet of Facelog 1

Calculation of RQD

$$RQD = 115 - 3.3J_v \quad (J_v = 12)$$

$$RQD = (115 - 3.3 \times 12)$$

$$RQD = 75\%$$

Support Recommendation

Rock bolts and Shotcrete are required to support the excavated span.

Length of Rock bolts = 2.5m and SFRS (Steel Fibre Reinforced Shotcrete) are required to be used.

"Rock Mass Classification and Tunnel Supporting Parameters"

Facelog 2

RMR and Q calculation

Tunnel Drive : 195 Degree (N15E & S15W)

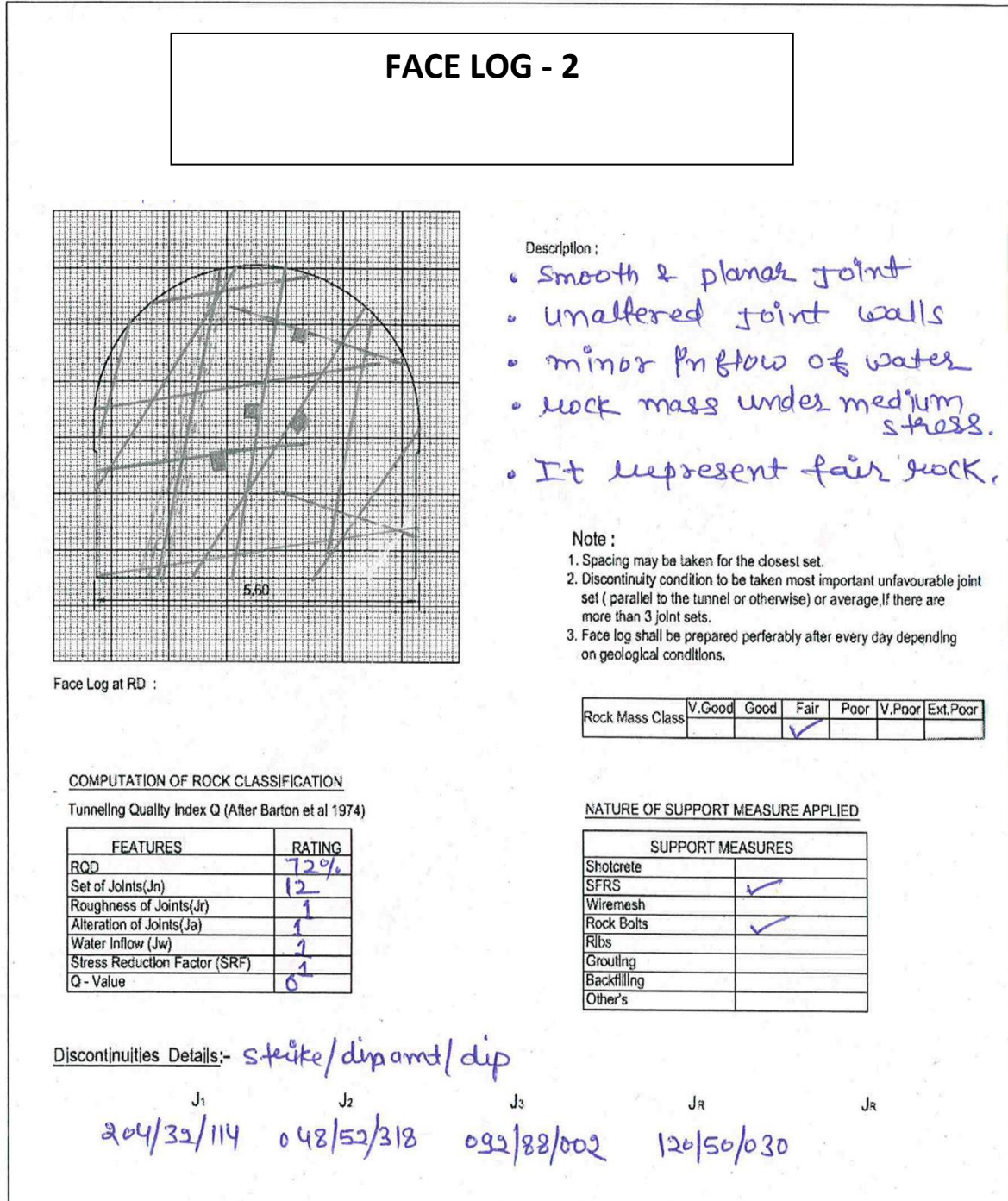
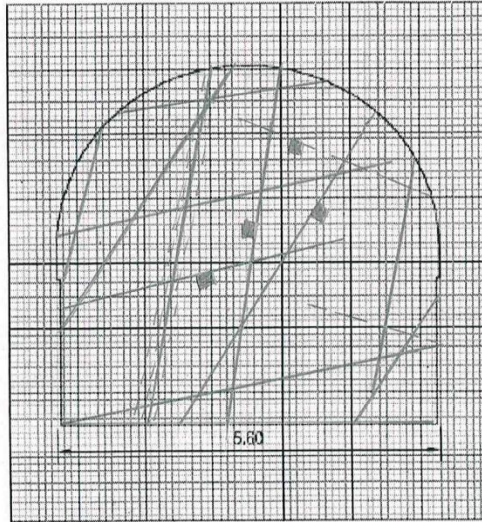

Figure.13 : Facelog 2 showing Q computation

"Rock Mass Classification and Tunnel Supporting Parameters"



- Description: →
- ground water condition is damp to wet.
 - spacing of joint is approx 18 cm.
 - slicken sided surface of joints
 - strike of joints set 1 is approx parallel to tunnel axis & its dip amt is 32 which show fair condition for orientation of joints.
 - It represent fair rock.

Rock Mass Class	V.Good	Good	Fair	Poor	V.Poor	Ext.Poor
			✓			

NATURE OF SUPPORT MEASURE APPLIED

SUPPORT MEASURES	
Shotcrete	
SFRS	✓
Wiremesh	
Rock Bolts	✓
Ribs	
Grouting	
Backfilling	
Other's	

Computation of Rock Classification (RMR)	
Features	Rating
UCS	12
RQD	13
Spacing of Discontinuities	8
Condition of discontinuities	10
Groundwater Conditions	7
Orientation of Discontinuities	-5
RMR	45

Discontinuities Details: strike / dip amt / dip

J ₁	J ₂	J ₃	J _e
204/32/114	048/52/318	092/88/002	120/50/030

Figure.14 : Facelog 2 showing RMR computation

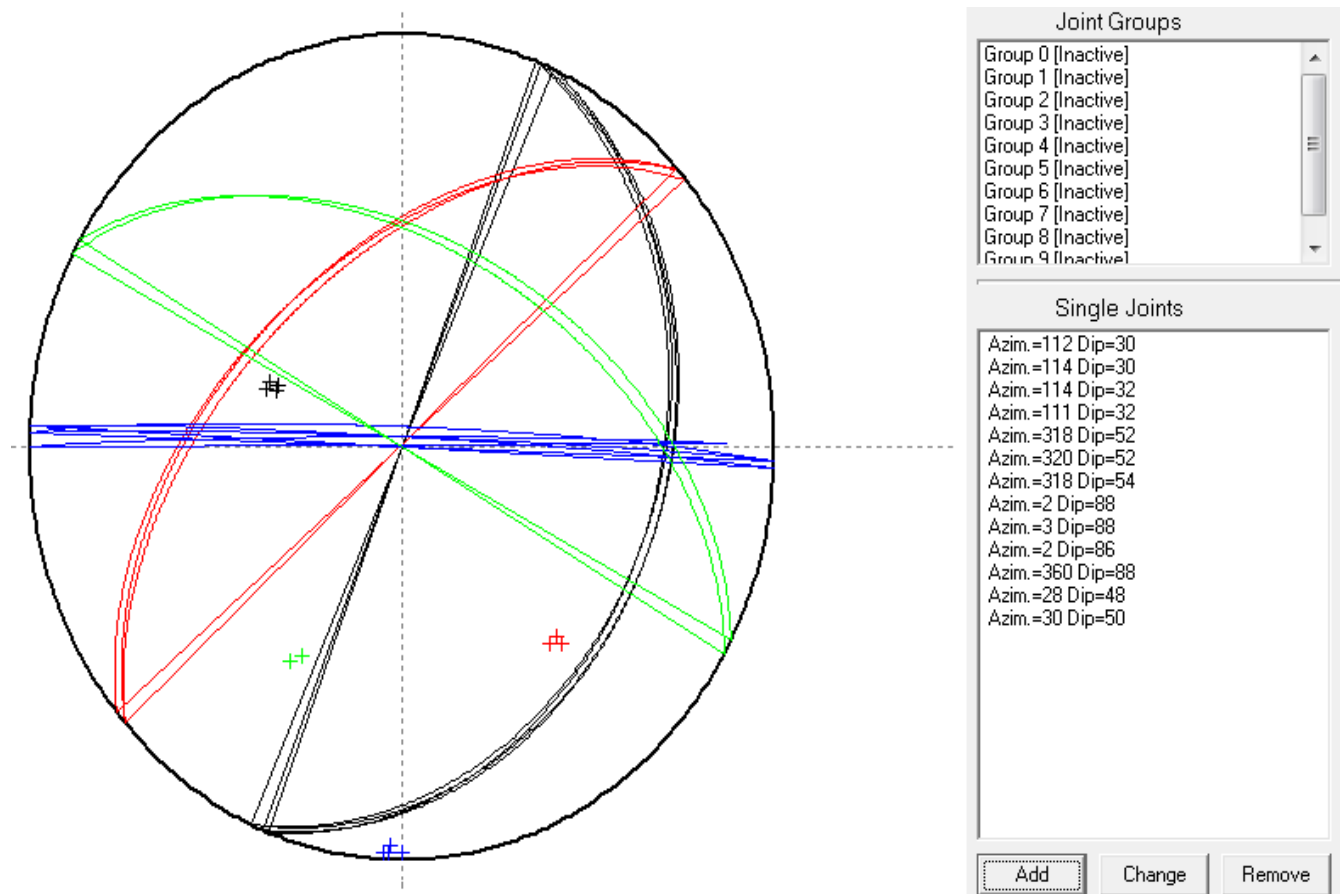

Figure.15 ; Stereonet of Facelog 2

Calculation of RQD

$$RQD = 115 - 3.3J_v \quad (J_v = 13)$$

$$RQD = (115 - 3.3 \times 13)$$

$$RQD = 72\%$$

Support Recommendation

Rock bolts and Shotcrete are required to support the excavated span.

Length of Rock bolts = 2.5m and SFRS (Steel Fibre Reinforced Shotcrete) are required to be used.

Facelog 3

RMR and Q calculation

Tunnel Drive : 195 Degree (N15E & S15W)

FACELOG - 3

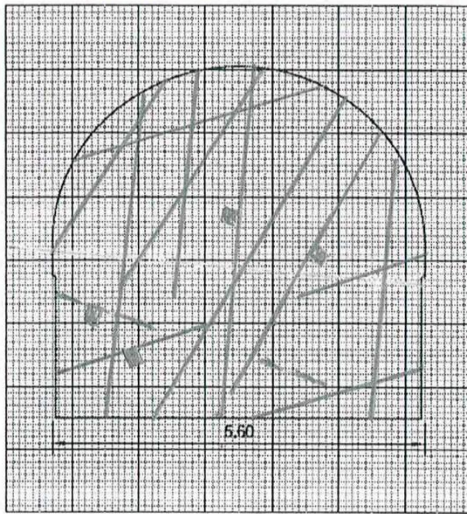

Description :

- The joint walls are unaltered and represent smooth and planar surface.
- ground water condition are almost dry.
- rock mass is under medium stress.
- It represent fair rock.

Note :

1. Spacing may be taken for the closest set.
2. Discontinuity condition to be taken most important unfavourable joint set (parallel to the tunnel or otherwise) or average, if there are more than 3 joint sets.
3. Face log shall be prepared preferably after every day depending on geological conditions.

Face Log at RD :

Rock Mass Class	V.Good	Good	Fair	Poor	V.Poor	Ext.Poor
			✓			

COMPUTATION OF ROCK CLASSIFICATION

Tunneling Quality Index Q (After Barton et al 1974)

FEATURES	RATING
RQD	75%
Set of Joints(Jn)	12
Roughness of Joints(Jr)	1
Alteration of Joints(Ja)	1
Water Inflow (Jw)	1
Stress Reduction Factor (SRF)	1
Q - Value	6.25

NATURE OF SUPPORT MEASURE APPLIED

SUPPORT MEASURES	
Shotcrete	
SFRS	✓
Wiremesh	
Rock Bolts	✓
Ribs	
Grouting	
Backfilling	
Other's	

Discontinuities Details:- strike/dipamt/dip

J ₁	J ₂	J ₃	J _R	J _R
200/33/110	047/54/317	087/85/357	122/50/32	

Figure.16 : Facelog 3 showing Q computation

“Rock Mass Classification and Tunnel Supporting Parameters”

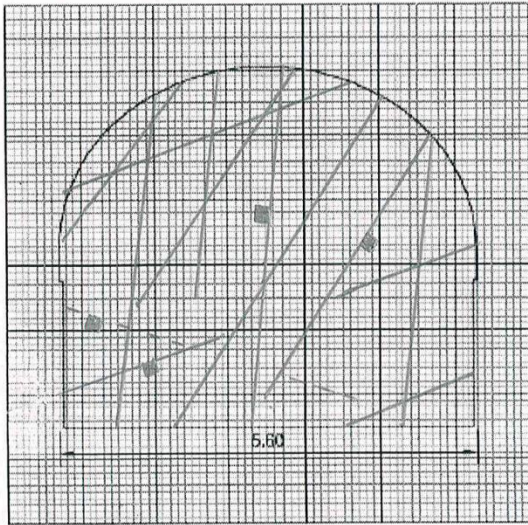

Description:- • ground water condition is dry to damp.

- Spacing of joints is approx 0.8m
- strike of joints set 1 is almost parallel to tunnel axis & its dip amt. is 22 which show fair class for orientation of joint
- It represent fair class of rock

Rock Mass Class	V.Good	Good	Fair	Poor	V.Poor	Ext.Poor
			✓			

NATURE OF SUPPORT MEASURE APPLIED

SUPPORT MEASURES	
Shotcrete	
SFRS	✓
Wire mesh	
Rock Bolts	✓
Ribs	
Grouting	
Backfilling	
Other's	

Computation of Rock Classification (RMR)	
Features	Rating
UCS	12
RQD	13
Spacing of Discontinuities	15
Condition of discontinuities	10
Groundwater Conditions	10
Orientation of Discontinuities	-5
RMR	55

Discontinuities Details: strike/dip amt/dip

J ₁	J ₂	J ₃	J _p
200/33/110	047/54/317	087/85/357	122/50/32

Figure.17 : Facelog 3 showing RMR computation

“Rock Mass Classification and Tunnel Supporting Parameters”

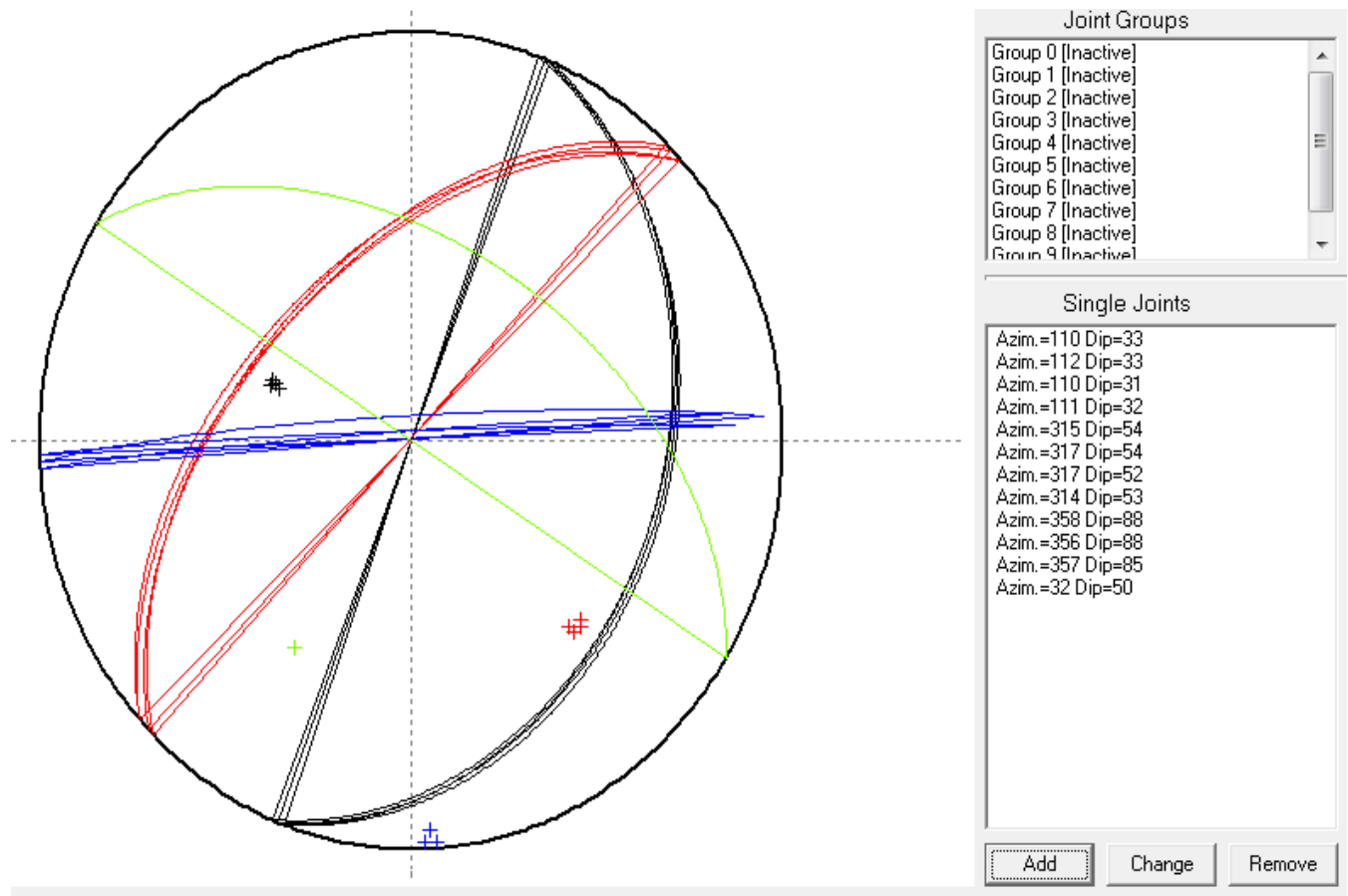

Figure.18 ; Stereonet of Facelogs 3

Calculation of RQD

$$RQD = 115 - 3.3J_v \quad (J_v = 12)$$

$$RQD = (115 - 3.3 \times 12)$$

$$RQD = 75\%$$

Support Recommendation

Rock bolts and Shotcrete are required to support the excavated span.

Length of Rock bolts = 2.5m and SFRS (Steel Fibre Reinforced Shotcrete) are required to be used.

"Rock Mass Classification and Tunnel Supporting Parameters"

Facelog 4 RMR and Q calculation Tunnel Drive : 195 Degree (N15E & S15W)

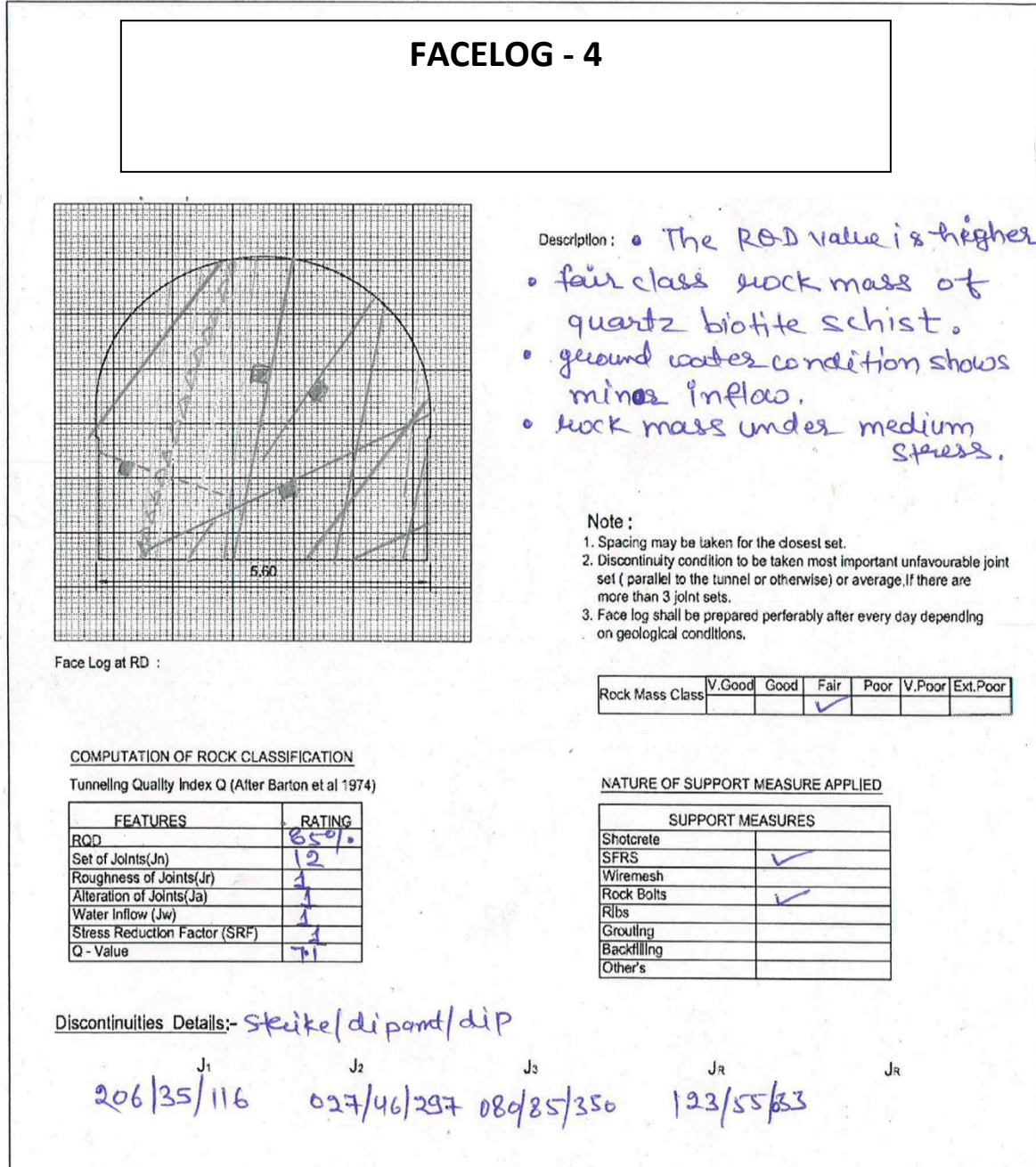
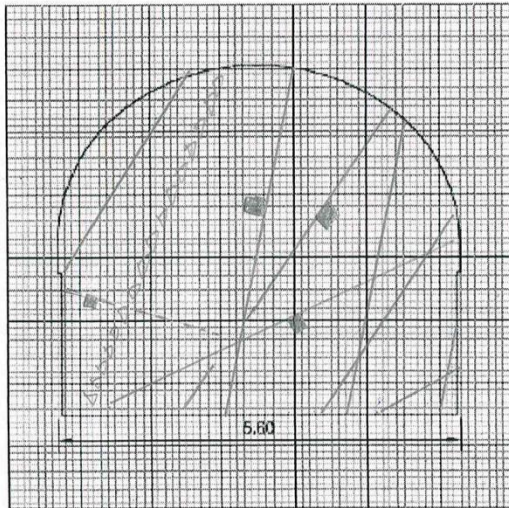

Figure.19 : Facelog 4 showing Q computation

"Rock Mass Classification and Tunnel Supporting Parameters"



Description:- ground water condition is damp to wet,
 • RQD value represent higher,
 • Spacing between joint is more as compare to previous ~~face~~ faces
 • fair class rock mass of quartz biotite schist.

Rock Mass Class	V.Good	Good	Fair	Poor	V.Poor	Ext.Poor
			✓			

NATURE OF SUPPORT MEASURE APPLIED

SUPPORT MEASURES	
Shotcrete	
SFRS	✓
Wiremesh	
Rock Bolts	✓
Ribs	
Grouting	
Backfilling	
Other's	

Computation of Rock Classification (RMR)	
Features	Rating
UCS	12
RQD	17
Spacing of Discontinuities	15
Condition of discontinuities	10
Groundwater Conditions	7
Orientation of Discontinuities	-5
RMR	56

Discontinuities Details: strike/dip amt/dip

J_1 206/35/116
 J_2 027/46/297
 J_3 080/85/350
 J_R 123/55/033

Figure.20 : Facelog 4 showing RMR computation

“Rock Mass Classification and Tunnel Supporting Parameters”

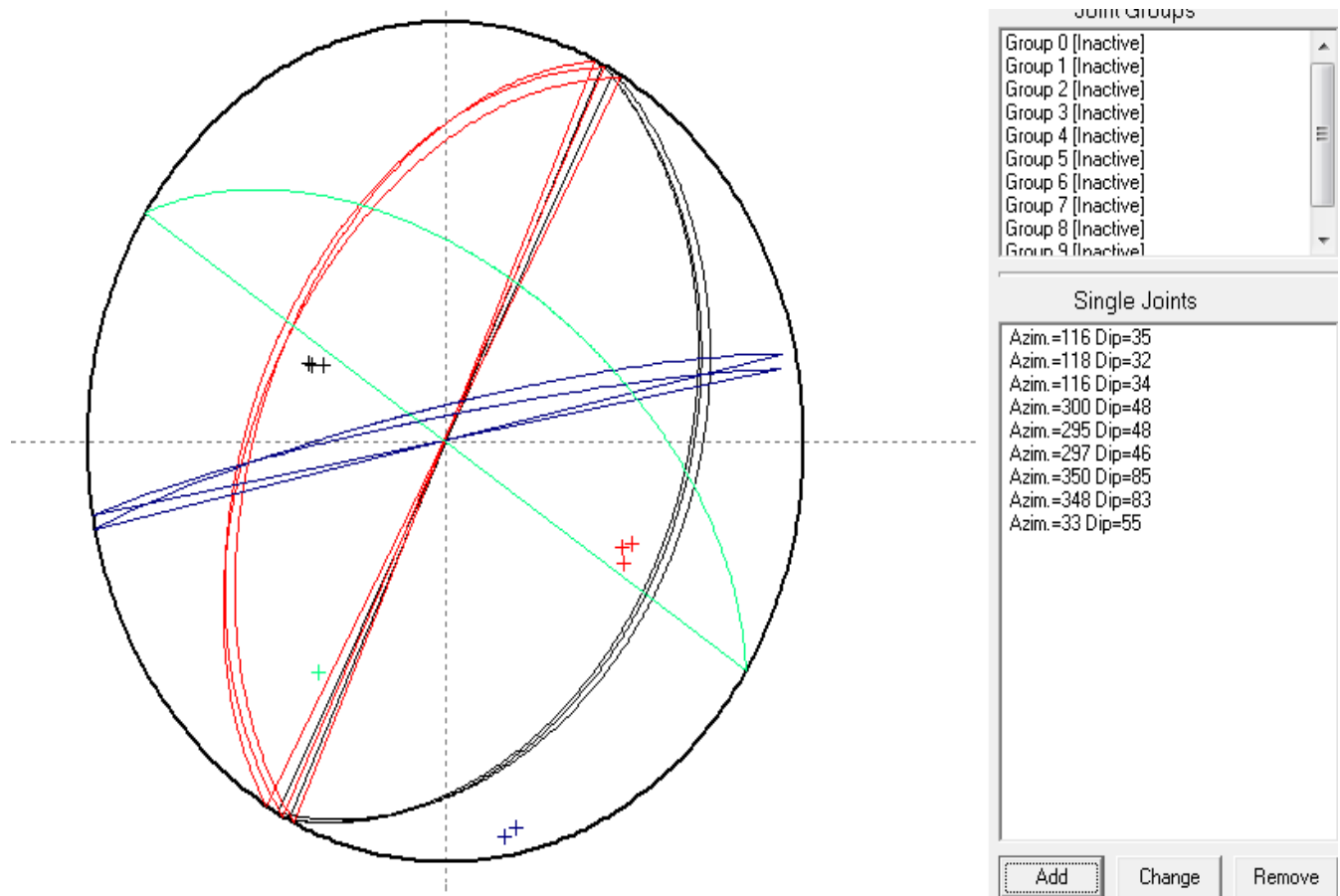

Figure.21 ; Stereonet of Facelog 4

Calculation of RQD

$$RQD = 115 - 3.3J_v \quad (J_v = 9)$$

$$RQD = (115 - 3.3 \times 9)$$

$$RQD = 85\%$$

Support Recommendation

Rock bolts and Shotcrete are required to support the excavated span.

Length of Rock bolts = 2.5m and SFRS (Steel Fibre Reinforced Shotcrete) are required to be used.

Facelog 5
RMR and Q calculation
Tunnel Drive : 195 Degree (N15E & S15W)

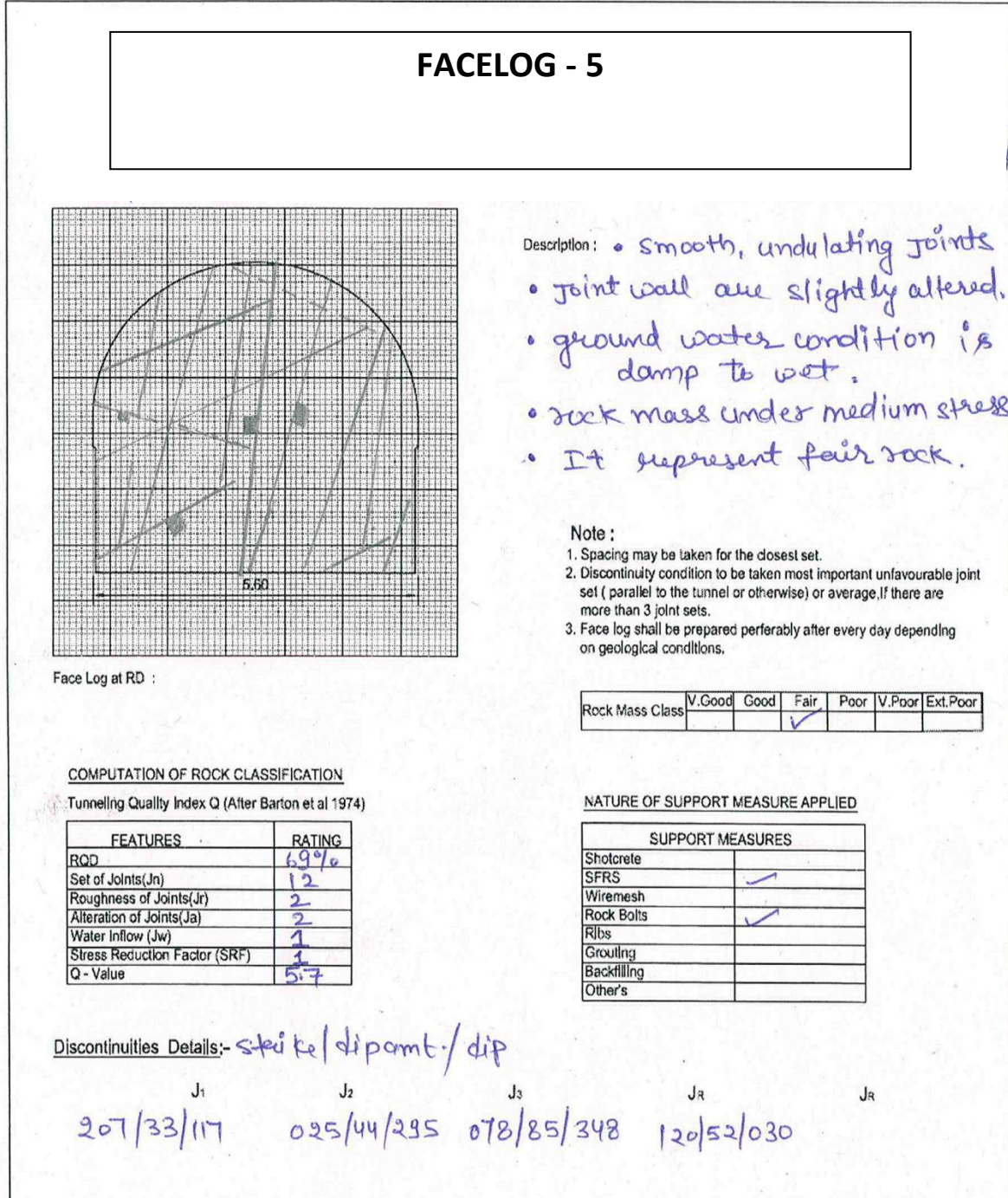
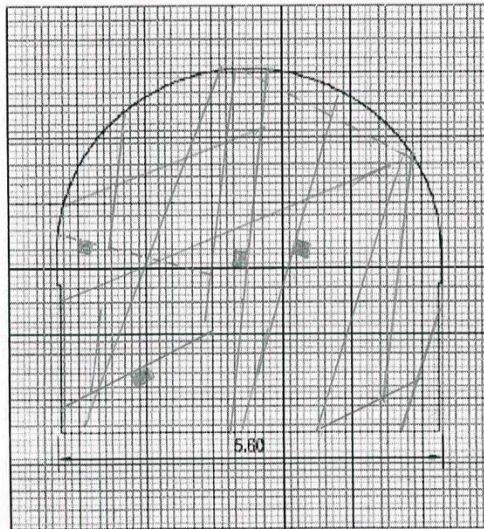

Figure.22 : Facelog 5 showing Q computation

"Rock Mass Classification and Tunnel Supporting Parameters"



- Descriptions:
- spacing between joint is small.
 - ground water condition is dry to wet.
 - joints possess slickensided surface.
 - It represent fair class of rock

Rock Mass Class	V.Good	Good	Fair	Poor	V.Poor	Ext.Poor
			✓			

NATURE OF SUPPORT MEASURE APPLIED

SUPPORT MEASURES	
Shotcrete	
SFRS	✓
Wiremesh	
Rock Bolts	✓
Ribs	
Grouting	
Backfilling	
Other's	

Computation of Rock Classification (RMR)	
Features	Rating
UCS	17
RQD	13
Spacing of Discontinuities	8
Condition of discontinuities	10
Groundwater Conditions	10
Orientation of Discontinuities	-5
RMR	53

Discontinuities Details: strike/dip amt/dip

J ₁	J ₂	J ₃	J _R
207/33/117	025/44/295	078/85/348	120/52/030

Figure.23 : Facelog 5 showing RMR computation

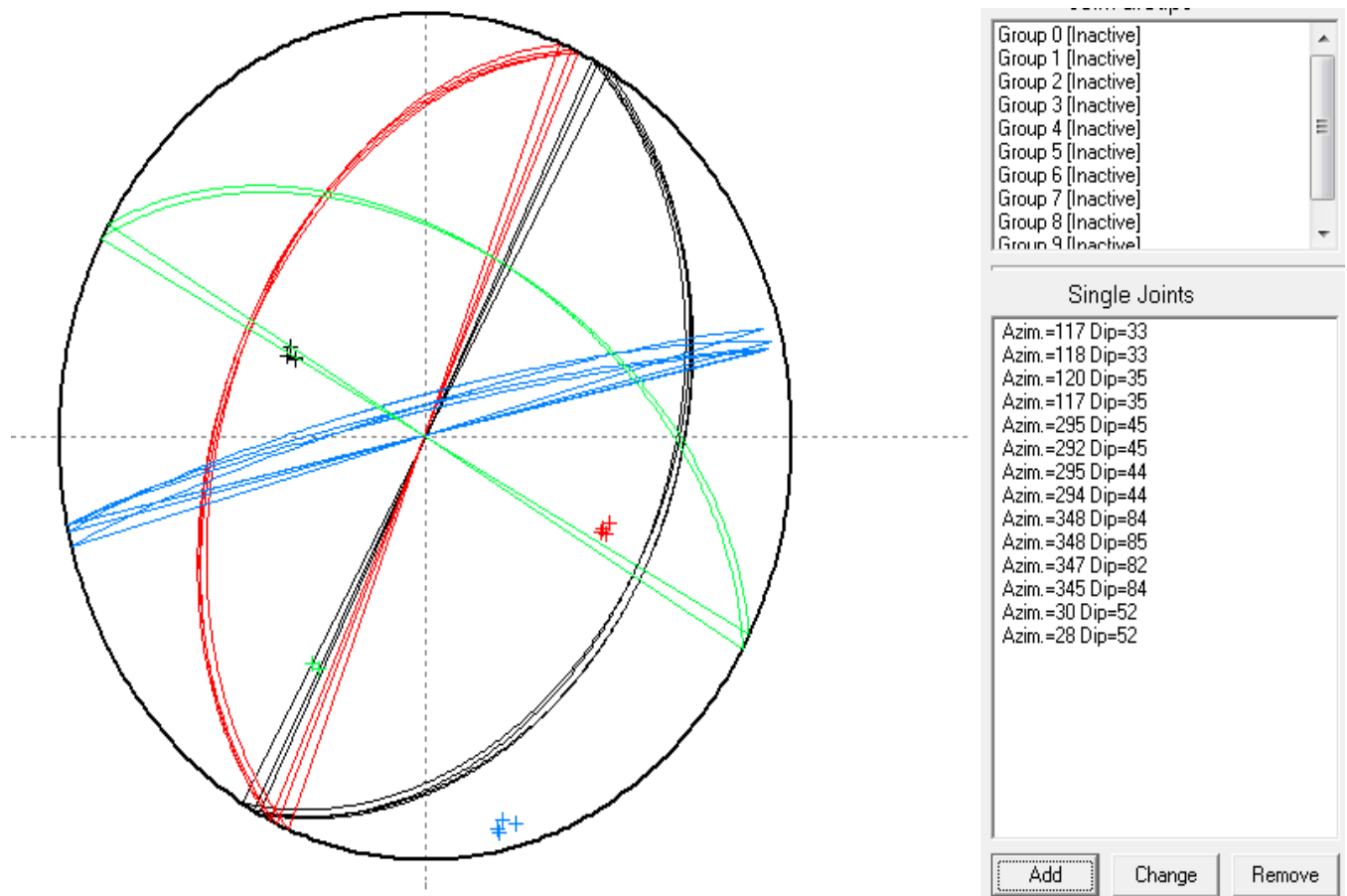

Figure.24 ; Stereonet of Facelog 5

Calculation of RQD

$$RQD = 115 - 3.3J_v \quad (J_v = 14)$$

$$RQD = (115 - 3.3 \times 14)$$

$$RQD = 69\%$$

Support Recommendation

Rock bolts and Shotcrete are required to support the excavated span.

Length of Rock bolts = 2.5m and SFRS (Steel Fibre Reinforced Shotcrete) are required to be used.

CONCLUSION

- RMR and Q systems are used to define quality or class of a rock mass in tunnels. This systems depends upon different parameters such as RQD, roughness, Groundwater condition etc. After class of a Rock mass is defined particular Supporting parameters such as Rock bolts, shotcrete, steel ribs are estimated.
- In SINGOLI-BHATWARI HYDROELECTRIC PROJECT Q- system is used for Rock mass classification. But we have used both RMR and Q-system in a 15m chainage in our project.
- In our observation chainage rock mass is Quartz-Biotite-Schist. Our project consists of 5 Facelogs from five different faces commencing 1510-1525m chainage. At each Face we have use RMR and Q-system to define class or quality of a Rock mass. The value of Q-system varies from 5.7-7.1 and RMR system varies from 45-56.
- The Groundwater condition is generally damp to wet. The joint of rock mass represents smooth and planar surfaces. The whole rock mass is medium stress. The joints are almost unaltered and shows no infilling of clayey material. Dominant joints are almost parallel to tunnel axis which shows fair condition of joints.
- **Supporting parameters** used in our Project are Rock bolts and SFRS (Steel Fibre Reinforced Shotcrete). The length of Rock bolts used is 2.5m and spacing between rock bolts is 1.5-2m. A Shotcrete spray of 50-100mm thick in crown and 30mm thick in side wall is applied.
- **Hence we concluded that the Rock mass belongs to Fair class after using both systems of Rock mass classification.**

REFERENCES

- Barton, N.R., Lien, R. and Lunde, J. 1974. Engineering classification of rock masses for the design of tunnel support. *Rock Mech.* 6(4), 189-239.
- Bieniawski, Z.T. 1976. Rock mass classification in rock engineering. In *Exploration for rock engineering, proc. of the symp.*, (ed. Z.T. Bieniawski) 1, 97-106. Cape Town: Balkema.
- Deere, D.U. and Deere, D.W. 1988. The rock quality designation (RQD) index in practice. In *Rock classification systems for engineering purposes*, (ed. L. Kirkaldie), ASTM Special Publication 984, 91-101. Philadelphia: Am. Soc. Test.Mat.
- Barton, N., Løset, F., Lien, R. and Lunde, J. 1980. Application of the Q-system in design decisions. In *Subsurface space*, (ed. M. Bergman) 2, 553-561. New York: Pergamon.
- Kumar, N. (2002). *Rock mass characterisation and evaluation of supports for tunnels in Himalaya*. PhD thesis, Water Resources Development Training Centre, IIT Roorkee, India, 295.
- Deere, D.U. 1989. *Rock quality designation (RQD) after 20 years*. U.S. Army CorpsEngrs Contract Report GL-89-1. Vicksburg, MS: Waterways Experimental Station.